

APR 2024

CLEAR
DESIGN

PRICE LIST

TABLE OF CONTENTS

BLADE

Legs	1
Panels	4
Supports	6
Wire Management	7

BOOST

Bridges	9
Height-Adjustable Frames	12
Wire Management	13

BOOST PRO

Bridge-Mounted Dividers	15
Frame Components	16
Panels	18
Power	19
Wire Management	22

EDGE

Desks	23
FAST Program	26
Height-Adjustable	27
Storage	28

THREE60

Bases	31
Legs	32
Surfaces	33
Tables	35

OPTIMA

Accessories	37
Frames	38
Panels	39
Power	40
Wire Management	41

COVE

Pods	43
------------	----

KOLAB

Lounge Seating	45
----------------------	----

SEATING

Accessories	47
Conference Chairs	48
Nesting Chairs	49
Side Chairs	50
Stacking Chairs	51
Stools	52
Task Chairs	53

SURFACES

FAST Program	55
FX Program	58

TABLES

Bases	81
Laptop Table	82
Legs	83

PANELS

Brackets	85
End Panels	86
Modesty Panels	88

DIVIDERS

Acrylic (Clear)	91
Acrylic (Frosted)	93
Brackets	95
Fabric	97
Glass	101
PET	104

STORAGE

Laminate	105
Steel	109

POWER

Connector Blocks	115
Duplexes	116
Harnesses	117
Infeeds	118
Jumpers	119
Wire Management	120

SUPPORTS

Supports	123
----------------	-----

ACCESSORIES

Monitor Arm	125
Power & Data Units	126
Storage Hook	128

WILLOW PARK

Acacia Series	129
Campano Collection	135
Lounge Tables	140

BLADE LEGS

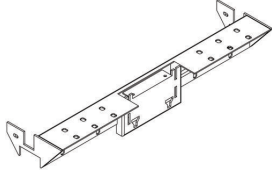
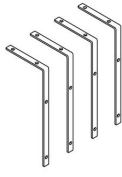
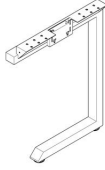
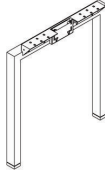
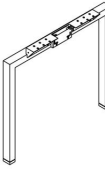


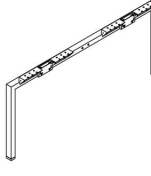

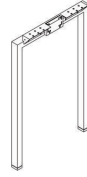
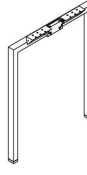

IMAGE	CODE	DESCRIPTION	LIST
Components 	BLC1 BLK, RAW, SLV, WHT	BLADE Leg Connecting Bracket (V2) W 19.96" D 5.12" H 3.15"	\$90
	KIT-SHSLB BLK, SLV, WHT	BLADE Standing-Height Stability L-Bracket, Set of 4 [Includes Laminate-to-Metal Hardware] W 0.79" D 6.3" H 13.78"	\$72
Legs 	BCLEG BLK, SLV, WHT	BLADE 21.5" C-Leg [27.5" High] W 21.63" D 3.94" H 27.38"	\$257
	BL24 BLK, RAW, SLV, WHT	BLADE 24" End Leg [27.375" High] W 24" D 3.94" H 27.38"	\$257
	BL30 BLK, RAW, SLV, WHT	BLADE 30" End Leg [27.375" High] W 30" D 3.94" H 27.38"	\$269
	BL48 BLK, RAW, SLV, WHT	BLADE 48" End Leg [27.375" High] W 48" D 3.94" H 27.38"	\$385

IMAGE	CODE	DESCRIPTION	LIST
	BL48INT BLK, RAW, SLV, WHT	BLADE 48" Intermediate Leg [27.375" High, Expands to 60" Wide] W 45.51"-52.20" D 5.91" H 27.38"	\$559
	BL60 BLK, RAW, SLV, WHT	BLADE 60" End Leg [27.375" High] W 60" D 3.94" H 38.38"	\$434
	KIT-120 BLK, RAW, SLV, WHT	BLADE 120 Degree Leg [27.5" High, Includes Triangular Box] W 10.04" D 8.69" H 27.38"	\$159
Standing-Height 	BTL24 BLK, RAW, SLV, WHT	BLADE 24" Standing-Height End Leg [38.375" High] W 24" D 3.94" H 38.38"	\$331
	BTL30 BLK, SLV, WHT	BLADE 30" Standing-Height End Leg [38.375" High] W 30" D 3.94" H 38.38"	\$346
	BTL48 BLK, SLV, WHT	BLADE 48" Standing-Height End Leg [38.375" High] W 48" D 3.94" H 38.38"	\$477

BLADE LEGS + PANELS


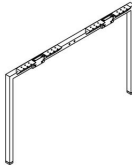
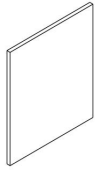
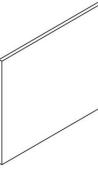
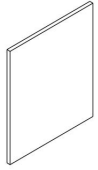
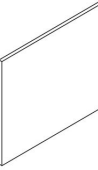
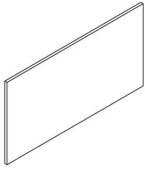
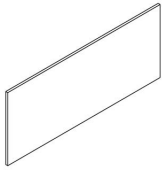
IMAGE	CODE	DESCRIPTION	LIST
	BTL48INT BLK, SLV, WHT	BLADE 48" Standing-Height Intermediate Leg [38.375" High, Expands to 60" Wide] W 45.51"-52.20" D 5.91" H 38.38"	\$677
	BTL60 BLK, SLV, WHT	BLADE 60" Standing-Height End Leg [38.375" High] W 60" D 3.94" H 38.38"	\$507

IMAGE	CODE	DESCRIPTION	LIST
FAST Laminate Inset End Panels 	GBEP20 FFIN2	BLADE 20" Laminate Inset End Panel [23.5" High, 0.75" Thick, For 24" Leg] - FAST W 20" D 0.75" H 23.5"	\$208
	GBEP26 FFIN2	BLADE 26" Laminate Inset End Panel [23.5" High, 0.75" Thick, For 30" Leg] - FAST W 26" D 0.75" H 23.5"	\$227
FX Laminate Inset End Panels 	WABEPIS.A FX	BLADE 20" Laminate Inset End Panel [23.5" High, 0.75" Thick, For 24" Leg] - FX W 20" D 0.75" H 23.5"	\$1483
	WABEPIS.B FX	BLADE 26" Laminate Inset End Panel [23.5" High, 0.75" Thick, For 30" Leg] - FX W 26" D 0.75" H 23.5"	\$1483
	WABEPIS.C FX	BLADE 45" Laminate Inset End Panel [23.5" High, 0.75" Thick, For 48" Leg] - FX W 45" D 0.75" H 23.5"	\$1483
	WABEPIS.D FX	BLADE 56.75" Laminate Inset End Panel [23.5" High, 0.75" Thick, For 60" Leg] - FX W 56.75" D 0.75" H 23.5"	\$1483

BLADE PANELS + SUPPORTS

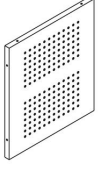
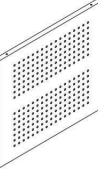
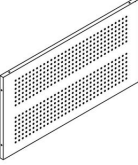
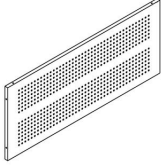
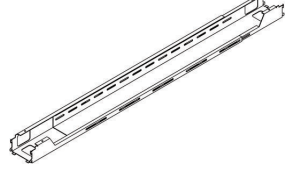
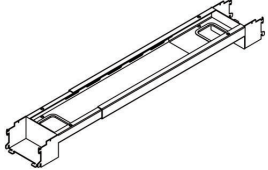
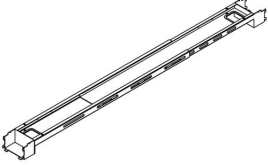
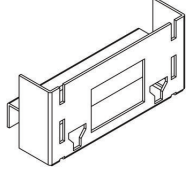
IMAGE	CODE	DESCRIPTION	LIST
Steel Inset End Panels 	BEP24 BLK, SLV, WHT	BLADE 20" Steel Inset End Panel [For 24" Leg] W 20" D 1" H 23.5"	\$220
	BEP30 BLK, SLV, WHT	BLADE 26" Steel Inset End Panel [For 30" Leg] W 26" D 1" H 23.5"	\$242
	BEP48 BLK, SLV, WHT	BLADE 45" Steel Inset End Panel [For 48" Leg] W 45" D 1" H 23.5"	\$252
	BEP60 BLK, SLV, WHT	BLADE 56.75" Steel Inset End Panel [For 60" Leg] W 56.75" D 1" H 23.5"	\$305

IMAGE	CODE	DESCRIPTION	LIST
Beams 	BB3 BLK, SLV, WHT	BLADE Extra Long Beam W 53.5"-87.88" D 4.65" H 2.76"	\$268
	BLPB1 BLK, SLV, WHT	BLADE Short Low Profile Beam W 24.45"-41.14" D 4.65" H 2.76"	\$122
	BLPB2 BLK, SLV, WHT	BLADE Long Low Profile Beam W 40"-69.74" D 4.65" H 2.76"	\$178
Components 	BBC1 SLV	BLADE Beam-to-Beam Connecting Bracket [For L-Shape Workstation] W 5.51" D 1.85" H 2.64"	\$28

BLADE WIRE MANAGEMENT

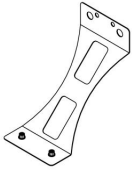
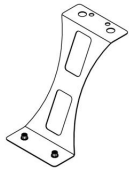
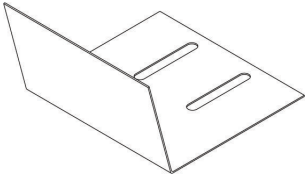
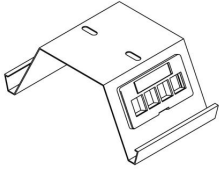
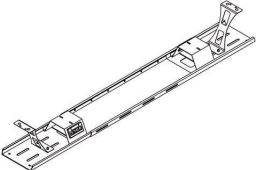
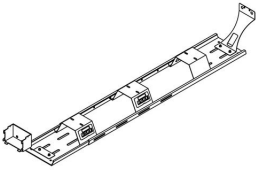
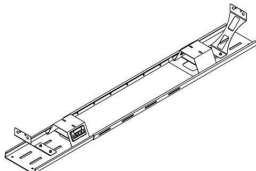
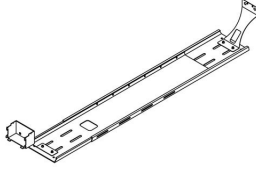
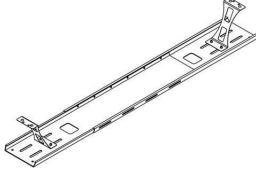
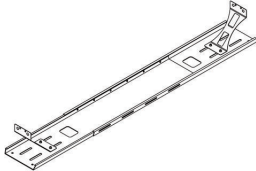
IMAGE	CODE	DESCRIPTION	LIST
Cable Tray Components 	BCTLM BLK, SLV, WHT	BLADE Leg-Mount Cable Tray Hangers, Set of 2 W 3.88" D 6.96" H 2.76"	\$40
	BCTSM BLK, SLV, WHT	BLADE Surface-Mount Cable Tray Hangers, Set of 2 W 3.88" D 5.82" H 6.25"	\$40
	BNTEC BLK, SLV, WHT	BLADE Narrow Cable Tray End Cap W 6.5" D 7" H 3.88"	\$71
	KIT-BNCT-RK BLK, SLV	BLADE Narrow Cable Tray Riser [Includes 1 Data Faceplate] W 4.17" D 6.96" H 2.76"	\$24
Cable Trays 	KIT-CTXN BLK, SLV, WHT	BLADE Narrow Surface-Mount Cable Tray [Includes Risers & Faceplates] W 41.57"-79.51" D 7.38" H 6.38"	\$280
	KIT-CTXN120 BLK, SLV, WHT	BLADE Narrow 120 Degree Leg-Mount Cable Tray [Includes Risers & Faceplates] W 58.04"-70.04" D 9.81" H 7.88"	\$327

IMAGE	CODE	DESCRIPTION	LIST
	KIT-CTXNL BLK, SLV, WHT	BLADE Narrow Leg-Mount Cable Tray [Includes Risers & Faceplates] W 43.64"-80.3" D 7.38" H 6.38"	\$280
Cable Trays - No Data 	KIT-CTXN120ND BLK, SLV, WHT	BLADE Narrow 120 Degree Leg-Mount Cable Tray W 58.04"-70.04" D 9.81" H 7.88"	\$258
	KIT-CTXNLND BLK, SLV, WHT	BLADE Narrow Leg-Mount Cable Tray W 43.64"-80.3" D 7.38" H 6.38"	\$234
	KIT-CTXNND BLK, SLV, WHT	BLADE Narrow Surface-Mount Cable Tray W 41.57"-79.51" D 7.38" H 6.38"	\$234

BOOST BRIDGES

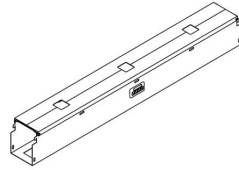
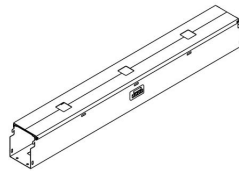
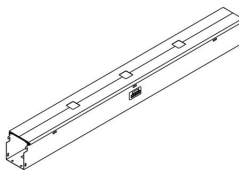
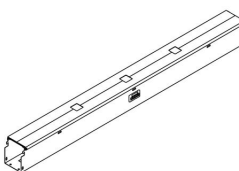
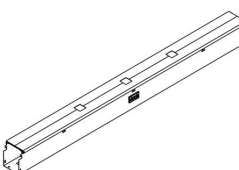
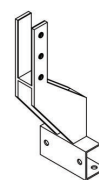
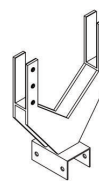
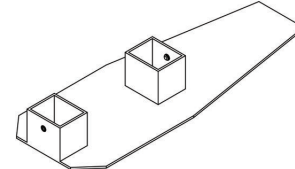
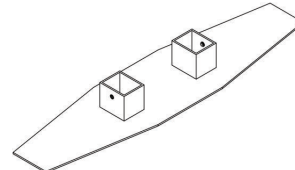
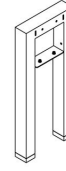
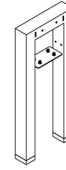
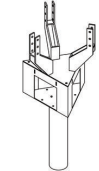
IMAGE	CODE	DESCRIPTION	LIST
Beams 	KIT-BBB120V2 BLK, SLV, WHT	BOOST 46.5" Bridge Beam (V2) [Includes Faceplates, For 120 Degree Workstation] W 48.46" D 5" H 6.28"	\$284
	KIT-BBB48V2 BLK, SLV, WHT	BOOST 49" Bridge Beam (V2) [Includes Faceplates, For 48" Workstation] W 50.93" D 5" H 6.28"	\$298
	KIT-BBB60V2 BLK, SLV, WHT	BOOST 61" Bridge Beam (V2) [Includes Faceplates, For 60" Workstation] W 62.93" D 5" H 6.28"	\$364
	KIT-BBB66V2 BLK, SLV, WHT	BOOST 67" Bridge Beam (V2) [Includes Faceplates, For 66" Workstation] W 68.93" D 5" H 6.28"	\$399
	KIT-BBB72V2 BLK, SLV, WHT	BOOST 73" Bridge Beam (V2) [Includes Faceplates, For 72" Workstation] W 75" D 5" H 6.28"	\$436
Divider Supports 	BBEPBV2 BLK, SLV, WHT	BOOST Bridge End Leg Divider Bracket (V2) W 4.37" D 3.43" H 10.51"	\$72

IMAGE	CODE	DESCRIPTION	LIST
	BBIPBV2 BLK, SLV, WHT	BOOST Bridge Intermediate Leg Divider Bracket (V2) W 7.87" D 3.43" H 10.51"	\$108
	BBLABV2 BLK, SLV, WHT	BOOST Bridge Asymmetric Leg Base (V2) W 16.3" D 6" H 2"	\$115
	BBLBV2 BLK, SLV, WHT	BOOST Bridge Leg Base (V2) W 24" D 6" H 2"	\$115
Legs 	BBENDV2 BLK, SLV, WHT	BOOST Bridge End Leg (V2) W 8.31" D 2.15" H 19.92"	\$186
	BBINTV2 BLK, SLV, WHT	BOOST Bridge Intermediate Leg (V2) W 8.31" D 2.32" H 19.92"	\$183
	KIT-120DB BLK, SLV, WHT	BOOST Bridge 120 Degree Leg [Includes Bridge 120 Degree Leg Divider Bracket] W 11.82" D 10.94" H 29"	\$403

BOOST BRIDGES + HEIGHT-ADJUSTABLE FRAMES

IMAGE	CODE	DESCRIPTION	LIST
	KIT-BB120L BLK, SLV, WHT	BOOST Bridge 120 Degree Leg [Includes Triangular Box] W 10.24" D 8.86" H 19.92"	\$299

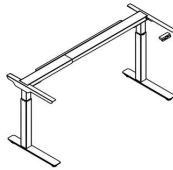
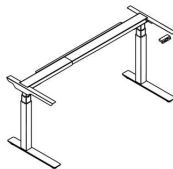
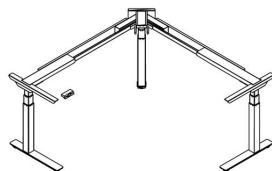
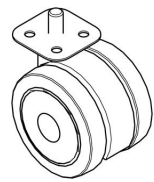
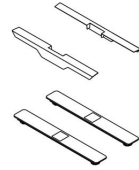
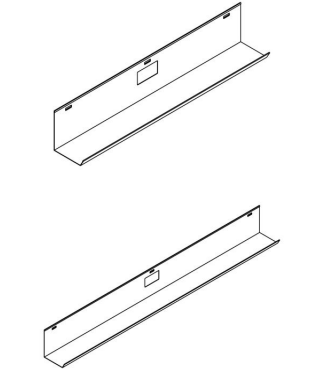
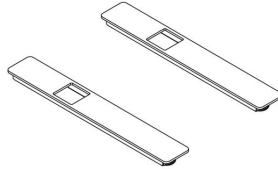
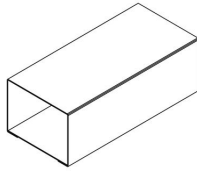
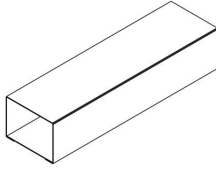
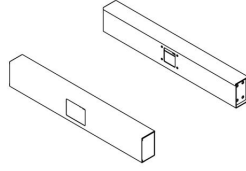
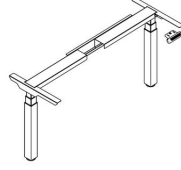
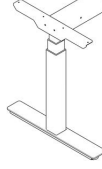
IMAGE	CODE	DESCRIPTION	LIST
2 Stage 	BHA2GSA BLACK, SLV, WHT	BOOST Height-Adjustable C-Leg Frame (2-Stage) [24" Deep, For Stand-Alone Workstation] W 46.75"-70.25" D 24" H 27"-44.5"	\$1610
3 Stage 	BHA3GSA BLACK, SLV, WHT	BOOST Height-Adjustable C-Leg Frame (3-Stage) [24" Deep, For Stand-Alone Workstation] W 46.75"-70.25" D 24" H 25.5"-51"	\$1899
	BHALGSA BLACK, SLV, WHT	BOOST Height-Adjustable 3-Leg Frame (3-Stage) [24" Deep, For L-Shape & 120 Degree Workstations] W 46.75"-70.25" D 46.75"-70.25" H 25.5"-51"	\$3107
Accessories 	BHACAST BLK	BOOST Caster Kit, Set of 4 [Locking, For Straight Frames] W 2.88" D 2.5" H 3.38"	\$131
Electrical	BHAGSAEXT BLK	BOOST Frame Extension Cord [55" Cord, For All GSA Frames] W 55"	\$68
Supports 	TLEG.ADAPTGSA BLACK, SLV, WHT	BOOST Height-Adjustable T-Leg Adapter, Set of 2 (3-Stage) W 6.32" D 24" H 2.69"	\$249

IMAGE	CODE	DESCRIPTION	LIST
Bridge-Mounted Cable Trays	BBCT30 BLK, SLV, WHT	BOOST 30" Bridge Cable Tray [For 48" & 120 Degree Workstations] W 30" D 4.84" H 5.47"	\$118
	BBCT50 BLK, SLV, WHT	BOOST 50" Bridge Cable Tray [For 60"-72" Workstations] W 50" D 4.84" H 5.47"	\$177

BOOST PRO BRIDGE-MOUNTED DIVIDERS + FRAME COMPONENTS

IMAGE	CODE	DESCRIPTION	LIST
 <p>Divider Supports</p>	BPROBRK BLK, SLV, WHT	BOOST Pro Beam-Mounted Divider Clippers, Set of 2 W 3" D 3.63" H 9.44"	\$149
	BPROMBRG BLK	Rubber Shim [For Boost Pro Divider Clipper] W 0.5" D 2" H 8.25"	\$21

IMAGE	CODE	DESCRIPTION	LIST
 <p>Frame Components</p>	BPRO24F BLK, SLV, WHT	BOOST Pro 24" C-Leg Feet, Set of 2 [For Single-Sided Workstations] W 3.54" D 23.62" H 1.5"	\$185
	BPROBRG1 BLK, SLV, WHT	BOOST Pro 7.5" Power Beam Connector [For 48"-66" Workstations] W 7.5" D 3.5" H 2.6"	\$32
	BPROBRG2 BLK, SLV, WHT	BOOST Pro 12.25" Power Beam Connector [For 72" Workstations] W 12.25" D 3.5" H 2.6"	\$38
	BPROCB BLK, SLV, WHT	BOOST Pro Cross Beam, Set of 2 [Includes Side Covers, For Facing Workstations] W 25.13" D 2.44" H 4"	\$271
	BPROF BLK, SLV, WHT	BOOST Pro Height-Adjustable Frame [For 48"-72" Workstations] W 46.75"-66" D 19.68" H 25.4"-51"	\$1563
	BPROLF BLK, SLV, WHT	BOOST Pro Height-Adjustable L-Shape Frame Adapter Kit W 13.86" D 19.68" H 25.4"-51"	\$1045

BOOST PRO FRAME COMPONENTS + PANELS

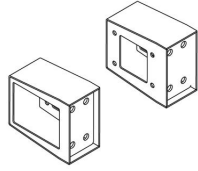
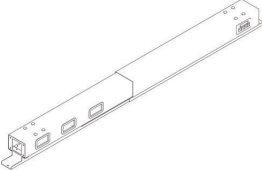
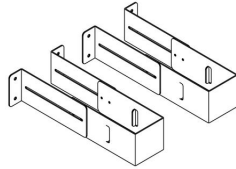
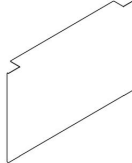
IMAGE	CODE	DESCRIPTION	LIST
	BPROSRB BLK, SLV, WHT	BOOST Pro Power Beam Mounting Brackets, Set of 2 [For Single-Sided Workstations] W 2.38" D 4.63" H 3.94"	\$95
	KIT-BPROTPB BLK, SLV, WHT	BOOST Pro Expandable Power Beam and Data Tray [Includes Faceplates, Trim Plates, and Covers For Cutouts] W 42.63"-60.63" D 4" H 2.88"	\$535

IMAGE	CODE	DESCRIPTION	LIST
Laminate End Panel Brackets 	BPROAEPB BLK, SLV, WHT	BOOST Pro Adjustable Panel Bracket, Set of 2 [For Laminate Panels]	\$225
Steel End Panel 	BPROEP BLK, SLV, WHT	BOOST Pro Steel End Panel W 30.63" D 2.36" H 18.54"	\$114

BOOST PRO POWER

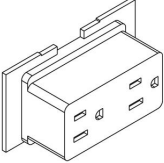
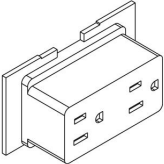
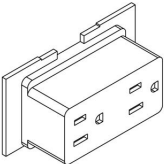
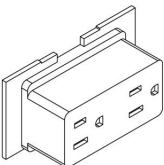
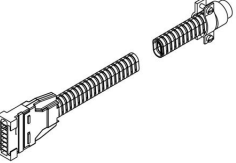
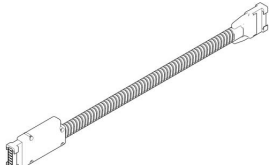
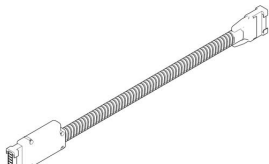


IMAGE	CODE	DESCRIPTION	LIST
Duplexes 	PROR1 BLK	BOOST Pro Duplex Receptacle Circuit 1 W 3.44" D 1.25" H 1.81"	\$48
	PROR2 BLK	BOOST Pro Duplex Receptacle Circuit 2 W 3.44" D 1.25" H 1.81"	\$48
	PROR3 BLK	BOOST Pro Duplex Receptacle Circuit 3 W 3.44" D 1.25" H 1.81"	\$48
	PROR4 BLK	BOOST Pro Duplex Receptacle, Controlled, Circuit 4 W 3.44" D 1.25" H 1.81"	\$48
Infeeds	PROIF144 SLV	BOOST Pro 144" In-feed W 144" D 0.81" H 2"	\$494
	PROIF72 SLV	BOOST Pro 72" In-feed W 72" D 0.81" H 2"	\$355

IMAGE	CODE	DESCRIPTION	LIST
	PROIFNYC SLV	BOOST Pro 15.5" NYC In-feed	\$493
Jumpers 	PROJ44 SLV	BOOST Pro 44" Jumper W 44" D 0.81" H 2"	\$248
	PROJ49 SLV	BOOST Pro 49" Jumper W 49" D 0.81" H 2"	\$256
	PROJ55 SLV	BOOST Pro 55" Jumper W 55" D 0.81" H 2"	\$284
	PROJ61 SLV	BOOST Pro 61" Jumper W 61" D 0.81" H 2"	\$301
Power Blocks	PROBC BLK	BOOST Pro In-Line Power Block Connector W 1.75" D 0.82" H 2.13"	\$42
	PRODB BLK	BOOST Pro Double Power Block W 11.38" D 3.69" H 2.56"	\$230

BOOST PRO POWER + WIRE MANAGEMENT

IMAGE	CODE	DESCRIPTION	LIST
	PROSB BLK	BOOST Pro Single Power Block W 5.31" D 3.69" H 2.56"	\$159

IMAGE	CODE	DESCRIPTION	LIST
Infeed Management 	KIT-BPROPP3 BLK, SLV, WHT	144" Power Pole, 3-Piece [For Boost Pro, Includes bracket and Trim Plate] W 3.18" D 1.6" H 144"	\$404
	KIT-BPROPP4 BLK, SLV, WHT	144" Power Pole, 2-Piece [For Boost Pro, Includes bracket and Trim Plate] W 3.18" D 1.6" H 144"	\$404

EDGE DESKS

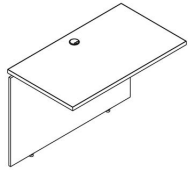
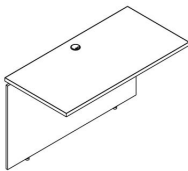
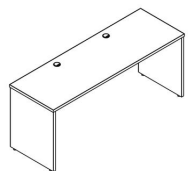
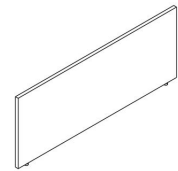
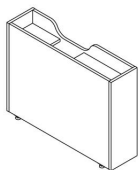
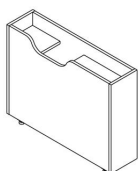
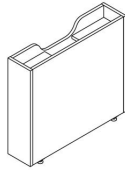
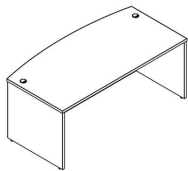
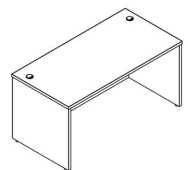
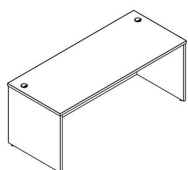
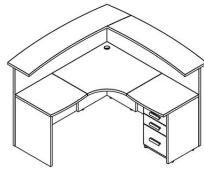
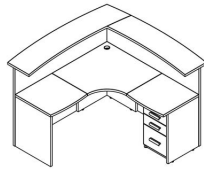
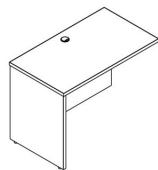
IMAGE	CODE	DESCRIPTION	LIST
Bridges 	EGF2441 ELM1, OAK1, SAH1	EDGE 24"x41" Bridge with Full Modesty Panel [Includes 1 Pre-Installed Grommet] W 41" D 24" H 29.44"	\$806
	EGF2447 ELM1, OAK1, SAH1	EDGE 24"x47" Bridge with Full Modesty Panel [Includes 1 Pre-Installed Grommet] W 47" D 24" H 29.44"	\$854
Credenzas 	ECH2472 ELM1, OAK1, SAH1	EDGE 24"x72" Credenza Shell with Half Modesty Panel [Includes 2 Pre-Installed Grommets] W 72" D 23.75" H 29.44"	\$1472
EDGE Height Adjustable Desk 	ESHAFP72 ELM1, OAK1, SAH1	EDGE Fixed Modesty Panel [For 72" Height-Adjustable Workstation]	\$255
	ESHALC.L ELM1, OAK1, SAH1	EDGE Left-Leg Cover [For Height-Adjustable Workstation]	\$468
	ESHALC.R ELM1, OAK1, SAH1	EDGE Right-Leg Cover [For Height-Adjustable Workstation]	\$468

IMAGE	CODE	DESCRIPTION	LIST
	ESHARLC ELM1, OAK1, SAH1	EDGE Return-Leg Cover [For Height-Adjustable Workstation]	\$461
Main 	EBDF3571 ELM1, OAK1, SAH1	EDGE 35"x71" Bow-Front Desk Shell with Full Modesty Panel [Includes 2 Pre-Installed Grommets] W 71" D 35" H 29.44"	\$1836
	EDF3059 ELM1, OAK1, SAH1	EDGE 30"x59" Desk Shell with Full Modesty Panel [Includes 2 Pre-Installed Grommets] W 59" D 30" H 29.44"	\$1283
	EDF3071 ELM1, OAK1, SAH1	EDGE 30"x71" Desk Shell with Full Modesty Panel [Includes 2 Pre-Installed Grommets] W 71" D 30" H 29.44"	\$1640
Reception 	ERUHK BLK, WHT	EDGE Reception Unit Hardware W 1.18" D 3.93" H 3.93"	\$0.01
	KIT-ERUBBF ELM1, OAK1, SAH1, WHT	EDGE Reception Unit [Includes Transaction Counter and BBF Pedestal] W 66.88" D 66.88" H 45"	\$6452
Returns 	ERF2441.L ELM1, OAK1, SAH1	EDGE 24"x41" Left-Hand Return with Full Modesty Panel [Includes 1 Pre-Installed Grommet] W 41" D 24" H 29.44"	\$1017

EDGE DESKS + FAST PROGRAM

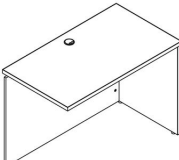
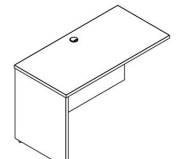
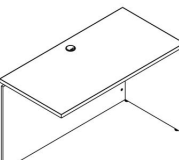
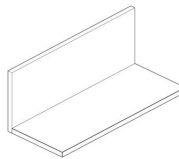

IMAGE	CODE	DESCRIPTION	LIST
	ERF2441.R ELM1, OAK1, SAH1	EDGE 24"x41" Right-Hand Return with Full Modesty Panel [Includes 1 Pre-Installed Grommet] W 41" D 24" H 29.44"	\$1017
	ERF2447.L ELM1, OAK1, SAH1	EDGE 24"x47" Left-Hand Return with Full Modesty Panel [Includes 1 Pre-Installed Grommet] W 47" D 24" H 29.44"	\$1034
	ERF2447.R ELM1, OAK1, SAH1	EDGE 24"x47" Right-Hand Return with Full Modesty Panel [Includes 1 Pre-Installed Grommet] W 47" D 24" H 29.44"	\$1034

IMAGE	CODE	DESCRIPTION	LIST
Accessories 	EFS1436 ELM1, OAK1, SAH1	EDGE 14"x36" Floating Shelf W 36" D 15" H 14"	\$608
Pedestals 	ELMBF ELM1, OAK1, SAH1, WHT	EDGE Laminate Mobile Box File W 16.14" D 17.71" H 23.37"	\$839

EDGE HEIGHT-ADJUSTABLE + STORAGE

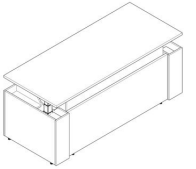
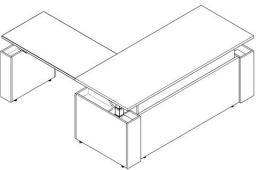
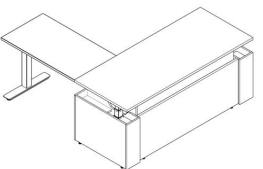
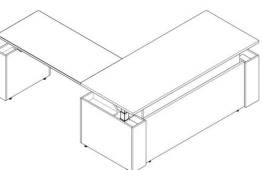
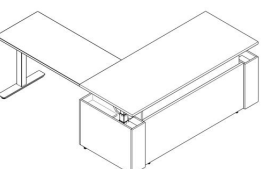

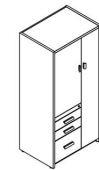
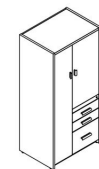
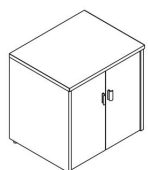
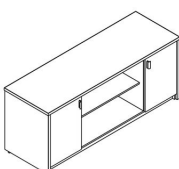
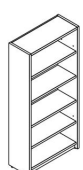
IMAGE	CODE	DESCRIPTION	LIST
TYPICALS 	EHAD3072 ELM1, OAK1, SAH1	EDGE Height Adjustable Straight Desk [30" x 72"] W 72" D 30" H 25.4"-51"	\$4120
	EHAD3072L2442 ELM1, OAK1, SAH1	EDGE Height Adjustable Desk [30" x 72" w/ 24" x 42" Return] W 72" D 72" H 25.4"-51"	\$6087
	EHAD3072L2442-NRLC ELM1, OAK1, SAH1	EDGE Height Adjustable Desk [30" x 72" w/ 24" x 42" Return, No Return Leg Cover] W 72" D 72" H 25.4"-51"	\$5626
	EHAD3072L2448 ELM1, OAK1, SAH1	EDGE Height Adjustable Desk [30" x 72" w/ 24" x 48" Return] W 72" D 78" H 25.4"-51"	\$6144
	EHAD3072L2448-NRLC ELM1, OAK1, SAH1	EDGE Height Adjustable Desk [30" x 72" w/ 24" x 48" Return, No Return Leg Cover] W 72" D 78" H 25.4"-51"	\$5683

IMAGE	CODE	DESCRIPTION	LIST
Free-Standing 	E2DLF ELM1, OAK1, SAH1	EDGE 30" Laminate 2-Drawer Lateral File [29" High] W 29.68" D 24.71" H 29.44"	\$2671
	E3DWC.L ELM1, OAK1, SAH1	EDGE 33" Left-Hand Laminate 3-Drawer Wardrobe Cabinet [71" High] W 33.22" D 24.79" H 70.82"	\$3964
	E3DWC.R ELM1, OAK1, SAH1	EDGE 33" Right-Hand Laminate 3-Drawer Wardrobe Cabinet [71" High] W 33.22" D 24.79" H 70.82"	\$3964
	ED2C30 ELM1, OAK1, SAH1	EDGE 30" Laminate 2-Door Cabinet [29" High] W 29.68" D 24.28" H 29.44"	\$1865
	ED2CS ELM1, OAK1, SAH1	EDGE 72" Laminate 2-Door Credenza with Open Shelf [30" High] W 71.02" D 24.57" H 29.13"	\$3368
	ELB1471 ELM1, OAK1, SAH1	EDGE 33" Laminate 5-High Bookcase [71" High] W 33" D 14" H 71"	\$2295

EDGE STORAGE

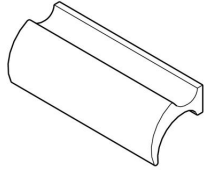
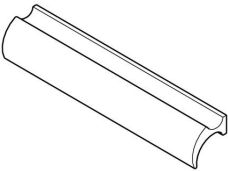
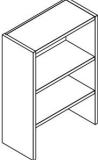
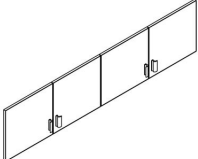
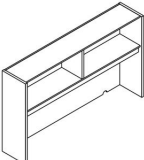
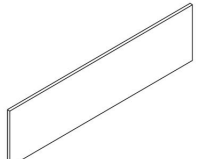
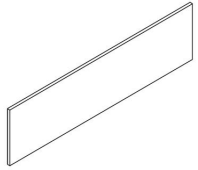


IMAGE	CODE	DESCRIPTION	LIST
Hardware 	LSP3 BLK, SLV, WHT	3.16" Laminate Storage Pull W 3.16" D 1.13" H 1"	\$27
	LSP6 BLK, SLV, WHT	6.3" Laminate Storage Pull W 6.3" D 1.13" H 1"	\$27
Hutches 	E2SH ELM1, OAK1, SAH1	EDGE 29" Laminate 2-Shelf Open Hutch [41" High] W 28.75" D 13.87" H 41.31"	\$1697
	EDK70 ELM1, OAK1, SAH1	EDGE Laminate Hutch Door Kit, Set of 4 [16.5" High, For 70" Open Hutch] W 16.81" D 0.63" H 16.5"	\$483
	EH70S ELM1, OAK1, SAH1	EDGE 70" Laminate Open Hutch [41" High] W 70.07" D 13.85" H 41.33"	\$3288
	GBT1868 BLU, GRY, TPE	68" Fabric Tackboard [18" High] W 68" H 18"	\$544

IMAGE	CODE	DESCRIPTION	LIST
	GBT1868.FXCOM FX-Bryant Park or COM	68" Fabric Tackboard [18" High, Requires 2.5 Yards] - FX/COM W 68" H 18"	\$970
Surface-Supporting 	EBBFSS ELM1, OAK1, SAH1	EDGE Laminate Box/Box/File Surface-Supporting Pedestal W 15.94" D 18.68" H 28.34"	\$1407
	EFFSS ELM1, OAK1, SAH1	EDGE Laminate File/File Surface-Supporting Pedestal W 15.94" D 18.68" H 28.34"	\$1327

THREE60 BASES + LEGS

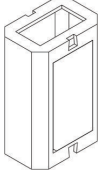
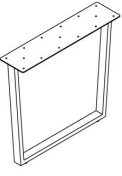
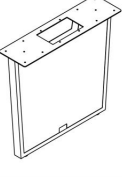
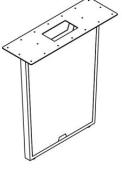
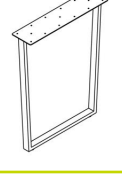

IMAGE	CODE	DESCRIPTION	LIST
Cabinet Base 	CNCBV2 CNCBV2	THREE60 Cabinet Base (V2) - FAST W 17.72" D 11.81" H 27.36"	\$650

IMAGE	CODE	DESCRIPTION	LIST
Legs 	GCNAB BLK, SLV, WHT	THREE60 Angled Sleigh Leg W 30" D 7.28" H 27.36"	\$781
	GCNABCOV BLK, SLV, WHT	THREE60 Angled Sleigh Leg [Covered For Wire Management] W 30" D 7.28" H 27.36"	\$861
Standing-Height Legs 	GCNABCOVSH BLK, SLV, WHT	THREE60 Standing-Height Angled Sleigh Leg [Covered For Wire Management] W 35" D 11.81" H 38.39"	\$1112
	GCNABSHV2 BLK, SLV, WHT	THREE60 Standing-Height Angled Sleigh Leg (V2) W 30" D 7.28" H 38.39"	\$905
Support Brace 	GCNABSHLE BLK, SLV, WHT	THREE60 Support Brace [For Standing-Height Angled Sleigh Leg] W 3" D 26.34" H 38.11"	\$265

THREE60 SURFACES

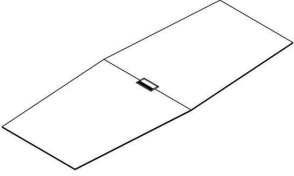
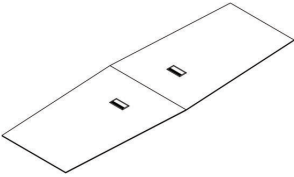
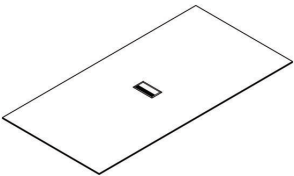
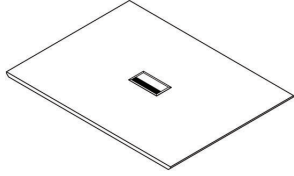
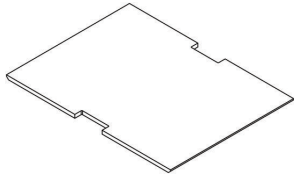
IMAGE	CODE	DESCRIPTION	LIST
2-Piece 	CNS48120 ELM1, OAK1, SAH1, WHT	THREE60 48"x120" Trapezoid Surface, 2-Piece [Includes Knife Edge & 1 Grommet] - FAST W 120" D 48" H 1"	\$1704
	CNS48144 ELM1, OAK1, SAH1, WHT	THREE60 48"x144" Trapezoid Surface, 2-Piece [Includes Knife Edge & 2 Grommets] - FAST W 144" D 48" H 1"	\$2020
	CNS4896 ELM1, OAK1, SAH1, WHT	THREE60 48"x96" Surface, 2-Piece [Includes Knife Edge & 1 Grommet] - FAST W 96" D 48" H 1"	\$1331
Single Piece 	CNS3672 ELM1, OAK1, SAH1, WHT	THREE60 36"x72" Surface [Includes Knife Edge] - FAST W 72" D 36" H 1"	\$708
	CNS4272 ELM1, OAK1, SAH1, WHT	THREE60 42"x72" Surface [Includes Knife Edge & 1 Grommet] - FAST W 72" D 42" H 1"	\$887
	CNS4284 ELM1, OAK1, SAH1, WHT	THREE60 42"x84" Surface [Includes Knife Edge & 1 Grommet] - FAST W 84" D 42" H 1"	\$1064

IMAGE	CODE	DESCRIPTION	LIST
Spacers 	CNCGB ELM1, OAK1, SAH1, WHT	THREE60 48"x36" Center-Grommet Spacer Surface [Includes Knife Edge & 1 Grommet] - FAST W 36" D 48" H 1"	\$550
	CNSGA ELM1, OAK1, SAH1, WHT	THREE60 48"x36" Split-Grommet Spacer Surface [Includes Knife Edge & 2 Half-Cutouts & 1 Grommet] - FAST W 36" D 48" H 1"	\$570

THREE60 TABLES

IMAGE	CODE	DESCRIPTION	LIST
	KIT-CPT4248 ELM1, OAK1, SAH1, WHT	THREE60 42"x48" Parsons Table [Includes 1 Grommet] - FAST W 48" D 42" H 41.5"	\$1830
	KIT-CPT4272 ELM1, OAK1, SAH1, WHT	THREE60 42"x72" Parsons Table [Includes 2 Grommets] - FAST W 72" D 42" H 41.5"	\$2482
	KIT-CPT4284 ELM1, OAK1, SAH1, WHT	THREE60 42"x84" Parsons Table [Includes 2 Grommets] - FAST W 84" D 42" H 41.5"	\$2713

OPTIMA ACCESSORIES + FRAMES

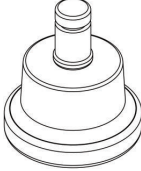


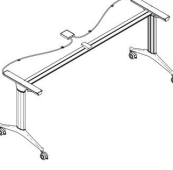
IMAGE	CODE	DESCRIPTION	LIST
	KIT-OTG BLK	OPTIMA Training Table Glide Kit, Set of 4 W 2" D 2" H 2.25"	\$156

IMAGE	CODE	DESCRIPTION	LIST
	OTF48V2 BLK, SLV	OPTIMA 48" Training Table Frame (V2) W 47" D 23" H 28.25"	\$1063
	OTF60V2 BLK, SLV	OPTIMA 60" Training Table Frame (V2) W 59" D 23" H 28.25"	\$1106
	OTF72V2 BLK, SLV	OPTIMA 72" Training Table Frame (V2) W 71" D 23" H 28.25"	\$1143

OPTIMA PANELS + POWER

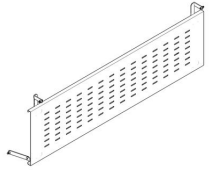
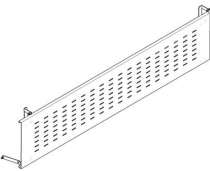
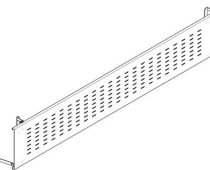
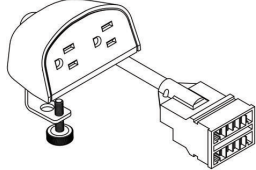
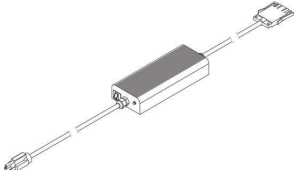
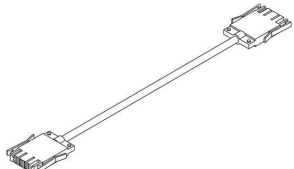
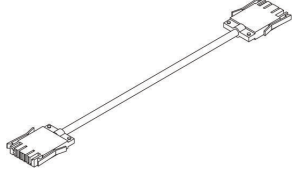
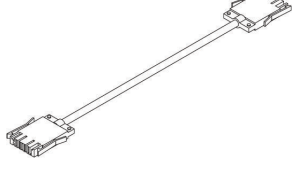
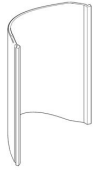
IMAGE	CODE	DESCRIPTION	LIST
Modesty Panels 	OMP48 BLK, SLV	OPTIMA 44" Modesty Panel [For 48" Table] W 46.5" D 0.625" H 12"	\$247
	OMP60 BLK, SLV	OPTIMA 54" Modesty Panel [For 60" Table] W 58.5" D 0.625" H 12"	\$289
	OMP72 BLK, SLV	OPTIMA 68" Modesty Panel [For 72" Table] W 70.5" D 0.625" H 12"	\$332

IMAGE	CODE	DESCRIPTION	LIST
Desktop 	PSMA BLK	OPTIMA Desktop Power Unit [2 Outlets, 24" Cord] W 3.5" D 2.5" H 2"	\$363
Infeed 	PSPIF144 BLK	OPTIMA 114" In-Feed W 114" D 0.75" H 1.75"	\$1284
Jumpers 	PSJ48 BLK	OPTIMA 48" Jumper [For 48" Table] W 48" D 0.75" H 1.75"	\$164
	PSJ60 BLK	OPTIMA 60" Jumper [For 60" Table] W 60" D 0.75" H 1.75"	\$192
	PSJ72 BLK	OPTIMA 72" Jumper [For 66" & 72" Tables] W 72" D 0.75" H 1.75"	\$202

OPTIMA WIRE MANAGEMENT

IMAGE	CODE	DESCRIPTION	LIST
Wire Management 	OPCM BLK	OPTIMA Cable Clip System, Set of 18 [For Version 2 Frame] W 3" D 1.5" H 4"	\$62

COVE PODS

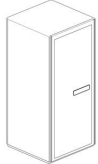
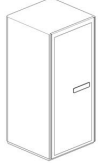

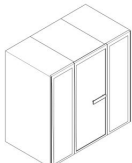
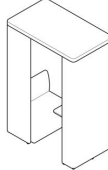
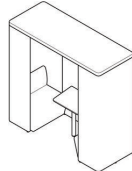
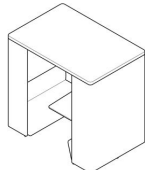
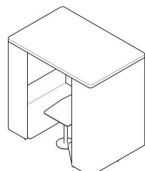
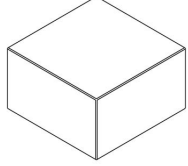
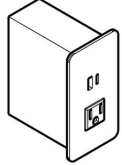
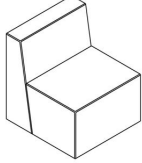
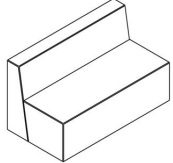
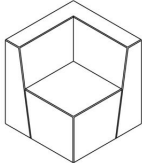
IMAGE	CODE	DESCRIPTION	LIST
	CPOP-MBK MBK, MWT	COVE Focus Pod [Includes Power, Surface, Lighting, Motion Sensor]-Matte Black W 39.375" D 40.938" H 85.813"	\$21854
	CPOP-MWT MBK, MWT	COVE Focus Pod [Includes Power, Surface, Lighting, Motion Sensor]-Matte White W 39.375" D 40.938" H 85.813"	\$21854
	CPRM-MBK MBK, MWT	COVE Room Pod [Includes Power, Lighting, Motion Sensor, TV Mount]-Matte Black W 94.5" D 95.563" H 85.625"	\$71277
	CPRM-MWT MBK, MWT	COVE Room Pod [Includes Power, Lighting, Motion Sensor, TV Mount]-Matte White W 94.5" D 95.563" H 85.625"	\$71277
	CPSS-GRC Gray Combo	COVE Pod Sofa Set [for CPRM]-Gray W 87.25" D 85" H 27.5"	\$2869
	CPTP-MBK MBK, MWT	COVE Meeting Pod [Includes Power, Surface, Lighting, Motion Sensor, High-Back Seats]-Matte Black W 86.625" D 50.5" H 85.813"	\$39146
	CPTP-MWT MBK, MWT	COVE Meeting Pod [Includes Power, Surface, Lighting, Motion Sensor, High-Back Seats]-Matte White W 86.625" D 50.5" H 85.813"	\$39146

IMAGE	CODE	DESCRIPTION	LIST
Classic Pods 	KIT-C1PFP COVEFIN	COVE Classic 1-Person Focus Pod [Includes Lighting & Freestanding Table] W 57" D 33.5" H 83.25"	\$18911
	KIT-C2PMP COVEFIN	COVE Classic 2-Person Meeting Pod [Includes Optional Monitor Mount, Lighting & Table] W 85" D 33.5" H 83.25"	\$19077
	KIT-C4PMP COVEFIN	COVE Classic 4-Person Meeting Pod [Includes Optional Monitor Mount, Lighting & Table] W 85" D 56.75" H 83.25"	\$24602
	KIT-C4POMP COVEFIN	COVE Classic 4-Person Open-Panel Meeting Pod [Includes Lighting & Freestanding Table] W 85" D 56.75" H 83.25"	\$24769

KOLAB LOUNGE SEATING

IMAGE	CODE	DESCRIPTION	LIST
<p>Ottomans</p> 	<p>KBSQ GST, STM</p>	<p>KOLAB Square Ottoman - FAST W 29" D 29" H 18"</p>	<p>\$819</p>
<p>Power</p> 	<p>KPUAC BLK, WHT</p>	<p>Inset Power Unit [1 Power Outlet, USB A+C, 72" Cord]</p>	<p>\$606</p>
<p>Segments</p> 	<p>KBS1 GST, STM</p>	<p>KOLAB Single Segment - FAST W 27.5" D 29" H 32"</p>	<p>\$1036</p>
	<p>KBS2 GST, STM</p>	<p>KOLAB 2-Seat Segment - FAST W 55" D 29" H 32"</p>	<p>\$1614</p>
	<p>KBSC GST, STM</p>	<p>KOLAB Corner Segment - FAST W 29" D 29" H 32"</p>	<p>\$1355</p>

SEATING ACCESSORIES + CONFERENCE CHAIRS

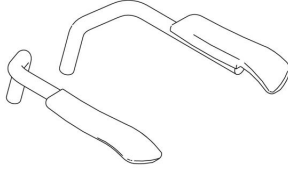
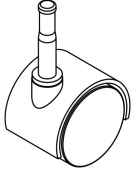
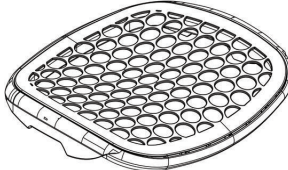
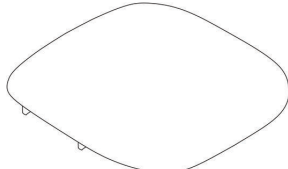
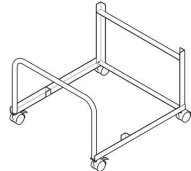


IMAGE	CODE	DESCRIPTION	LIST
	N33AR BLK	Blaze Armrest Kit, Set of 2	\$54
	N33CI2 BLK	Blaze Caster Kit, Set of 4 (V2) W 1.85" D 1.5" H 1.87"	\$31
	N33MS BLK	Blaze Mesh Seat W 18" D 17.25" H 3"	\$158
	N33SC BLK	Blaze Cushion Seat W 18" D 18.25" H 3"	\$158
	N33SC.UPH	Blaze Cushion Seat Reupholstery [Requires 1 Yard] - FX/COM	\$377
	NM33A BLK	Blaze Chair Trolley [Stacks 25 Chairs] W 23.25" D 21.75" H 16"	\$414

IMAGE	CODE	DESCRIPTION	LIST
	N977 BLK	Vogue (Mid-Back) [Conference Chair] W 22" D 26" H 36"-39"	\$975
	N979 BLK	Vogue (High-Back) [Conference Chair] W 22" D 26" H 17"-19.5"	\$994

SEATING NESTING CHAIRS + SIDE CHAIRS



IMAGE	CODE	DESCRIPTION	LIST
	N2000 BLK	Ice [Nesting Chair, Includes Casters and Arms] W 22" D 23" H 31"	\$406
	N2000.UPH	Ice Seat Reupholstery [Requires 0.75 Yards] - FX/COM	\$271

IMAGE	CODE	DESCRIPTION	LIST
	N899 BLK	Kule 2 [Side Chair, Includes Arms] W 23" D 25" H 34"	\$344
	N899.UPH	Kule 2 Seat Reupholstery [Requires 0.75 Yards] - FX/COM	\$271

SEATING STACKING CHAIRS + STOOLS




IMAGE	CODE	DESCRIPTION	LIST
	N33BH BLK, BLU, CTR, WHT	Blaze (Bar Stool) [Armless Stackable Stool] W 23.25" D 25.38" H 45.25"	\$663
	N33PK BLK, BLU, CTR, WHT	Blaze [Armless Stackable Chair, Includes Glides] W 21.25" D 23.25" H 33.5"	\$426
	N899 BLK	Kule 2 [Side Chair, Includes Arms] W 23" D 25" H 34"	\$344
	N899.UPH	Kule 2 Seat Reupholstery [Requires 0.75 Yards] - FX/COM	\$271

IMAGE	CODE	DESCRIPTION	LIST
	DK1 BLK	Drafting Stool Kit [For Task and Conference Chairs] W 18" D 18" H 8"-14"	\$185
	N33BH BLK, BLU, CTR, WHT	Blaze (Bar Stool) [Armless Stackable Stool] W 23.25" D 25.38" H 45.25"	\$663

SEATING TASK CHAIRS





IMAGE	CODE	DESCRIPTION	LIST
	N5000 BLK	Epic [Task Chair] W 25" D 23" H 37"-41"	\$633
	N5000.UPH	Epic Seat Reupholstery [Requires 1 Yard] - FX/COM	\$359
	N6000 MID, FX/COM Uph	Fusion [Task Chair] W 28" D 22" H 36"-40"	\$712
	N6000.UPH	Fusion Seat Reupholstery [Requires 0.75 Yards] - FX/COM	\$359
	N7000 MID, FX/COM Uph	Razor [Task Chair] W 26" D 24" H 39"-42"	\$1118
	N7000.UPH	Razor Seat Reupholstery [Requires 1 Yard] - FX/COM	\$258
	V402.COM COM	Ventus [Task Chair with COM Seat] W 26.38"-27.56" D 24.21"-26.18" H 40.16"-44.88"	\$1274
	V402.FAST VNTFAST	Ventus [Task Chair] W 26.38"-27.56" D 24.21"-26.18" H 40.16"-44.88"	\$1099

IMAGE	CODE	DESCRIPTION	LIST
	V402.FX FX-Bryant Park	Ventus [Task Chair with FX Seat] W 26.38"-27.56" D 24.21"-26.18" H 40.16"-44.88"	\$1411

SURFACES FAST PROGRAM

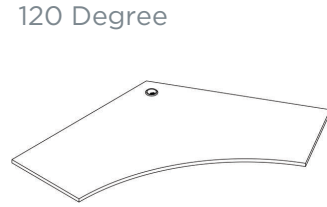
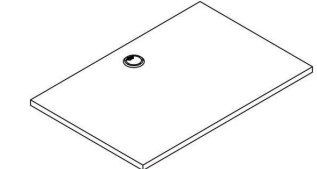
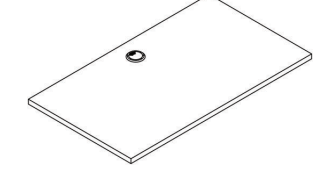
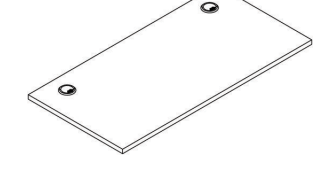
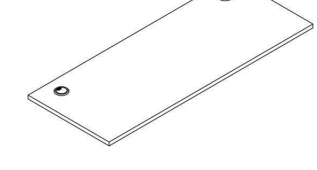
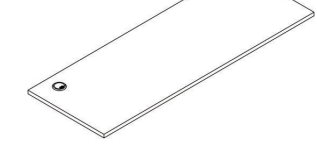
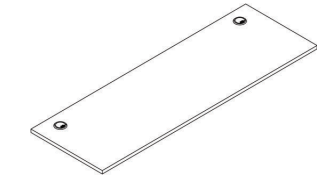
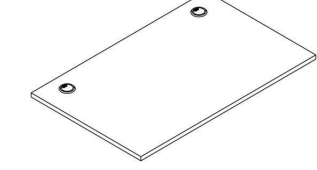
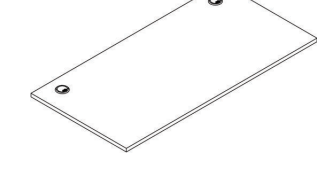
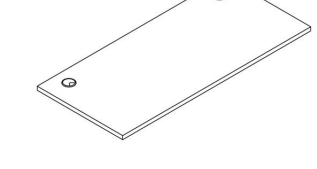
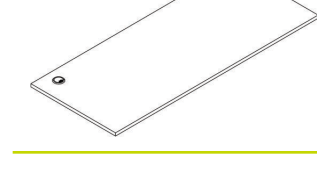
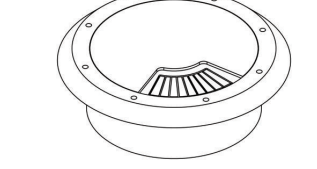
IMAGE	CODE	DESCRIPTION	LIST
 <p>120 Degree</p>	GB120V2 FFIN2	120 Degree Surface (V2) [1" Thick, Includes 1 Pre-Installed Grommet] - FAST W 83" D 44.75" H 1"	\$933
 <p>24" Deep Rectangular</p>	GB2436 FFIN2	24"x36" Cross-Grain Surface [1" Thick, Includes 1 Pre-Installed Grommet] - FAST W 36" D 24" H 1"	\$279
	GB2442 FFIN2	24"x42" Cross-Grain Surface [1" Thick, Includes 1 Pre-Installed Grommet] - FAST W 42" D 24" H 1"	\$293
	GB2448 FFIN2	24"x48" Surface [1" Thick, Includes 2 Pre-Installed Grommets] - FAST W 48" D 24" H 1"	\$336
	GB2460 FFIN2	24"x60" Surface [1" Thick, Includes 2 Pre-Installed Grommets] - FAST W 60" D 24" H 1"	\$416
	GB2466 FFIN2	24"x66" Surface [1" Thick, Includes 2 Pre-Installed Grommets] - FAST W 66" D 24" H 1"	\$457

IMAGE	CODE	DESCRIPTION	LIST
	GB2472 FFIN2	24"x72" Surface [1" Thick, Includes 2 Pre-Installed Grommets] - FAST W 72" D 24" H 1"	\$492
 <p>30" Deep Rectangular</p>	GB3048 FFIN2	30"x48" Surface [1" Thick, Includes 2 Pre-Installed Grommets] - FAST W 48" D 30" H 1"	\$416
	GB3060 FFIN2	30"x60" Surface [1" Thick, Includes 2 Pre-Installed Grommets] - FAST W 60" D 30" H 1"	\$532
	GB3066 FFIN2	30"x66" Surface [1" Thick, Includes 2 Pre-Installed Grommets] - FAST W 66" D 30" H 1"	\$585
	GB3072 FFIN2	30"x72" Surface [1" Thick, Includes 2 Pre-Installed Grommets] - FAST W 72" D 30" H 1"	\$611
 <p>Grommet</p>	BLG60 BLK, SLV, WHT	Grommet [60mm, Additional for Fast Surfaces] W 2.36" D 2.36" H 0.75"	\$17

SURFACES

FAST PROGRAM + FX PROGRAM

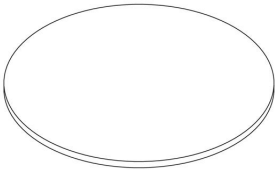
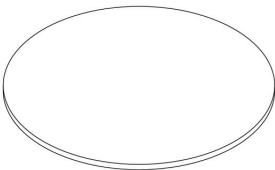
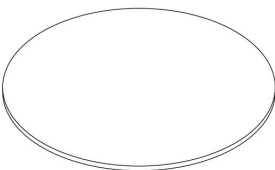
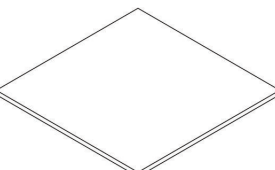
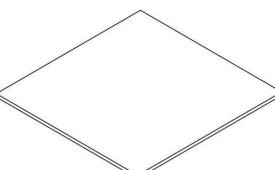
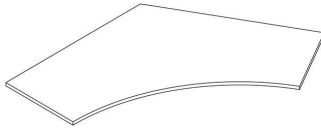

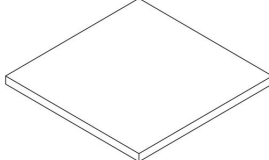
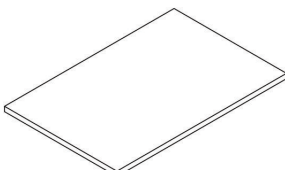
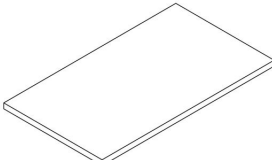
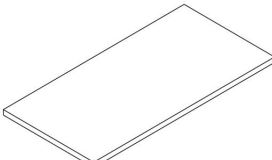
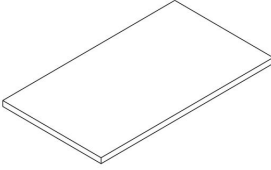
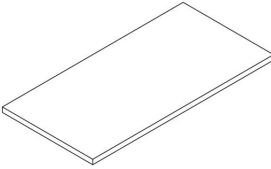
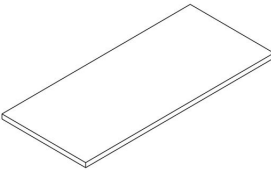
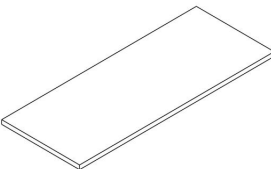
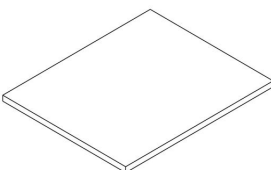
IMAGE	CODE	DESCRIPTION	LIST
Round 	GB360 FFIN2	36" Round Surface [1" Thick] - FAST W 36" D 36" H 1"	\$490
	GB420 FFIN2	42" Round Surface [1" Thick] - FAST W 42" D 42" H 1"	\$493
	GB480 FFIN2	48" Round Surface [1" Thick] - FAST W 48" D 48" H 1"	\$606
Square 	GB3636 FFIN2	36"x36" Surface [1" Thick] - FAST W 36" D 36" H 1"	\$482
	GB4849 FFIN2	49"x48" Surface [1" Thick] - FAST W 48" D 49" H 1"	\$611

IMAGE	CODE	DESCRIPTION	LIST
120 Degree 	WA48120 FX	120 Degree Surface (48" Sides) - FX W 83" D 44.75" H 1.25"	\$1288
	WA60120 FX	120 Degree Surface (60" Sides) - FX W 104" D 50.75" H 1.25"	\$2162
24" Deep Rectangular 	WA2424 FX	24"x24" Surface - FX W 24" D 24" H 1.25"	\$743
	WA2436 FX	24"x36" Surface - FX W 36" D 24" H 1.25"	\$743
	WA2442 FX	24"x42" Surface - FX W 42" D 24" H 1.25"	\$780
	WA2448 FX	24"x48" Surface - FX W 48" D 24" H 1.25"	\$804

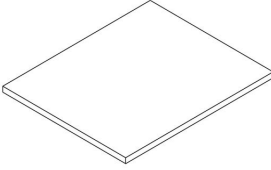
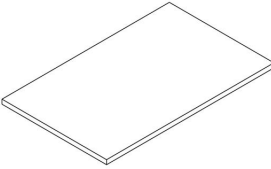
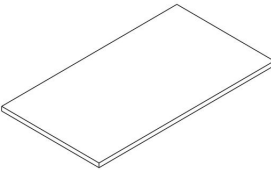
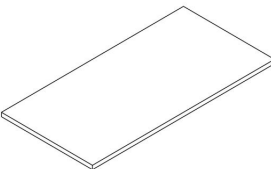
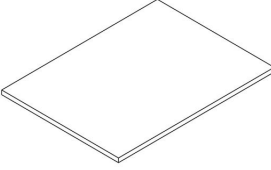
SURFACES FX PROGRAM

IMAGE	CODE	DESCRIPTION	LIST
	WA2454 FX	24"x54" Surface - FX W 54" D 24" H 1.25"	\$898
	WA2460 FX	24"x60" Surface - FX W 60" D 24" H 1.25"	\$898
	WA2466 FX	24"x66" Surface - FX W 66" D 24" H 1.25"	\$997
	WA2472 FX	24"x72" Surface - FX W 72" D 24" H 1.25"	\$997
	WA2484 FX	24"x84" Surface - FX W 84" D 24" H 1.25"	\$1288
	WA2496.2 FX	24"x96" Surface, 2-Piece - FX W 96" D 24" H 1.25"	\$2705
	WA3624 FX	24"x36" Cross-Grain Surface - FX W 36" D 24" H 1.25"	\$743

IMAGE	CODE	DESCRIPTION	LIST
	WA4224 FX	24"x42" Cross-Grain Surface - FX W 42" D 24" H 1.25"	\$780
	WA4824 FX	24"x48" Cross-Grain Surface - FX W 48" D 24" H 1.25"	\$804
	WA5424 FX	24"x54" Cross-Grain Surface - FX W 24" D 54" H 1.25"	\$898
	WA6024 FX	24"x60" Cross-Grain Surface - FX W 60" D 24" H 1.25"	\$898
30" Deep Rectangular	WA3036 FX	30"x36" Surface - FX W 36" D 30" H 1.25"	\$804
	WA3042 FX	30"x42" Surface - FX W 42" D 30" H 1.25"	\$1001

SURFACES FX PROGRAM

IMAGE	CODE	DESCRIPTION	LIST
	WA3048 FX	30"x48" Surface - FX W 48" D 30" H 1.25"	\$1001
	WA3054 FX	30"x54" Surface - FX W 54" D 30" H 1.25"	\$1010
	WA3060 FX	30"x60" Surface - FX W 60" D 30" H 1.25"	\$1010
	WA3066 FX	30"x66" Surface - FX W 66" D 30" H 1.25"	\$1060
	WA3072 FX	30"x72" Surface - FX W 72" D 30" H 1.25"	\$1060
	WA3084 FX	30"x84" Surface - FX W 84" D 30" H 1.25"	\$1288
	WA3096.2 FX	30"x96" Surface, 2-Piece - FX W 96" D 30" H 1.25"	\$2705

IMAGE	CODE	DESCRIPTION	LIST
	WA3630 FX	30"x36" Cross-Grain Surface - FX W 36" D 30" H 1.25"	\$804
	WA4830 FX	30"x48" Cross-Grain Surface - FX W 48" D 30" H 1.25"	\$1001
	WA5430 FX	30"x54" Cross-Grain Surface - FX W 54" D 30" H 1.25"	\$1010
	WA6030 FX	30"x60" Cross-Grain Surface - FX W 60" D 30" H 1.25"	\$1010
36" Deep Rectangular	WA3648 FX	36"x48" Surface - FX W 48" D 36" H 1.25"	\$1060
	WA3654 FX	36"x54" Surface - FX W 54" D 36" H 1.25"	\$1060

SURFACES FX PROGRAM

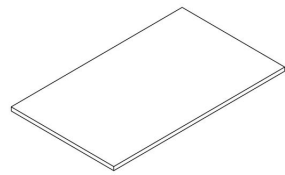
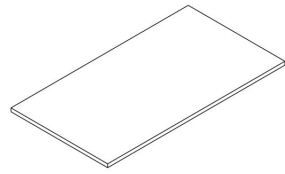
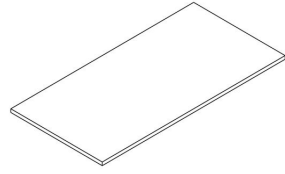
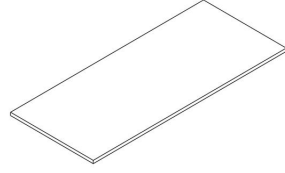
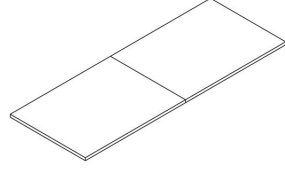
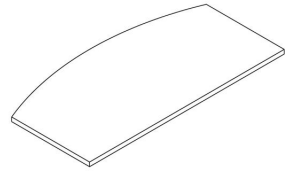
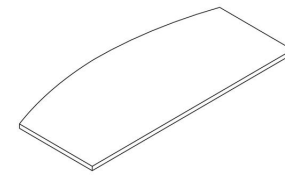
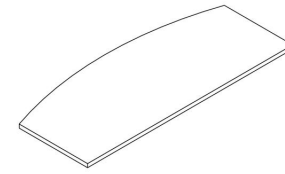
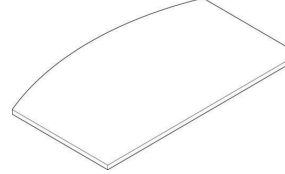
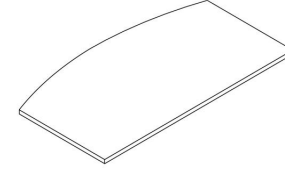
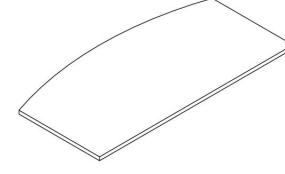
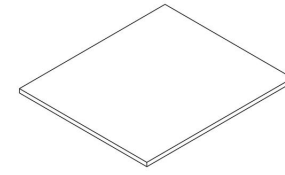
IMAGE	CODE	DESCRIPTION	LIST
	WA3660 FX	36"x60" Surface - FX W 60" D 36" H 1.25"	\$1060
	WA3666 FX	36"x66" Surface - FX W 66" D 36" H 1.25"	\$1060
	WA3672 FX	36"x72" Surface - FX W 72" D 36" H 1.25"	\$1288
	WA3684 FX	36"x84" Surface - FX W 84" D 36" H 1.25"	\$1483
	WA3696.2 FX	36"x96" Surface, 2-Piece - FX W 96" D 36" H 1.25"	\$2705
Bow-Front 	WA3060BOW FX	30"x60" Bow-Front Surface - FX W 60" D 30" H 1.25"	\$1288

IMAGE	CODE	DESCRIPTION	LIST
	WA3066BOW FX	30"x66" Bow-Front Surface - FX W 66" D 30" H 1.25"	\$1288
	WA3072BOW FX	30"x72" Bow-Front Surface - FX W 72" D 30" H 1.25"	\$1288
	WA3660BOW FX	36"x60" Bow-Front Surface - FX W 60" D 36" H 1.25"	\$1288
	WA3666BOW FX	36"x66" Bow-Front Surface - FX W 66" D 36" H 1.25"	\$1288
	WA3672BOW FX	36"x72" Bow-Front Surface - FX W 72" D 36" H 1.25"	\$1288
Conference 42" Deep 	WA4248 FX	42"x48" Surface - FX W 48" D 42" H 1.25"	\$1319

SURFACES FX PROGRAM

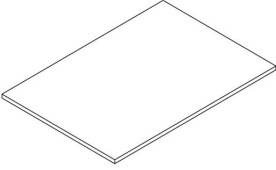
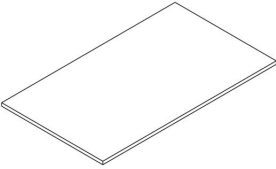
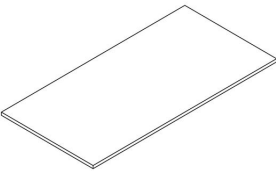
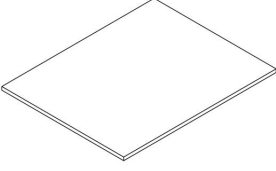
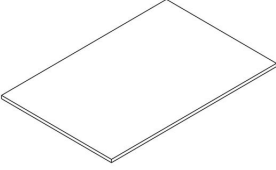
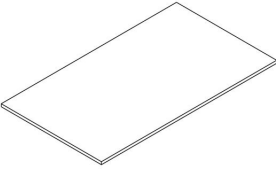
IMAGE	CODE	DESCRIPTION	LIST
	WA4260 FX	42"x60" Surface - FX W 60" D 42" H 1.25"	\$1319
	WA4272 FX	42"x72" Surface - FX W 72" D 42" H 1.25"	\$1319
	WA4284 FX	42"x84" Surface - FX W 84" D 42" H 1.25"	\$1483
Conference 48" Deep 	WA4860 FX	48"x60" Conference Table Surface - FX W 60" D 48" H 1.25"	\$1319
	WA4872 FX	48"x72" Conference Table Surface - FX W 72" D 48" H 1.25"	\$1319
	WA4884 FX	48"x84" Conference Table Surface - FX W 84" D 48" H 1.25"	\$1483

IMAGE	CODE	DESCRIPTION	LIST
Conference 49" Deep 	WA49108.CONF FX	49"x108" Conference Table Surface, 2-Piece - FX W 108" D 49" H 1.25"	\$2705
	WA49120.CONF FX	49"x120" Conference Table Surface, 2-Piece - FX W 120" D 49" H 1.25"	\$2705
	WA49132.CONF FX	49"x132" Conference Table Surface, 2-Piece - FX W 132" D 49" H 1.25"	\$2808
	WA49144.CONF FX	49"x144" Conference Table Surface, 2-Piece - FX W 144" D 49" H 1.25"	\$2808
	WA49156.CONF FX	49"x156" Conference Table Surface, 2-Piece - FX W 156" D 49" H 1.25"	\$2910
	WA49168.CONF FX	49"x168" Conference Table Surface, 2-Piece - FX W 168" D 49" H 1.25"	\$2910

SURFACES FX PROGRAM

IMAGE	CODE	DESCRIPTION	LIST
	WA49180.CONF.3 FX	49"x180" Conference Table Surface, 3-Piece - FX W 180" D 49" H 1.25"	\$5357
	WA49192.CONF.3 FX	49"x192" Conference Table Surface, 3-Piece - FX W 192" D 49" H 1.25"	\$5357
	WA49204.CONF.3 FX	49"x204" Conference Table Surface, 3-Piece - FX W 204" D 49" H 1.25"	\$5357
	WA49216.CONF.3 FX	49"x216" Conference Table Surface, 3-Piece - FX W 216" D 49" H 1.25"	\$5357
	WA49228.CONF.3 FX	49"x228" Conference Table Surface, 3-Piece - FX W 228" D 49" H 1.25"	\$5357
	WA49240.CONF.3 FX	49"x240" Conference Table Surface, 3-Piece - FX W 240" D 49" H 1.25"	\$5357
	WA49264.CONF.4 FX	49"x264" Conference Table Surface, 4-Piece - FX W 264" D 49" H 1.25"	\$8943

IMAGE	CODE	DESCRIPTION	LIST
	WA49288.CONF.4 FX	49"x288" Conference Table Surface, 4-Piece - FX W 288" D 49" H 1.25"	\$9072
	WA4948 FX	49"x48" Surface - FX W 48" D 49" H 1.25"	\$1319
	WA4960 FX	49"x60" Conference Table Surface - FX W 60" D 49" H 1.25"	\$1319
	WA4972 FX	49"x72" Conference Table Surface - FX W 72" D 49" H 1.25"	\$1319
	WA4984 FX	49"x84" Conference Table Surface - FX W 84" D 49" H 1.25"	\$1483
	WA4996.CONF FX	49"x96" Conference Table Surface, 2-Piece - FX W 96" D 49" H 1.25"	\$2705
	WA4996.CONF.MB WAMB	49"x96" Conference Table Marker-Board Surface, 2-Piece - FX W 96" D 49" H 1.25"	\$2918

SURFACES FX PROGRAM

IMAGE	CODE	DESCRIPTION	LIST
 <p>Conference 61" Deep</p>	WA61108.CONF FX	61"x108" Conference Table Surface, 2-Piece - FX W 108" D 61" H 1.25"	\$2705
	WA61120.CONF FX	61"x120" Conference Table Surface, 2-Piece - FX W 120" D 61" H 1.25"	\$2705
	WA61132.CONF FX	61"x132" Conference Table Surface, 2-Piece - FX W 132" D 61" H 1.25"	\$2808
	WA61144.CONF FX	61"x144" Conference Table Surface, 2-Piece - FX W 144" D 61" H 1.25"	\$2808
	WA61156.CONF FX	61"x156" Conference Table Surface, 2-Piece - FX W 156" D 61" H 1.25"	\$2910
	WA61168.CONF FX	61"x168" Conference Table Surface, 2-Piece - FX W 168" D 61" H 1.25"	\$2910

IMAGE	CODE	DESCRIPTION	LIST
	WA61180.CONF.3 FX	61"x180" Conference Table Surface, 3-Piece - FX W 180" D 61" H 1.25"	\$6012
	WA61192.CONF.3 FX	61"x192" Conference Table Surface, 3-Piece - FX W 192" D 61" H 1.25"	\$6012
	WA61204.CONF.3 FX	61"x204" Conference Table Surface, 3-Piece - FX W 204" D 61" H 1.25"	\$6116
	WA61216.CONF.3 FX	61"x216" Conference Table Surface, 3-Piece - FX W 216" D 61" H 1.25"	\$6116
	WA61228.CONF.3 FX	61"x228" Conference Table Surface, 3-Piece - FX W 228" D 61" H 1.25"	\$6218
	WA61240.CONF.3 FX	61"x240" Conference Table Surface, 3-Piece - FX W 240" D 61" H 1.25"	\$6218
	WA61264.CONF.4 FX	61"x264" Conference Table Surface, 4-Piece - FX W 264" D 61" H 1.25"	\$10998

SURFACES FX PROGRAM

IMAGE	CODE	DESCRIPTION	LIST
	WA61288.CONF.4 FX	61"x288" Conference Table Surface, 4-Piece - FX W 288" D 61" H 1.25"	\$11205
	WA6148 FX	61"x48" Surface - FX W 48" D 61" H 1.25"	\$1771
	WA6160 FX	61"x60" Surface - FX W 60" D 61" H 1.25"	\$1771
	WA6172 FX	61"x72" Conference Table Surface - FX W 72" D 61" H 1.25"	\$1931
	WA6184 FX	61"x84" Conference Table Surface - FX W 84" D 61" H 1.25"	\$1931
	WA6196.CONF FX	61"x96" Conference Table Surface, 2-Piece - FX W 96" D 61" H 1.25"	\$2705
	WA7230D.L FX	72"x30" D-End Surface (D-End on Left) - FX W 72" D 30" H 1.25"	\$1288

IMAGE	CODE	DESCRIPTION	LIST
	WA7230D.R FX	72"x30" D-End Surface (D-End on Right) - FX W 72" D 30" H 1.25"	\$1288
	WA7236D.L FX	72"x36" D-End Surface (D-End on Left) - FX W 72" D 36" H 1.25"	\$1288
	WA7236D.R FX	72"x36" D-End Surface (D-End on Right) - FX W 72" D 36" H 1.25"	\$1288
	WA8430D.L FX	84"x30" D-End Surface (D-End on Left) - FX W 84" D 30" H 1.25"	\$1288
	WA8430D.R FX	84"x30" D-End Surface (D-End on Right) - FX W 84" D 30" H 1.25"	\$1288
	WA8436D.L FX	84"x36" D-End Surface (D-End on Left) - FX W 84" D 36" H 1.25"	\$1288
	WA8436D.R FX	84"x36" D-End Surface (D-End on Right) - FX W 84" D 36" H 1.25"	\$1288

SURFACES FX PROGRAM

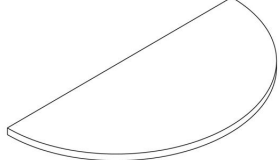
IMAGE	CODE	DESCRIPTION	LIST
Grommets 	BLW80 BLK, SLV, WHT	Grommet [80mm, Specify "FL" for Front-Left, "FR" for Front-Right, "FC" for Front-Center] W 3.15" D 3.15" H 0.75"	\$27
	CNWG SLV	Wire Management Grommet [For Conference Surfaces, Cutout Size 4"x8"] W 8.31" D 4.42" H 0.13"	\$91
Half-Round 	WAHR.A FX	24.813"x49.625" Half-Round Surface - FX W 49.625" D 24.813" H 1.25"	\$1010
	WAHR.B FX	30.813"x61.625" Half-Round Surface - FX W 61.625" D 30.813" H 1.25"	\$1010
L-Shape 24" Deep 	WA4824L4824.L FX	48"x48" L-Shape Surface (24" Deep, Return on Left) - FX W 48" D 48" H 1.25"	\$1288
	WA4824L4824.R FX	48"x48" L-Shape Surface (24" Deep, Return on Right) - FX W 48" D 48" H 1.25"	\$1288

IMAGE	CODE	DESCRIPTION	LIST
	WA4824L6024.L FX	48"x60" L-Shape Surface (24" Deep, Return on Left) - FX W 48" D 60" H 1.25"	\$1288
	WA4824L6024.R FX	48"x60" L-Shape Surface (24" Deep, Return on Right) - FX W 48" D 60" H 1.25"	\$1288
	WA4824L7224.L FX	48"x72" L-Shape Surface (24" Deep, Return on Left) - FX W 48" D 72" H 1.25"	\$1288
	WA4824L7224.R FX	48"x72" L-Shape Surface (24" Deep, Return on Right) - FX W 48" D 72" H 1.25"	\$1288
	WA6024L4824.L FX	60"x48" L-Shape Surface (24" Deep, Return on Left) - FX W 60" D 48" H 1.25"	\$1288
	WA6024L4824.R FX	60"x48" L-Shape Surface (24" Deep, Return on Right) - FX W 60" D 48" H 1.25"	\$1288
	WA6024L6024.L FX	60"x60" L-Shape Surface (24" Deep, Return on Left) - FX W 60" D 60" H 1.25"	\$1288

SURFACES FX PROGRAM

IMAGE	CODE	DESCRIPTION	LIST
	WA6024L6024.R FX	60"x60" L-Shape Surface (24" Deep, Return on Right) - FX W 60" D 60" H 1.25"	\$1288
	WA6024L7224.L FX	60"x72" L-Shape Surface (24" Deep, Return on Left) - FX W 60" D 72" H 1.25"	\$1771
	WA6024L7224.R FX	60"x72" L-Shape Surface (24" Deep, Return on Right) - FX W 60" D 72" H 1.25"	\$1771
	WA7224L4824.L FX	72"x48" L-Shape Surface (24" Deep, Return on Left) - FX W 72" D 48" H 1.25"	\$1288
	WA7224L4824.R FX	72"x48" L-Shape Surface (24" Deep, Return on Right) - FX W 72" D 48" H 1.25"	\$1288
	WA7224L6024.L FX	72"x60" L-Shape Surface (24" Deep, Return on Left) - FX W 72" D 60" H 1.25"	\$1771
	WA7224L6024.R FX	72"x60" L-Shape Surface (24" Deep, Return on Right) - FX W 72" D 60" H 1.25"	\$1771

IMAGE	CODE	DESCRIPTION	LIST
L-Shape 30" Deep 	WA7230L4830.L FX	72"x48" L-Shape Surface (30" Deep, Return on Left) - FX W 72" D 48" H 1.25"	\$1288
	WA7230L4830.R FX	72"x48" L-Shape Surface (30" Deep, Return on Right) - FX W 72" D 48" H 1.25"	\$1288
	WA7230L6030.L FX	72"x60" L-Shape Surface (30" Deep, Return on Left) - FX W 72" D 60" H 1.25"	\$1771
	WA7230L6030.R FX	72"x60" L-Shape Surface (30" Deep, Return on Right) - FX W 72" D 60" H 1.25"	\$1771
L-Shape 30"/24" Deep 	WA7230L4824.L FX	72"x48" L-Shape Surface (30"/24" Deep, Return on Left) - FX W 72" D 48" H 1.25"	\$1288
	WA7230L4824.R FX	72"x48" L-Shape Surface (30"/24" Deep, Return on Right) - FX W 72" D 48" H 1.25"	\$1288

SURFACES FX PROGRAM

IMAGE	CODE	DESCRIPTION	LIST
	WA7230L6024.L FX	72"x60" L-Shape Surface (30"/24" Deep, Return on Left) - FX W 72" D 60" H 1.25"	\$1771
	WA7230L6024.R FX	72"x60" L-Shape Surface (30"/24" Deep, Return on Right) - FX W 72" D 60" H 1.25"	\$1771
P-Shape	WA7236P.L FX	72"x36" P-Shape Surface (P-Shape on Left) - FX W 72" D 36" H 1.25"	\$1288
	WA7236P.R FX	72"x36" P-Shape Surface (P-Shape on Right) - FX W 72" D 36" H 1.25"	\$1288
	WA8436P.L FX	84"x36" P-Shape Surface (P-Shape on Left) - FX W 84" D 36" H 1.25"	\$1288
	WA8436P.R FX	84"x36" P-Shape Surface (P-Shape on Right) - FX W 84" D 36" H 1.25"	\$1288

IMAGE	CODE	DESCRIPTION	LIST
Round	WA30R FX	30" Round Surface - FX W 30" D 30" H 1.25"	\$780
	WA36R FX	36" Round Surface - FX W 36" D 36" H 1.25"	\$933
	WA42R FX	42" Round Surface - FX W 42" D 42" H 1.25"	\$1036
	WA48R FX	48" Round Surface - FX W 48" D 48" H 1.25"	\$1036
	WA60R FX	60" Round Surface - FX W 60" D 60" H 1.25"	\$1066
Square	WA3636 FX	36"x36" Surface - FX W 36" D 36" H 1.25"	\$977

SURFACES FX PROGRAM

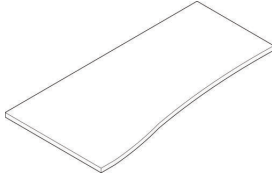
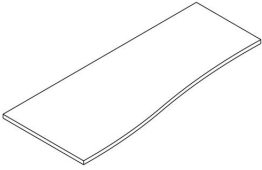
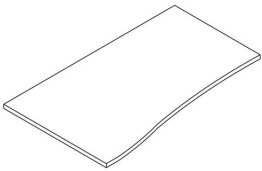
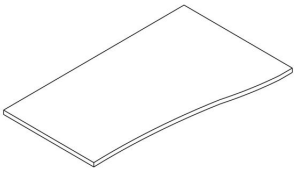
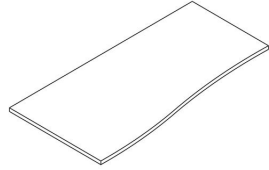
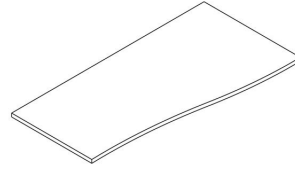
IMAGE	CODE	DESCRIPTION	LIST
Wave 24"-30" Deep 	WA24.3060WAVE.L FX	24"-30"x60" Wave Surface (30" Deep on Left) - FX W 60" D 24"-30" H 1.25"	\$1288
	WA24.3060WAVE.R FX	24"-30"x60" Wave Surface (30" Deep on Right) - FX W 60" D 24"-30" H 1.25"	\$1288
	WA24.3072WAVE.L FX	24"-30"x72" Wave Surface (30" Deep on Left) - FX W 72" D 24"-30" H 1.25"	\$1288
	WA24.3072WAVE.R FX	24"-30"x72" Wave Surface (30" Deep on Right) - FX W 72" D 24"-30" H 1.25"	\$1288
Wave 30"-36" Deep 	WA30.3660WAVE.L FX	30"-36"x60" Wave Surface (36" Deep on Left) - FX W 60" D 30"-36" H 1.25"	\$1288
	WA30.3660WAVE.R FX	30"-36"x60" Wave Surface (36" Deep on Right) - FX W 60" D 30"-36" H 1.25"	\$1288

IMAGE	CODE	DESCRIPTION	LIST
	WA30.3672WAVE.L FX	30"-36"x72" Wave Surface (36" Deep on Left) - FX W 72" D 30"-36" H 1.25"	\$1288
	WA30.3672WAVE.R FX	30"-36"x72" Wave Surface (36" Deep on Right) - FX W 72" D 30"-36" H 1.25"	\$1288

TABLES BASES + LAPTOP TABLE

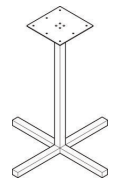
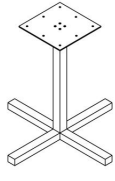
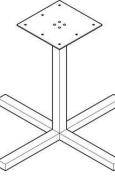
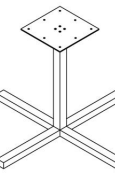
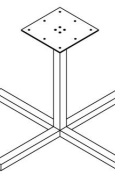
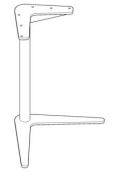
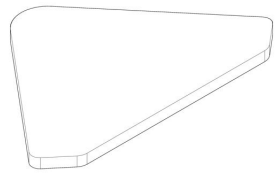
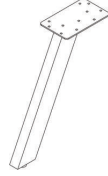



IMAGE	CODE	DESCRIPTION	LIST
<p>Standing-Height X-Bases</p> 	<p>XTBH32 BLK, SLV, WHT</p>	<p>32" Standing-Height X-Base [38.39" High, For 36"-41" Surfaces] - FAST W 32" D 32" H 38.39"</p>	\$582
<p>X-Bases</p> 	<p>XT28 BLK, SLV, WHT</p>	<p>28" X-Base [27.36" High, For 30"-35" Surfaces] - FAST W 28" D 32" H 27.36"</p>	\$395
	<p>XT32 BLK, SLV, WHT</p>	<p>32" X-Base [27.36" High, For 36"-41" Surfaces] - FAST W 32" D 32" H 27.36"</p>	\$506
	<p>XT36 BLK, SLV, WHT</p>	<p>36" X-Base [27.36" High, For 42"-45" Surfaces] - FAST W 36" D 36" H 27.36"</p>	\$553
	<p>XT38 BLK, SLV, WHT</p>	<p>38" X-Base [27.36" High, For 46"-50" Surfaces] - FAST W 38" D 38" H 27.75"</p>	\$555

IMAGE	CODE	DESCRIPTION	LIST
	<p>LPT BLK, SLV, WHT</p>	<p>Laptop Table Base [26.5" High] W 22.25" D 13" H 26.5"</p>	\$366
	<p>LPT.TOP ELM1, OAK1, WHT, MPL</p>	<p>Laptop Table Surface [1" Thick] - FAST W 24.75" D 16" H 1"</p>	\$191

TABLES LEGS

IMAGE	CODE	DESCRIPTION	LIST
<p>Legs</p> 	<p>APL BLK, SLV, WHT</p>	<p>Angled Post Leg [27.5" High] W 7.87" D 12.6" H 27.36"</p>	<p>\$152</p>
	<p>BMPL BLK, SLV, WHT</p>	<p>Mobile Post Leg Kit, Set of 4 [Includes Locking Casters] W 1.98" D 1.98" H 27.36"</p>	<p>\$328</p>
	<p>BSPL BLK, SLV, WHT</p>	<p>Stationary Post Leg W 1.98" D 1.98" H 27.36"</p>	<p>\$62</p>
<p>Standing-Height Legs</p> 	<p>APLSH BLK, SLV, WHT</p>	<p>Angled Standing-Height Post Leg [38.25" High] W 7.87" D 16.81" H 38.39"</p>	<p>\$216</p>

PANELS BRACKETS + END PANELS

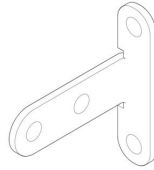
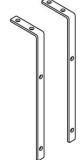
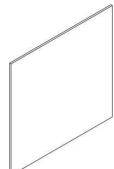
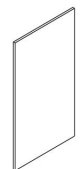
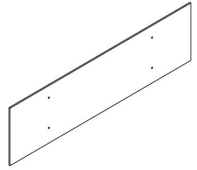
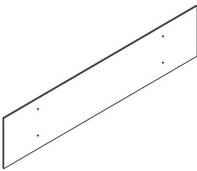
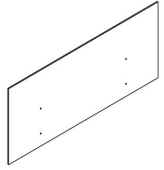
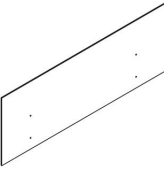
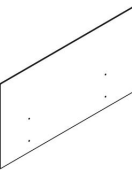
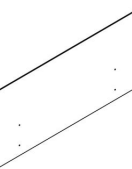
IMAGE	CODE	DESCRIPTION	LIST
End Panel Brackets 	LEPBL1 BLK, SLV, WHT	End Panel T-Bracket [Includes Laminate-to-Metal Hardware] W 2.75" D 0.62" H 2.375"	\$37
	LLTB BLK, SLV, WHT	Laminate-to-Laminate T-Bracket [Includes Laminate-to-Laminate Hardware] W 2.75" D 0.62" H 2.375"	\$37
Modesty Panel Brackets 	BMPBFB BLK, SLV, WHT	3.5"x13.75" Modesty Panel L-Bracket [Includes Hardware] W 3.56" D 0.81" H 13.75"	\$18
	KIT-AMPB4 BLK, SLV, WHT	Modesty Panel L-Bracket, Set of 2 [For Acrylic Modesty Panels] W 0.81" D 3.56" H 13.75"	\$70

IMAGE	CODE	DESCRIPTION	LIST
Laminate Divider-Height 	GBEPSS50 FFIN2	50" Laminate Divider-Height End Panel [48" High, 0.75" Thick] - FAST W 50" D 0.75" H 48"	\$687
	GBEPSS62 FFIN2	62" Laminate Divider-Height End Panel [48" High, 0.75" Thick] - FAST W 62" D 0.75" H 48"	\$725
Laminate Divider-Height (FX) 	WABEPDH.A FX	26" Laminate Divider-Height End Panel [48" High, 0.75" Thick] - FX W 26" D 0.75" H 48"	\$1753
	WABEPDH.B FX	32" Laminate Divider-Height End Panel [48" High, 0.75" Thick] - FX W 32" D 0.75" H 48"	\$1753
	WABEPDH.C FX	50" Laminate Divider-Height End Panel [48" High, 0.75" Thick] - FX W 50" D 0.75" H 48"	\$1753
	WABEPDH.D FX	62" Laminate Divider-Height End Panel [48" High, 0.75" Thick] - FX W 62" D 0.75" H 48"	\$1753

PANELS END PANELS + MODESTY PANELS

IMAGE	CODE	DESCRIPTION	LIST
Laminate Surface-Height 	GBEPLH50 FFIN2	50" Laminate Surface-Height End Panel [28" High, 0.75" Thick] - FAST W 50" D 0.75" H 28"	\$611
	GBEPLH62 FFIN2	62" Laminate Surface-Height End Panel [28" High, 0.75" Thick] - FAST W 62" D 0.75" H 28"	\$628
Laminate Surface-Height (FX) 	WABEPSH.A FX	26" Laminate Surface-Height End Panel [28" High, 0.75" Thick] - FX W 26" D 0.75" H 28"	\$1483
	WABEPSH.B FX	32" Laminate Surface-Height End Panel [28" High, 0.75" Thick] - FX W 32" D 0.75" H 28"	\$1483
	WABEPSH.C FX	50" Laminate Surface-Height End Panel [28" High, 0.75" Thick] - FX W 50" D 0.75" H 28"	\$1483
	WABEPSH.D FX	62" Laminate Surface-Height End Panel [28" High, 0.75" Thick] - FX W 62" D 0.75" H 28"	\$1483

IMAGE	CODE	DESCRIPTION	LIST
Acrylic (FX) 	AMP55.FX CLR, FRS	55" Acrylic Modesty Panel [15" High, Beveled Edges, For 60" Surfaces] - Frosted Acrylic W 55" D 0.25"-0.63" H 15"	\$1570
	AMP67.FX CLR, FRS	67" Acrylic Modesty Panel [15" High, Beveled Edges, For 72" Surfaces] - Frosted Acrylic W 67" D 0.25"-0.63" H 15"	\$1638
Acrylic High/Low (FX) 	ADMP2455.FX CLR, FRS	55" Acrylic Divider/Modesty Panel [24" High, 16.5" Below/6" Above, Beveled Edge, For 60" Surfaces] - Frosted Acrylic W 55" D 0.25"-0.63" H 24"	\$2036
	ADMP2467.FX CLR, FRS	67" Acrylic Divider/Modesty Panel [24" High, 16.5" Below/6" Above, Beveled Edge, For 72" Surfaces] - Frosted Acrylic W 67" D 0.25"-0.63" H 24"	\$2064
	ADMP3055.FX CLR, FRS	55" Acrylic Divider/Modesty Panel [30" High, 16.5" Below/12" Above, Beveled Edge, For 60" Surfaces] - Frosted Acrylic W 55" D 0.25"-0.63" H 30"	\$3876
	ADMP3067.FX CLR, FRS	67" Acrylic Divider/Modesty Panel [30" High, 16.5" Below/12" Above, Beveled Edge, For 72" Surfaces] - Frosted Acrylic W 67" D 0.25"-0.63" H 30"	\$3876

PANELS MODESTY PANELS

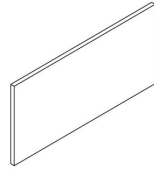
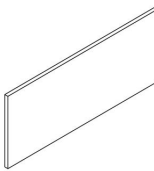
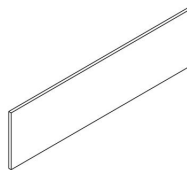
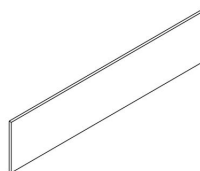
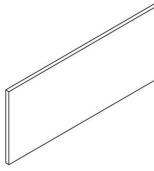
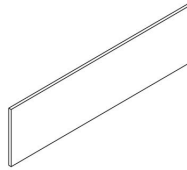
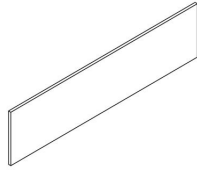
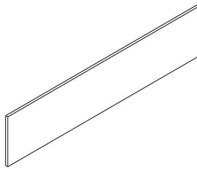
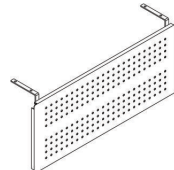
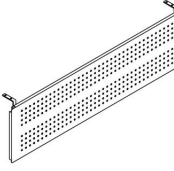
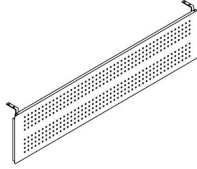
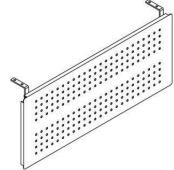
IMAGE	CODE	DESCRIPTION	LIST
Laminate 	GLMP31 FFIN2	31" Laminate Modesty Panel [15" High, 0.75" Thick, For 36" Surfaces] - FAST W 31" D 0.75" H 15"	\$170
	GLMP37V2 FFIN2	37" Laminate Modesty Panel (V2) [15" High, 0.75" Thick, For 42" & 48" Surfaces] - FAST W 37" D 0.75" H 15"	\$176
	GLMP55V2 FFIN2	55" Laminate Modesty Panel (V2) [15" High, 0.75" Thick, For 60" Surfaces] - FAST W 55" D 0.75" H 15"	\$234
	GLMP66V2 FFIN2	66" Laminate Modesty Panel (V2) [15" High, 0.75" Thick, For 72" Surfaces] - FAST W 66" D 0.75" H 15"	\$275
Laminate (FX) 	WA.BMP36 FX	36" Laminate Modesty Panel [15" High, 0.75" Thick, For 48" Surfaces] - FX W 36" D 0.75" H 15"	\$1753
	WA.BMP55 FX	55" Laminate Modesty Panel [15" High, 0.75" Thick, For 60" Surfaces] - FX W 55" D 0.75" H 15"	\$1753

IMAGE	CODE	DESCRIPTION	LIST
	WA.BMP61 FX	61" Laminate Modesty Panel [15" High, 0.75" Thick, For 66" Surfaces] - FX W 61" D 0.75" H 15"	\$1753
	WA.BMP67 FX	67" Laminate Modesty Panel [15" High, 0.75" Thick, For 72" Surfaces] - FX W 67" D 0.75" H 15"	\$1753
Steel 	BMP36 BLK, RAW, SLV, WHT	BLADE 36" Steel Modesty Panel [15" High, Includes Brackets, For 48" Surfaces] W 36" D 0.62" H 15"	\$263
	BMP55V2 BLK, RAW, SLV, WHT	55" Steel Modesty Panel (V2) [15" High, Includes Brackets, For 60" & 66" Surfaces] W 55" D 0.62" H 15"	\$277
	BMP67V2 BLK, RAW, SLV, WHT	67" Steel Modesty Panel (V2) [15" High, Includes Brackets, For 72" Surfaces] W 67" D 0.62" H 15"	\$313
	KIT-BHAMP36 BLK, RAW, SLV, WHT	BOOST 36" Steel Modesty Panel [15" High, Includes Brackets, For 48" Surfaces] W 36" D 0.62" H 15"	\$299

DIVIDERS ACRYLIC (CLEAR)

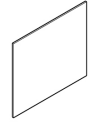
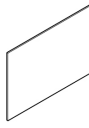




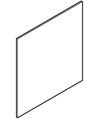
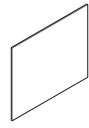
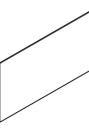



IMAGE	CODE	DESCRIPTION	LIST
<p>20" High (FX)</p>  <p>ADD 2 BSB9 BRACKETS</p>	AC2023.CLR	<p>23" Acrylic Divider [20" High, Square Corners, Beveled Edges] - Clear Acrylic</p> <p>W 23" D 0.25"-0.63" H 20"</p>	\$284
 <p>ADD 2 BSB9 BRACKETS</p>	AC2029.CLR	<p>29" Acrylic Divider [20" High, Square Corners, Beveled Edges] - Clear Acrylic</p> <p>W 29" D 0.25"-0.63" H 20"</p>	\$382
 <p>ADD 3 BSB9 BRACKETS</p>	AC2047.CLR	<p>47" Acrylic Divider [20" High, Square Corners, Beveled Edges] - Clear Acrylic</p> <p>W 47" D 0.25"-0.63" H 20"</p>	\$510
 <p>ADD 3 BSB9 BRACKETS</p>	AC2059.CLR	<p>59" Acrylic Divider [20" High, Square Corners, Beveled Edges] - Clear Acrylic</p> <p>W 59" D 0.25"-0.63" H 20"</p>	\$1086
 <p>ADD 3 BSB9 BRACKETS</p>	AC2065.CLR	<p>65" Acrylic Divider [20" High, Square Corners, Beveled Edges] - Clear Acrylic</p> <p>W 65" D 0.25"-0.63" H 20"</p>	\$1126
 <p>ADD 3 BSB9 BRACKETS</p>	AC2071.CLR	<p>71" Acrylic Divider [20" High, Square Corners, Beveled Edges] - Clear Acrylic</p> <p>W 71" D 0.25"-0.63" H 20"</p>	\$1165

IMAGE	CODE	DESCRIPTION	LIST
<p>24" High (FX)</p>  <p>ADD 2 BSB9 BRACKETS</p>	AC2423.CLR	<p>23" Acrylic Divider [24" High, Square Corners, Beveled Edges] - Clear Acrylic</p> <p>W 23" D 0.25"-0.63" H 24"</p>	\$284
 <p>ADD 2 BSB9 BRACKETS</p>	AC2429.CLR	<p>29" Acrylic Divider [24" High, Square Corners, Beveled Edges] - Clear Acrylic</p> <p>W 29" D 0.25"-0.63" H 24"</p>	\$382
 <p>ADD 3 BSB9 BRACKETS</p>	AC2447.CLR	<p>47" Acrylic Divider [24" High, Square Corners, Beveled Edges] - Clear Acrylic</p> <p>W 47" D 0.25"-0.63" H 24"</p>	\$529
 <p>ADD 3 BSB9 BRACKETS</p>	AC2459.CLR	<p>59" Acrylic Divider [24" High, Square Corners, Beveled Edges] - Clear Acrylic</p> <p>W 59" D 0.25"-0.63" H 24"</p>	\$1106
 <p>ADD 3 BSB9 BRACKETS</p>	AC2465.CLR	<p>65" Acrylic Divider [24" High, Square Corners, Beveled Edges] - Clear Acrylic</p> <p>W 65" D 0.25"-0.63" H 24"</p>	\$1155
 <p>ADD 3 BSB9 BRACKETS</p>	AC2471.CLR	<p>71" Acrylic Divider [24" High, Square Corners, Beveled Edges] - Clear Acrylic</p> <p>W 71" D 0.25"-0.63" H 24"</p>	\$1155

DIVIDERS ACRYLIC (FROSTED)

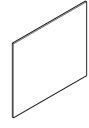
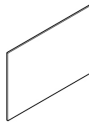




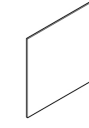
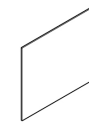
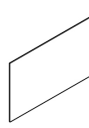
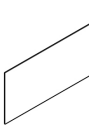
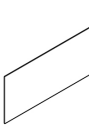
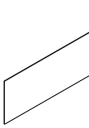
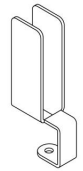
IMAGE	CODE	DESCRIPTION	LIST
<p>20" High (FX)</p>  <p>ADD 2 BSB9 BRACKETS</p>	AC2023.FRS	<p>23" Acrylic Divider [20" High, Square Corners, Beveled Edges] - Frosted Acrylic</p> <p>W 23" D 0.25"-0.63" H 20"</p>	\$515
 <p>ADD 2 BSB9 BRACKETS</p>	AC2029.FRS	<p>29" Acrylic Divider [20" High, Square Corners, Beveled Edges] - Frosted Acrylic</p> <p>W 29" D 0.25"-0.63" H 20"</p>	\$670
 <p>ADD 3 BSB9 BRACKETS</p>	AC2047.FRS	<p>47" Acrylic Divider [20" High, Square Corners, Beveled Edges] - Frosted Acrylic</p> <p>W 47" D 0.25"-0.63" H 20"</p>	\$981
 <p>ADD 3 BSB9 BRACKETS</p>	AC2059.FRS	<p>59" Acrylic Divider [20" High, Square Corners, Beveled Edges] - Frosted Acrylic</p> <p>W 59" D 0.25"-0.63" H 20"</p>	\$1963
 <p>ADD 3 BSB9 BRACKETS</p>	AC2065.FRS	<p>65" Acrylic Divider [20" High, Square Corners, Beveled Edges] - Frosted Acrylic</p> <p>W 65" D 0.25"-0.63" H 20"</p>	\$1963
 <p>ADD 3 BSB9 BRACKETS</p>	AC2071.FRS	<p>71" Acrylic Divider [20" High, Square Corners, Beveled Edges] - Frosted Acrylic</p> <p>W 71" D 0.25"-0.63" H 20"</p>	\$1963

IMAGE	CODE	DESCRIPTION	LIST
<p>24" High (FX)</p>  <p>ADD 2 BSB9 BRACKETS</p>	AC2423.FRS	<p>23" Acrylic Divider [24" High, Square Corners, Beveled Edges] - Frosted Acrylic</p> <p>W 23" D 0.25"-0.63" H 24"</p>	\$515
 <p>ADD 2 BSB9 BRACKETS</p>	AC2429.FRS	<p>29" Acrylic Divider [24" High, Square Corners, Beveled Edges] - Frosted Acrylic</p> <p>W 29" D 0.25"-0.63" H 24"</p>	\$670
 <p>ADD 3 BSB9 BRACKETS</p>	AC2447.FRS	<p>47" Acrylic Divider [24" High, Square Corners, Beveled Edges] - Frosted Acrylic</p> <p>W 47" D 0.25"-0.63" H 24"</p>	\$981
 <p>ADD 3 BSB9 BRACKETS</p>	AC2459.FRS	<p>59" Acrylic Divider [24" High, Square Corners, Beveled Edges] - Frosted Acrylic</p> <p>W 59" D 0.25"-0.63" H 24"</p>	\$1963
 <p>ADD 3 BSB9 BRACKETS</p>	AC2465.FRS	<p>65" Acrylic Divider [24" High, Square Corners, Beveled Edges] - Frosted Acrylic</p> <p>W 65" D 0.25"-0.63" H 24"</p>	\$1963
 <p>ADD 3 BSB9 BRACKETS</p>	AC2471.FRS	<p>71" Acrylic Divider [24" High, Square Corners, Beveled Edges] - Frosted Acrylic</p> <p>W 71" D 0.25"-0.63" H 24"</p>	\$1963

DIVIDERS BRACKETS

IMAGE	CODE	DESCRIPTION	LIST
	BRONS BLK, SLV	Screw-In PET Divider Bracket W 1.5" D 1.11" H 4"	\$83
	BSB9 BLK, SLV, WHT	Divider Bracket (Version 9) [Includes Shims] W 1.5" D 2.38" H 3"	\$50
	BSBACR CHR	Screw-In Divider Bracket [Includes Shims] W 2.19" D 1.25" H 2.19"	\$79
	BSBHL BLK, SLV, WHT	High/Low Divider Brackets, Set of 2 W 3.63" D 3.38" H 5.88"	\$192
	BSBV10 BLK, SLV, WHT	Divider Bracket (Version 10) W 1.5" D 2.75" H 5"	\$50
	BSLM9 BLK, SLV, WHT	Slim Divider Bracket (Version 9) [Includes Shims] W 0.75" D 2.375" H 3"	\$50
	BSLMV10 BLK, SLV, WHT	Slim Divider Bracket (Version 10) W 0.75" D 2.75" H 4.875"	\$50

IMAGE	CODE	DESCRIPTION	LIST
	GBRB1 BLK, SLV	Clamp-On PET Divider Bracket W 2.3" D 1.11" H 5.65"	\$83
	TWMH CHR	Tackboard Wall-Mounting Hardware	\$24

DIVIDERS FABRIC

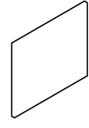
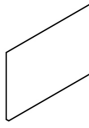




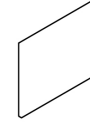
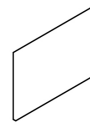
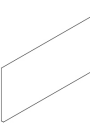



IMAGE	CODE	DESCRIPTION	LIST
<p>20" High</p>  <p>ADD 2 BSBV10 BRACKETS</p>	GBD2023 BLU, GRY	23" Tackable Fabric Divider [20" High] - FAST W 23" D 1" H 20"	\$261
 <p>ADD 2 BSBV10 BRACKETS</p>	GBD2029 BLU, GRY	29" Tackable Fabric Divider [20" High] - FAST W 29" D 1" H 20"	\$297
 <p>ADD 3 BSBV10 BRACKETS</p>	GBD2047 BLU, GRY	47" Tackable Fabric Divider [20" High] - FAST W 47" D 1" H 20"	\$390
 <p>ADD 3 BSBV10 BRACKETS</p>	GBD2059 BLU, GRY	59" Tackable Fabric Divider [20" High] - FAST W 59" D 1" H 20"	\$559
 <p>ADD 3 BSBV10 BRACKETS</p>	GBD2065 BLU, GRY	65" Tackable Fabric Divider [20" High] - FAST W 65" D 1" H 20"	\$582
 <p>ADD 3 BSBV10 BRACKETS</p>	GBD2071 BLU, GRY	71" Tackable Fabric Divider [20" High] - FAST W 71" D 1" H 20"	\$612

IMAGE	CODE	DESCRIPTION	LIST
<p>20" High (FX)</p>  <p>ADD 2 BSBV10 BRACKETS</p>	GFS2023.FXCOM FX-Bryant Park or COM	23" Tackable Fabric Divider [20" High, Requires 0.9 Yards] - FX/COM W 23" D 0.88" H 20"	\$432
 <p>ADD 2 BSBV10 BRACKETS</p>	GFS2029.FXCOM FX-Bryant Park or COM	29" Tackable Fabric Divider [20" High, Requires 1.0 Yards] - FX/COM W 29" D 0.88" H 20"	\$466
 <p>ADD 3 BSBV10 BRACKETS</p>	GFS2047.FXCOM FX-Bryant Park or COM	47" Tackable Fabric Divider [20" High, Requires 1.5 Yards] - FX/COM W 47" D 0.88" H 20"	\$585
 <p>ADD 3 BSBV10 BRACKETS</p>	GFS2059.FXCOM FX-Bryant Park or COM	59" Tackable Fabric Divider [20" High, Requires 1.9 Yards] - FX/COM W 59" D 0.88" H 20"	\$797
 <p>ADD 3 BSBV10 BRACKETS</p>	GFS2065.FXCOM FX-Bryant Park or COM	65" Tackable Fabric Divider [20" High, Requires 2.0 Yards] - FX/COM W 65" D 0.88" H 20"	\$874
 <p>ADD 3 BSBV10 BRACKETS</p>	GFS2071.FXCOM FX-Bryant Park or COM	71" Tackable Fabric Divider [20" High, Requires 2.3 Yards] - FX/COM W 71" D 0.88" H 20"	\$949

DIVIDERS FABRIC

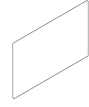
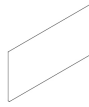
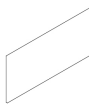
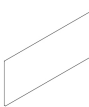
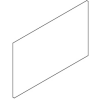
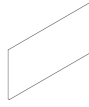
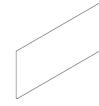
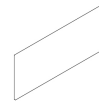
IMAGE	CODE	DESCRIPTION	LIST
<p>30" High</p>  <p>IF SURFACE MOUNTING: ADD 4 BSBV10 BRACKETS</p>	GBD3047 BLU, GRY	47" Tackable Fabric Divider [30" High] - FAST W 47" D 1" H 30"	\$637
 <p>IF SURFACE MOUNTING: ADD 4 BSBV10 BRACKETS</p>	GBD3059 BLU, GRY	59" Tackable Fabric Divider [30" High] - FAST W 59" D 1" H 30"	\$855
 <p>IF SURFACE MOUNTING: ADD 4 BSBV10 BRACKETS</p>	GBD3065 BLU, GRY	65" Tackable Fabric Divider [30" High] - FAST W 65" D 1" H 30"	\$1044
 <p>IF SURFACE MOUNTING: ADD 4 BSBV10 BRACKETS</p>	GBD3071 BLU, GRY	71" Tackable Fabric Divider [30" High] - FAST W 71" D 1" H 30"	\$1097
<p>30" High (FX)</p>  <p>IF SURFACE MOUNTING: ADD 4 BSBV10 BRACKETS</p>	GFS3047.FXCOM FX-Bryant Park or COM	47" Tackable Fabric Divider [30" High, Requires 3.0 Yards] - FX/COM W 47" D 0.88" H 30"	\$909
 <p>IF SURFACE MOUNTING: ADD 4 BSBV10 BRACKETS</p>	GFS3059.FXCOM FX-Bryant Park or COM	59" Tackable Fabric Divider [30" High, Requires 3.8 Yards] - FX/COM W 59" D 0.88" H 30"	\$1221

IMAGE	CODE	DESCRIPTION	LIST
 <p>IF SURFACE MOUNTING: ADD 4 BSBV10 BRACKETS</p>	GFS3065.FXCOM FX-Bryant Park or COM	65" Tackable Fabric Divider [30" High, Requires 4.0 Yards] - FX/COM W 65" D 0.88" H 30"	\$1491
 <p>IF SURFACE MOUNTING: ADD 4 BSBV10 BRACKETS</p>	GFS3071.FXCOM FX-Bryant Park or COM	71" Tackable Fabric Divider [30" High, Requires 4.5 Yards] - FX/COM W 71" D 0.88" H 30"	\$1567







DIVIDERS GLASS

IMAGE	CODE	DESCRIPTION	LIST
13" High  ADD 2 BSB9 BRACKETS	B12GS23 Dry Erase Frosted Glass	23" Dry-Erase Frosted Glass Divider [13" High] W 23" D 0.31" H 13"	\$293
 ADD 2 BSB9 BRACKETS	B12GS29 Dry Erase Frosted Glass	29" Dry-Erase Frosted Glass Divider [13" High] W 29" D 0.31" H 13"	\$333
 ADD 3 BSB9 BRACKETS	B12GS47 Dry Erase Frosted Glass	47" Dry-Erase Frosted Glass Divider [13" High] W 47" D 0.31" H 13"	\$490
 ADD 3 BSB9 BRACKETS	B12GS58 Dry Erase Frosted Glass	58" Dry-Erase Frosted Glass Divider [13" High] W 58" D 0.31" H 13"	\$579
 ADD 3 BSB9 BRACKETS	B12GS70 Dry Erase Frosted Glass	71" Dry-Erase Frosted Glass Divider [13" High] W 71" D 0.31" H 13"	\$692
20" High  ADD 2 BSB9 BRACKETS	BMBGS23 Dry Erase Frosted Glass	23" Dry-Erase Frosted Glass Divider [20" High] W 23" D 0.31" H 20"	\$356

IMAGE	CODE	DESCRIPTION	LIST
 ADD 2 BSB9 BRACKETS	BMBGS29 Dry Erase Frosted Glass	29" Dry-Erase Frosted Glass Divider [20" High] W 29" D 0.31" H 20"	\$411
 ADD 3 BSB9 BRACKETS	BMBGS47 Dry Erase Frosted Glass	47" Dry-Erase Frosted Glass Divider [20" High] W 47" D 0.31" H 20"	\$615
 ADD 3 BSB9 BRACKETS	BMBGS58 Dry Erase Frosted Glass	58" Dry-Erase Frosted Glass Divider [20" High] W 58" D 0.31" H 20"	\$732
 ADD 3 BSB9 BRACKETS	BMBGS71 Dry Erase Frosted Glass	71" Dry-Erase Frosted Glass Divider [20" High] W 71" D 0.31" H 20"	\$882
30" High  IF SURFACE MOUNTING: ADD 2 BSBV10 BRACKETS + 2 RSB10 SHIMS	BMBGS3023 Dry Erase Frosted Glass	23" Dry-Erase Frosted Glass Divider [30" High] W 23" D 0.31" H 30"	\$429
 IF SURFACE MOUNTING: ADD 2 BSBV10 BRACKETS + 2 RSB10 SHIMS	BMBGS3029 Dry Erase Frosted Glass	29" Dry-Erase Frosted Glass Divider [30" High] W 29" D 0.31" H 30"	\$508

DIVIDERS GLASS + PET

IMAGE	CODE	DESCRIPTION	LIST
 <small>IF SURFACE MOUNTING: ADD 4 BSBV10 BRACKETS + 4 RSB10 SHIMS</small>	BMBGS3047 Dry Erase Frosted Glass	47" Dry-Erase Frosted Glass Divider [30" High] W 47" D 0.31" H 30"	\$779
 <small>IF SURFACE MOUNTING: ADD 4 BSBV10 BRACKETS + 4 RSB10 SHIMS</small>	BMBGS3058 Dry Erase Frosted Glass	58" Dry-Erase Frosted Glass Divider [30" High] W 58" D 0.31" H 30"	\$931
 <small>IF SURFACE MOUNTING: ADD 4 BSBV10 BRACKETS + 4 RSB10 SHIMS</small>	BMBGS3071 Dry Erase Frosted Glass	71" Dry-Erase Frosted Glass Divider [30" High] W 71" D 0.31" H 30"	\$1124

IMAGE	CODE	DESCRIPTION	LIST
20" High  <small>ADD 2 BSBV10 BRACKETS</small>	AFD2023 BLK, BLU, GRY, WHT	23" Acoustic Divider [20" High, Beveled Edges] - FAST W 23" D 0.88" H 20"	\$107
 <small>ADD 2 BSBV10 BRACKETS</small>	AFD2029 BLK, BLU, GRY, WHT	29" Acoustic Divider [20" High, Beveled Edges] - FAST W 29" D 0.88" H 20"	\$134
 <small>ADD 3 BSBV10 BRACKETS</small>	AFD2047 BLK, BLU, GRY, WHT	47" Acoustic Divider [20" High, Beveled Edges] - FAST W 47" D 0.88" H 20"	\$213
 <small>ADD 3 BSBV10 BRACKETS</small>	AFD2059 BLK, BLU, GRY, WHT	59" Acoustic Divider [20" High, Beveled Edges] - FAST W 59" D 0.88" H 20"	\$266
 <small>ADD 3 BSBV10 BRACKETS</small>	AFD2065 BLK, BLU, GRY, WHT	65" Acoustic Divider [20" High, Beveled Edges] - FAST W 65" D 0.88" H 20"	\$293
 <small>ADD 3 BSBV10 BRACKETS</small>	AFD2071 BLK, BLU, GRY, WHT	71" Acoustic Divider [20" High, Beveled Edges] - FAST W 71" D 0.88" H 20"	\$320

STORAGE LAMINATE

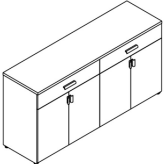

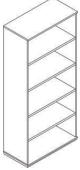
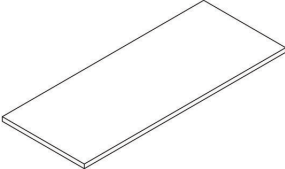
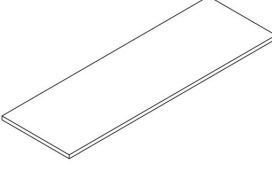
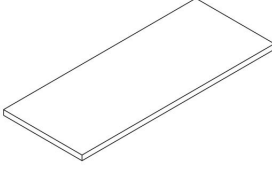
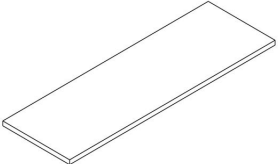
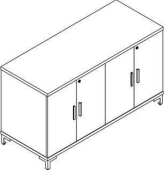
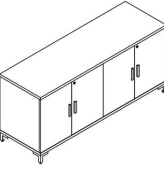
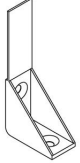
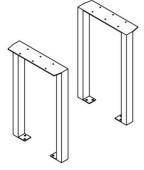
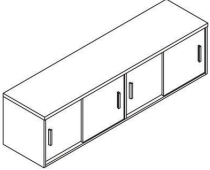
IMAGE	CODE	DESCRIPTION	LIST
	GBBC71 ELM1, OAK1, SAH1, WHT	71" Laminate Buffet Credenza [36" High] - FAST W 71" D 20" H 36"	\$4829
Bookcases	BLBCD ELM1, OAK1, SAH1, WHT	15.75" Laminate Bookcase Door Kit, Set of 2 [42" High] - FAST W 15.75" D 0.75" H 42"	\$322
			
	KIT-BLBC72 ELM1, OAK1, SAH1, WHT	31.5" Laminate Bookcase [72" High] - FAST W 31.5" D 15.75" H 72"	\$1094
Credenza Tops	BLRT48 ELM1	49"x20" Laminate Conference Credenza Top [1" Thick] - FAST W 49" D 20" H 1"	\$243
			
	BLRT60 ELM1	61.5"x20" Laminate Conference Credenza Top [1" Thick] - FAST W 61.5" D 20" H 1"	\$322
Credenza Tops (FX)	WALAMCC.A FX	49"x20" Laminate Top [1.25" Thick, For 48" Laminate Conference Credenza] - FX W 49" D 20" H 1.25"	\$1077
			

IMAGE	CODE	DESCRIPTION	LIST
	WALAMCC.B FX	61.5"x20" Laminate Top [1.25" Thick, For 60" Laminate Conference Credenza] - FX W 61.5" D 20" H 1.25"	\$1272
Credenzas	BLCC48 ELM1, OAK1, SAH1, WHT	48" Laminate Conference Credenza [28.5" High] - FAST W 49.13" D 20" H 28.35"	\$1286
			
	BLCC60 ELM1, OAK1, SAH1, WHT	60" Laminate Conference Credenza [28.5" High] - FAST W 61.5" D 20" H 28.35"	\$1447
Hardware	KIT-LCCB WHT	Laminate Storage L-Bracket [For FAST/FX Laminate Top, Includes Laminate-to-Laminate Hardware]	\$0.01
			
Hutch Stands	KIT-BSHS24 BLK, SLV, WHT	Shared Hutch Stands, Set of 2 [24" High, Includes Hardware] W 15" D 3.88" H 24"	\$420
			
Hutches	BSDH60V3-K ELM1, OAK1, SAH1, WHT	59" Laminate Sliding-Door Hutch (V3) [16" High, Includes Wall-Mounting Hardware] - FAST W 59" D 15" H 16"	\$739
			

STORAGE LAMINATE

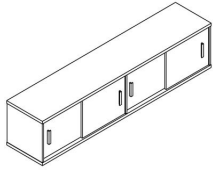
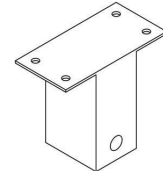

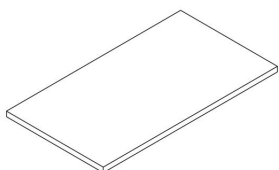
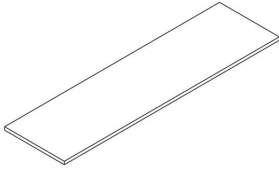
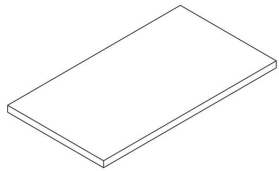
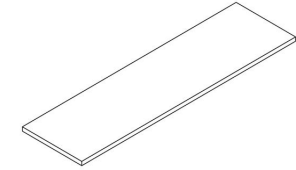

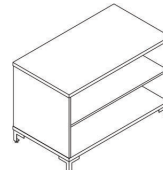
IMAGE	CODE	DESCRIPTION	LIST
	BSDH71V3-K ELM1, OAK1, SAH1, WHT	71" Laminate Sliding-Door Hutch (V3) [16" High, Includes Wall-Mounting Hardware] - FAST W 71" D 15" H 16"	\$983
Lateral Accessories	BLSS BLK, SLV, WHT	Surface Stand Kit, Set of 2 [3.5" High] W 1.97" D 3.94" H 3.35"	\$82
			
	LSF BLK, WHT	Laminate Storage Foot, Set of 4 W 3.62" D 3.62" H 3.82"	\$78
			
Lateral Tops	BLLRT ELM1, OAK1, SAH1, WHT	36"x20" Laminate Top [1" Thick, For BLLBFV2 and BLLOSV2] - FAST W 36" D 20" H 1"	\$290
			
	GBLLT2 FFIN2	72"x20" Laminate Lateral-Merging Top [1" Thick] - FAST W 72" D 20" H 1"	\$338
			
Lateral Tops (FX)	WALAMLF.A FX	36"x20" Laminate Top [1.25" Thick, For Single Laminate Lateral File] - FX W 36" D 20" H 1.25"	\$1017
			

IMAGE	CODE	DESCRIPTION	LIST
	WALAMLF.B FX	72"x20" Laminate Top [1.25" Thick, For Merged Laminate Lateral Files] - FX W 72" D 20" H 1.25"	\$1272
Laterals	BLLBFV2 ELM1, OAK1, SAH1, WHT	36" Laminate Low Box/File Lateral (V2) [24.5" High] - FAST W 36" D 20" H 24"	\$1126
			
	BLLOSV2 ELM1, OAK1, SAH1, WHT	36" Laminate Low Open Shelf Lateral (V2) [24.5" High] - FAST W 36" D 20" H 24"	\$628
			

STORAGE STEEL


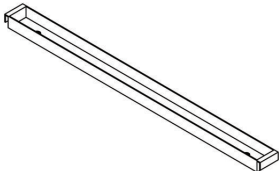
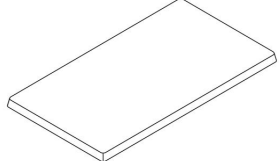
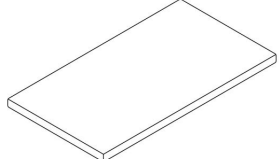
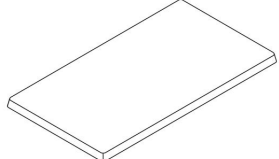
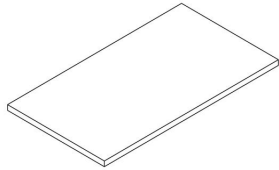
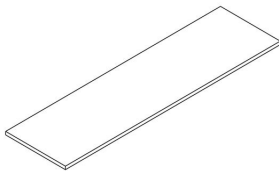
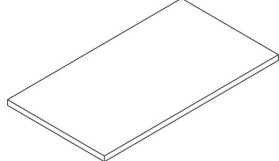
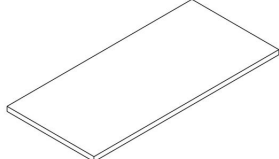
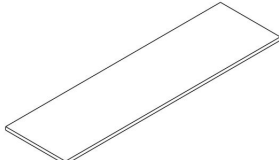
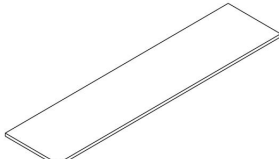
IMAGE	CODE	DESCRIPTION	LIST
Lateral Accessories 	BLLFCS BLK	Lateral Caster Kit, Set of 4 [For Steel Low Laterals] W 2.75" D 2.5" H 3"	\$158
	FK1 BLK	Lateral Front-to-Back File Hanging Rail (Short), Set of 2 W 1" D 15" H 0.5"	\$58
Lateral Cushions 	BS2036T GRN, BLU, GRY, MID	36"x20" Lateral Cushion [Rounded Corners] - FAST W 36" D 19.5" H 1.5"	\$388
	GS2036 BLU, GRY	36"x20" Lateral Cushion [Square Corners] - FAST W 36" D 19.5" H 1.5"	\$388
	GS2042-FXCOM FX-Bryant Park or COM	Upholstered 42"x20" Lateral Cushion W 42" D 19.5" H 1.5	\$512
	GS2042-UPH BLU, GRY, FX, COM	42"x20" Lateral Cushion [Square Corners] W 42" D 19.5" H 1.5	\$512
Lateral Cushions (FX) 	BS2036T.FXCOM FX-Bryant Park or COM	36"x20" Lateral Cushion [Requires 1 Yard] - FX/COM W 36" D 19.5" H 1.5"	\$512

IMAGE	CODE	DESCRIPTION	LIST
Lateral Tops 	GBSTL1 ELM1, OAK1, SAH1, WHT	35.5"x19.75" Laminate Top [1" Thick, For Steel Lateral] - FAST W 35.5" D 19.75" H 1"	\$416
	GBSTL2 ELM1, OAK1, SAH1, WHT	71"x19.75" Laminate Top [1" Thick, For Steel Lateral] - FAST W 71" D 19.75" H 1"	\$702
Lateral Tops (FX) 	WALAMSTL.A FX	35.5"x19.75" Laminate Top [1.25" Thick, For Steel Lateral] - FX W 35.5" D 19.75" H 1.25"	\$1017
	WALAMSTL.B FX	42"x19.75" Laminate Top [1.25" Thick, For Steel Lateral] - FX W 42" D 19.75" H 1.25"	\$1054
	WALAMSTL.C FX	71"x19.75" Laminate Top [1.25" Thick, For Steel Lateral] - FX W 71" D 19.75" H 1.25"	\$1272
	WALAMSTL.D FX	84"x19.75" Laminate Top [1.25" Thick, For Steel Lateral] - FX W 84" D 19.75" H 1.25"	\$1562

STORAGE STEEL

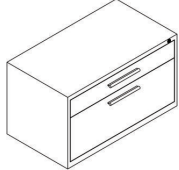
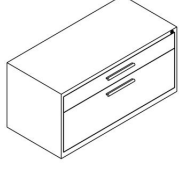
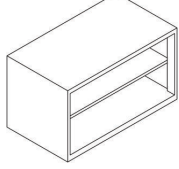
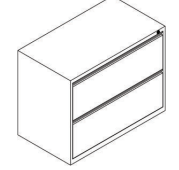
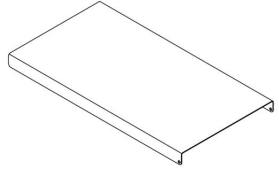
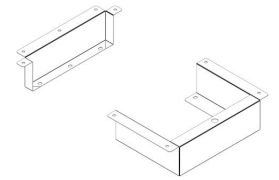
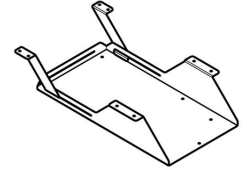
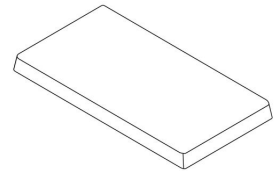
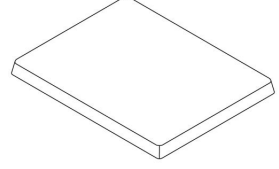
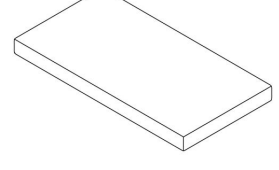
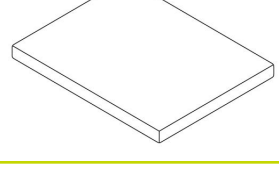
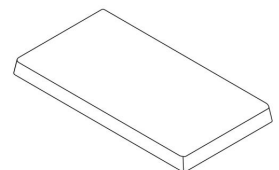
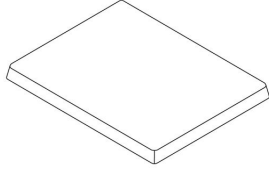


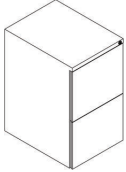
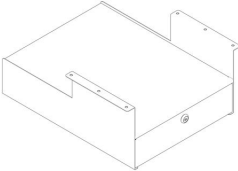
IMAGE	CODE	DESCRIPTION	LIST
Laterals 	BLLF36 BLK, SLV, WHT	36" Steel Low Box/File Lateral [20" High] W 35.5" D 19.75" H 20"	\$1274
	BLLF42 SLV, WHT	42" Steel Low Box/File Lateral [20" High] W 42" D 19.75" H 20"	\$1475
	BSBC36 BLK, SLV, WHT	36" Steel Low Open Shelf Lateral [20" High] W 35.5" D 19.75" H 20"	\$865
	BSLF36 BLK, SLV, WHT	36" Steel File/File Lateral [27.5" High] W 35.5" D 19.75" H 27.36"	\$1591
Pedestal Accessories 	BFSLM.CAP BLK, SLV, WHT	Slim Pedestal Cap [Includes Double-Sided Tape] W 10.08" D 19.14" H 1.19"	\$47
	BFSLM.HW CHR	Surface-Mount Hardware [For Slim Pedestal]	\$0.01
	BFSLM.SM BLK, SLV, WHT	Surface-Mount Brackets [For Slim Pedestal] W 12.38" D 20.25" H 3.13"	\$129

IMAGE	CODE	DESCRIPTION	LIST
	BFSLM.UB BLK, SLV, WHT	Universal Surface-Mount Bracket [For Slim Pedestal, Includes Non-Slip Mat and Hardware] W 12.24" D 19.10"-21.25" H 4.38"	\$188
Pedestal Cushions 	BS1910T GRN, BLU, GRY, MID	19"x10" Slim Pedestal Cushion [Rounded Corners] - FAST W 10" D 19" H 1.5"	\$160
	BS1915T GRN, BLU, GRY, MID	19"x15" Pedestal Cushion [Rounded Corners] - FAST W 15" D 19" H 1.5"	\$186
	GS1910 BLU, GRY	19"x10" Slim Pedestal Cushion [Square Corners] - FAST W 10" D 19" H 1.5"	\$160
	GS1915 BLU, GRY	19"x15" Pedestal Cushion [Square Corners] - FAST W 15" D 19" H 1.5"	\$186
Pedestal Cushions (FX) 	BS1910T.FXCOM FX-Bryant Park or COM	19"x10" Slim Pedestal Cushion - FX/COM W 10" D 19" H 1.5"	\$369

STORAGE STEEL

IMAGE	CODE	DESCRIPTION	LIST
	BS1915T.FXCOM FX-Bryant Park or COM	19"x15" Pedestal Cushion [Requires 0.5 Yards] - FX/COM W 15" D 19" H 1.5"	\$483
Pedestals	BFSLM BLK, SLV, WHT	Steel Mobile Box/File Slim Pedestal W 10" D 19.14" H 22.13"	\$674
 ADD 1 CAP OR 1 SURFACE-MT BRACKET OR 1 CUSHION			
	BSBBF BLK, SLV, WHT	Steel Mobile Box/Box/File Pedestal [22" High] W 15.25" D 19.75" H 22"	\$723
	BSCWFF BLK, SLV, WHT	Steel File/File Pedestal [25" High, Includes Counterweight] W 14.75" D 19.75" H 25.5"	\$918
Storage Drawer	BSMPS BLK, SLV, WHT	Steel Personal Storage Drawer [Locking, Surface-Mount] W 15.36" D 17.92" H 7.83"	\$366
			

POWER CONNECTOR BLOCKS + DUPLEXES

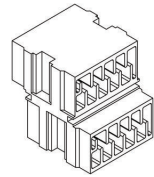
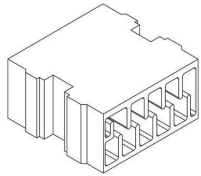
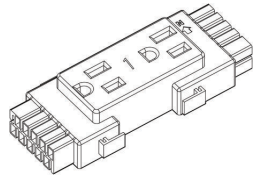
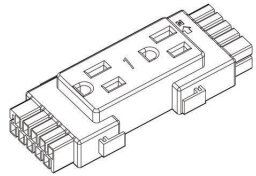
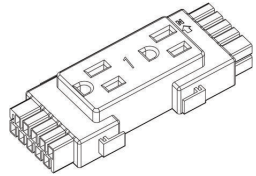
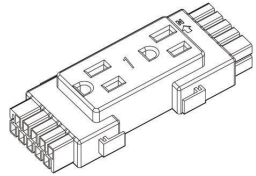
IMAGE	CODE	DESCRIPTION	LIST
	BPJCB BLK	4-Way Connector Block W 1.65" D 1.82" H 1.73"	\$25
	BPPCB BLK	2-Way Connector Block W 1.65" D 1.47" H 0.78"	\$25

IMAGE	CODE	DESCRIPTION	LIST
	BPDR_C1 BLK	Duplex Receptacle (Configuration 1) [2 Outlets] W 4.65" D 0.1" H 1.95"	\$27
	BPDR_C2 BLK	Duplex Receptacle (Configuration 2) [2 Outlets] W 4.65" D 0.1" H 1.95"	\$27
	BPDR_C3 BLK	Duplex Receptacle (Configuration 3) [2 Outlets] W 4.65" D 0.1" H 1.95"	\$27
	BPDR_T24_C4 BLK	Duplex Receptacle (Configuration 4) [2 Outlets, Title 24 Compliant] W 4.65" D 0.1" H 1.95"	\$27

POWER HARNESSES + INFEEDS

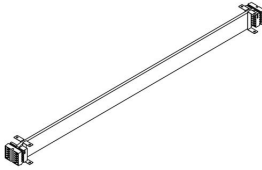
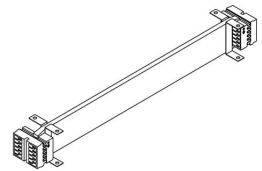
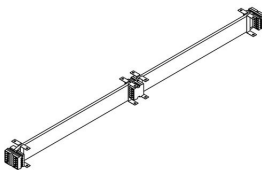
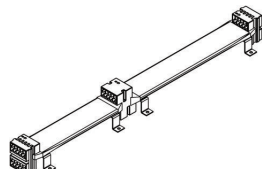
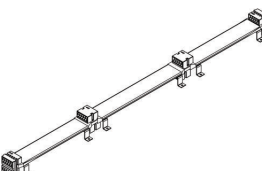
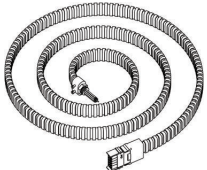
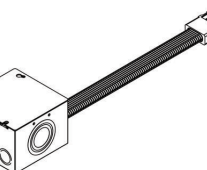
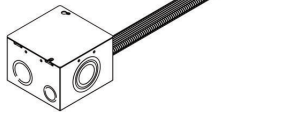

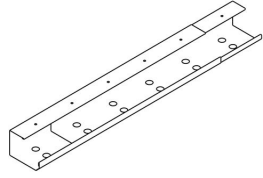
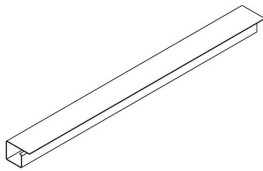
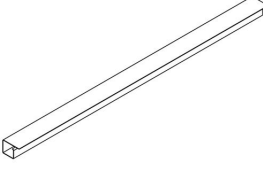
IMAGE	CODE	DESCRIPTION	LIST
BLADE Harnesses 	KIT-HARNESS SLV	BLADE 36" Harness [Requires 4 Duplex Receptacles, 8 Outlets] W 36.63" D 2.18" H 2.4"	\$413
	KIT-HARNESS-4 SLV	BLADE 18" Harness [Requires 4 Duplex Receptacles, 8 Outlets] W 18.63" D 2.18" H 2.4"	\$413
	KIT-HARNESS-8 SLV	BLADE 36" Harness [Requires 8 Duplex Receptacles, 16 Outlets, For 120 Degree Workstation] W 36.63" D 2.18" H 2.4"	\$413
BOOST Harnesses 	KIT-HARNESS-B24 SLV	BOOST 24" Harness [Requires 4 Duplex Receptacles, 8 Outlets, For 48" & 120 Degree Bridge Beams] W 25.63" D 3" H 2.17"	\$413
	KIT-HARNESS-B36 SLV	BOOST 36" Harness [Requires 6 Duplex Receptacles, 12 Outlets, For 60"-72" Bridge Beams] W 36.88" D 3" H 2.17"	\$413

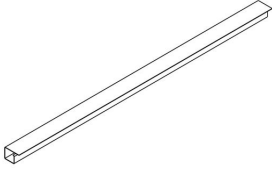
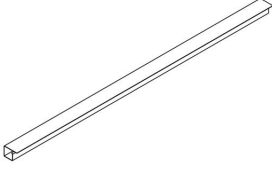
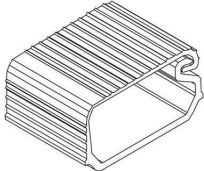

IMAGE	CODE	DESCRIPTION	LIST
	BPIF164 SLV	164" In-Feed W 164" D 0.87" H 1.95"	\$579
	BPIF72 SLV	60" In-Feed W 60" D 0.87" H 1.95"	\$355
	KIT-NYC SLV	12" In-Feed Kit [NYC Electrical Code Compliant]	\$928

POWER JUMPERS + WIRE MANAGEMENT

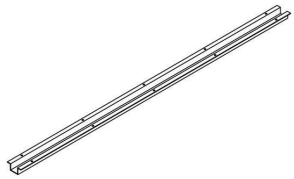
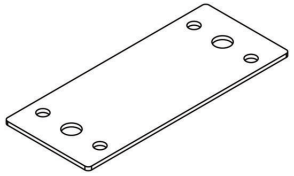
IMAGE	CODE	DESCRIPTION	LIST
	BPJ12 SLV	12" Jumper W 12" D 0.87" H 1.95"	\$226
	BPJ144 SLV	144" Jumper W 144" D 0.87" H 1.95"	\$598
	BPJ15 SLV	15" Jumper W 15" D 0.87" H 1.95"	\$235
	BPJ18 SLV	18" Jumper W 18" D 0.87" H 1.95"	\$235
	BPJ29 SLV	29" Jumper W 29" D 0.87" H 1.95"	\$239
	BPJ42 SLV	42" Jumper W 42" D 0.87" H 1.95"	\$239
	BPJ72 SLV	72" Jumper W 72" D 0.87" H 1.95"	\$273

IMAGE	CODE	DESCRIPTION	LIST
Infeed Management 	KIT-PPOLE BLK, RAW, SLV, WHT	144" Power Pole, 2-Piece [Includes Bracket & Trim Plate] W 3.18" D 1.6" H 144"	\$380
Under-Surface Wire Management 	BHCT BLK, SLV, WHT	Surface-Mount Cable Management Tray W 25"-45" D 4.11" H 2.96"	\$204
	BMZ.24 BLK	24" Braided Mesh Zipper Wire Manager H 24"	\$119
	BMZ.48 BLK	48" Braided Mesh Zipper Wire Manager H 48"	\$146
	BSF6.48 BLK	48" Braided Mesh Tube Wire Manager W 48" D 1.25" H 1.25"	\$100
	BWMJC.24 BLK	24" Cable J-Channel W 24" D 2" H 1"	\$86
	BWMJC.36 BLK	36" Cable J-Channel W 36" D 2" H 1"	\$86

POWER WIRE MANAGEMENT

IMAGE	CODE	DESCRIPTION	LIST
	BWMJC.42 BLK	42" Cable J-Channel W 42" D 2" H 1"	\$86
	BWMJC.47 BLK	47" Cable J-Channel W 47" D 2" H 1"	\$86
	JC1 BLK	1" Cable J-Clip [Includes Hardware] W 1" D 1.5" H 0.875"	\$9
	MGCC BLK	Flexible Cable Chain [Includes 46 Links; Magnetic/Screw-Mount Base] W 2" D 2" H 37.75"-46.75"	\$279

SUPPORTS SUPPORTS

IMAGE	CODE	DESCRIPTION	LIST
	BASB72 SLV	42" Support Bar W 41.69" D 1.88" H 0.88"	\$160
	BFB1 SLV	Flat Bracket W 4.69" D 1.94" H 0.06"	\$7

ACCESSORIES MONITOR ARM + POWER & DATA UNITS

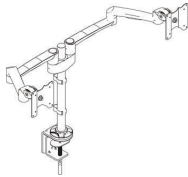
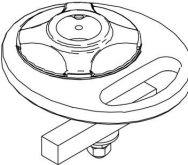
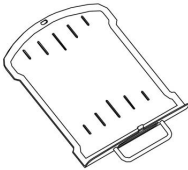
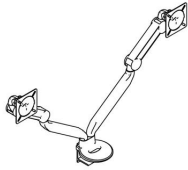
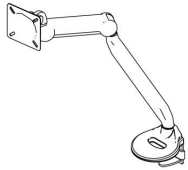
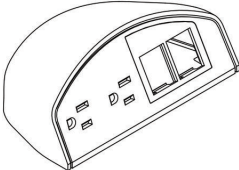
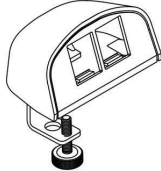
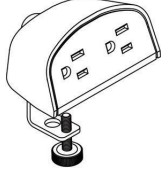
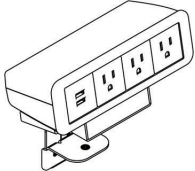
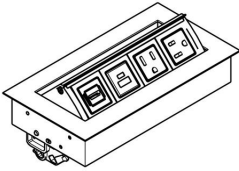
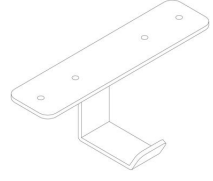
IMAGE	CODE	DESCRIPTION	LIST
	BMA2 BLK, SLV, WHT	Dual Monitor Arm [Includes Edge Mount] W 22"-35" D 4"-22" H 6.5"-20"	\$836
	BMAGM BLK, SLV, WHT	Grommet-Mount Adapter [For Dual Monitor Arm] W 4.72" D 5.51" H 0.5"	\$65
	NXLT BLK, SLV, WHT	NEXUS Laptop Tray [For Dual Monitor Arm] W 11.02"-15.35" D 11.89" H 0.67"-1.54"	\$136
	NXMA BLK, SLV, WHT	NEXUS Dual Monitor Arm [Includes Edge/Grommet Mount and VESA Quick-Release System] W 36.14" D 5.91" H 7.36"-18.39"	\$682
	NXSMA BLK, SLV, WHT	NEXUS Single Monitor Arm [Includes Edge/Grommet Mount and VESA Quick-Release System]	\$367

IMAGE	CODE	DESCRIPTION	LIST
Desktop Units 	BMFDAV2 BLK, WHT	Desktop Combo Unit [2 Power Outlets, 2 Data Ports, 72" Cord] W 6.2" D 3.88" H 2.31"	\$349
	BPDMA BLK	Desktop Data Unit [2 Data Ports, 72" Cord] W 3.7" D 2.43" H 1.85"	\$280
	BPMA BLK, WHT	Desktop Power Unit [2 Power Outlets, 72" Cord] W 3.7" D 2.86" H 1.85"	\$280
	DPU320 WHT	Desktop Power Unit Plus [3 Power Outlets, Dual USB, 108" Cord] W 6.65" D 2.21" H 3.75"	\$362
Grommet Units	SGPWR BLK, WHT	Grommet Power Unit [60mm, 1 Power Outlet, 72" Cord] W 2.62" D 2.62" H 0.2"	\$164
	SGUSB BLK, WHT	Grommet USB Unit [60mm, 1 Dual USB, 72" Cord] W 2.62" D 2.62" H 0.2"	\$438
In-Surface Units 	ISPU BLK, SLV, WHT	In-Surface Power Unit [2 Power Outlets, 1 Dual USB A+C, 1 HDMI Port, 72" Cord] W 8.31" D 4.42" H 1.15"	\$1404

ACCESSORIES POWER & DATA UNITS + STORAGE HOOK

IMAGE	CODE	DESCRIPTION	LIST
<p>Under-Surface Units</p> 	<p>BPUSM BLK</p>	<p>Under-Surface Combo Unit [1 Power Outlet, Dual USB, 72" Cord] W 4.05" D 2.77" H 1.69"</p>	<p>\$482</p>

IMAGE	CODE	DESCRIPTION	LIST
	<p>PSH BLK, SLV, WHT</p>	<p>Personal Storage Hook W 6" D 2.32" H 2.63"</p>	<p>\$34</p>

WILLOW PARK ACACIA SERIES

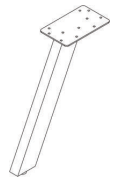
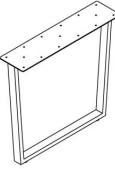
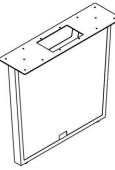
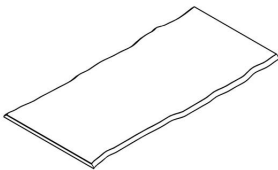
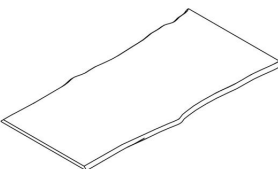
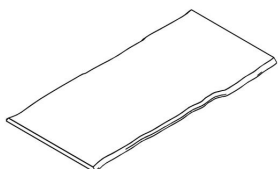
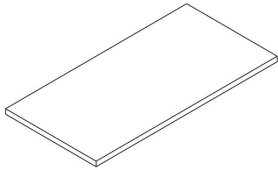
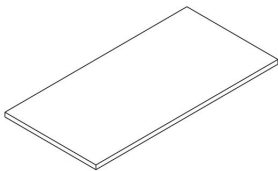
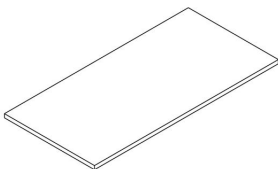

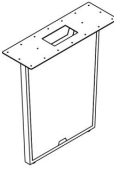
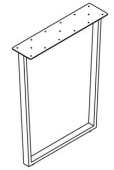
IMAGE	CODE	DESCRIPTION	LIST
Cutout Fee	ATPF	Wood Table Processing Fee [One 4"x8" Cutout]	\$465
Legs	APL BLK, SLV, WHT	Angled Post Leg [27.5" High] W 7.87" D 12.6" H 27.36"	\$152
			
	GCNAB BLK, SLV, WHT	THREE60 Angled Sleigh Leg W 30" D 7.28" H 27.36"	\$781
			
	GCNABCOV BLK, SLV, WHT	THREE60 Angled Sleigh Leg [Covered For Wire Management] W 30" D 7.28" H 27.36"	\$861
			
Live-Edge	LE3672.32V2-AO ACW-Acacia Wood	36"x72" Live-Edge Wood Top (V2) [32mm Thick] - FAST W 72" D 36" H 1.27"	\$2099
			
	LE4284.32V2-AO ACW-Acacia Wood	42"x84" Live-Edge Wood Top (V2) [32mm Thick] - FAST W 84" D 42" H 1.27"	\$3517
			
	LE4796.48V2-AO ACW-Acacia Wood	47"x96" Live-Edge Wood Top (V2) [48mm Thick] - FAST W 96" D 47" H 1.89"	\$3832
			

IMAGE	CODE	DESCRIPTION	LIST
Square-Edge	SE3672.48-AO ACW-Acacia Wood	36"x72" Square-Edge Wood Top [48mm Thick] - FAST W 72" D 36" H 1.89"	\$1837
			
	SE4284.48-AO ACW-Acacia Wood	42"x84" Square-Edge Wood Top [48mm Thick] - FAST W 84" D 42" H 1.89"	\$3149
			
	SE4796.48-AO ACW-Acacia Wood	47"x96" Square-Edge Wood Top [48mm Thick] - FAST W 96" D 47" H 1.89"	\$3254
			
Standing-Height Legs	APLSH BLK, SLV, WHT	Angled Standing-Height Post Leg [38.25" High] W 7.87" D 16.81" H 38.39"	\$216
			
	GCNABCOVSH BLK, SLV, WHT	THREE60 Standing-Height Angled Sleigh Leg [Covered For Wire Management] W 35" D 11.81" H 38.39"	\$1112
			
	GCNABSHV2 BLK, SLV, WHT	THREE60 Standing-Height Angled Sleigh Leg (V2) W 30" D 7.28" H 38.39"	\$905
			

WILLOW PARK ACACIA SERIES

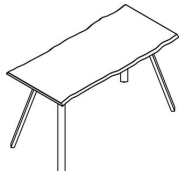
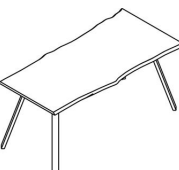
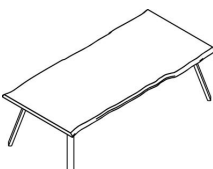
IMAGE	CODE	DESCRIPTION	LIST
Support Brace 	GCNABSHLE BLK, SLV, WHT	THREE60 Support Brace [For Standing-Height Angled Sleigh Leg] W 3" D 26.34" H 38.11"	\$265
TYPICALS			
	ACLP3672 ACW-Acacia Wood	36"x72" Live-Edge Acacia Table [Angled Post Legs] W 72" D 36" H 28.62"	\$2704
	ACLP3672-SH ACW-Acacia Wood	36"x72" Live-Edge Acacia Table [Standing-Height Angled Post Legs] W 72" D 36" H 39.65"	\$2960
	ACLP4284 ACW-Acacia Wood	42"x84" Live-Edge Acacia Table [Angled Post Legs] W 84" D 42" H 28.62"	\$4122
	ACLP4284-SH ACW-Acacia Wood	42"x84" Live-Edge Acacia Table [Standing-Height Angled Post Legs] W 84" D 42" H 39.65"	\$4378
	ACLP4796 ACW-Acacia Wood	47"x96" Live-Edge Acacia Table [Angled Post Legs] W 96" D 47" H 29.25"	\$4437

IMAGE	CODE	DESCRIPTION	LIST
	ACLP4796-SH ACW-Acacia Wood	47"x96" Live-Edge Acacia Table [Standing-Height Angled Post Legs] W 96" D 47" H 40.28"	\$4693
	ACLS3672 ACW-Acacia Wood	36"x72" Live-Edge Acacia Table [Angled Sleigh Legs] W 72" D 36" H 28.62"	\$3660
	ACLS3672-SH ACW-Acacia Wood	36"x72" Live-Edge Acacia Table [Standing-Height Angled Sleigh Legs] W 72" D 36" H 39.65"	\$4437
	ACLS4284 ACW-Acacia Wood	42"x84" Live-Edge Acacia Table [Angled Sleigh Legs] W 84" D 42" H 28.62"	\$5077
	ACLS4284-SH ACW-Acacia Wood	42"x84" Live-Edge Acacia Table [Standing-Height Angled Sleigh Legs] W 84" D 42" H 39.65"	\$5854
	ACLS4796 ACW-Acacia Wood	47"x96" Live-Edge Acacia Table [Angled Sleigh Legs] W 96" D 47" H 29.25"	\$5392
	ACLS4796-SH ACW-Acacia Wood	47"x96" Live-Edge Acacia Table [Standing-Height Angled Sleigh Legs] W 96" D 47" H 40.28"	\$6169

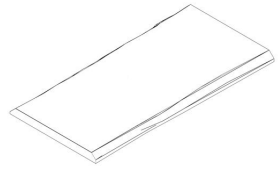
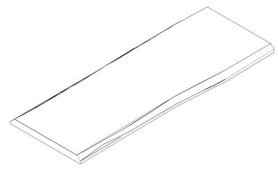

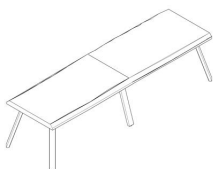

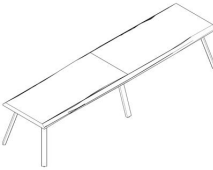
WILLOW PARK ACACIA SERIES

IMAGE	CODE	DESCRIPTION	LIST
	ACSP3672 ACW-Acacia Wood	36"x72" Square-Edge Acacia Table [Angled Post Legs] W 72" D 36" H 29.25"	\$2442
	ACSP3672-SH ACW-Acacia Wood	36"x72" Square-Edge Acacia Table [Standing-Height Angled Post Legs] W 72" D 36" H 40.28"	\$2698
	ACSP4284 ACW-Acacia Wood	42"x84" Square-Edge Acacia Table [Angled Post Legs] W 84" D 42" H 29.25"	\$3754
	ACSP4284-SH ACW-Acacia Wood	42"x84" Square-Edge Acacia Table [Standing-Height Angled Post Legs] W 84" D 42" H 40.28"	\$4010
	ACSP4796 ACW-Acacia Wood	47"x96" Square-Edge Acacia Table [Angled Post Legs] W 96" D 47" H 29.25"	\$3859
	ACSP4796-SH ACW-Acacia Wood	47"x96" Square-Edge Acacia Table [Standing-Height Angled Post Legs] W 96" D 47" H 40.28"	\$4115
	ACSS3672 ACW-Acacia Wood	36"x72" Square-Edge Acacia Table [Angled Sleigh Legs] W 72" D 36" H 29.25"	\$3397

IMAGE	CODE	DESCRIPTION	LIST
	ACSS3672-SH ACW-Acacia Wood	36"x72" Square-Edge Acacia Table [Standing-Height Angled Sleigh Legs] W 72" D 36" H 40.28"	\$4174
	ACSS4284 ACW-Acacia Wood	42"x84" Square-Edge Acacia Table [Angled Sleigh Legs] W 84" D 42" H 29.25"	\$4710
	ACSS4284-SH ACW-Acacia Wood	42"x84" Square-Edge Acacia Table [Standing-Height Angled Sleigh Legs] W 84" D 42" H 40.28"	\$5487
	ACSS4796 ACW-Acacia Wood	47"x96" Square-Edge Acacia Table [Angled Sleigh Legs] W 96" D 47" H 29.25"	\$4815
	ACSS4796-SH ACW-Acacia Wood	47"x96" Square-Edge Acacia Table [Standing-Height Angled Sleigh Legs] W 96" D 47" H 40.28"	\$5592

WILLOW PARK CAMPANO COLLECTION

IMAGE	CODE	DESCRIPTION	LIST
Legs 	SHLAT4 BLACK	Steel Hairpin Legs for Accent Table, Set of 4 W 3" D 15" H 15"	\$277
Live-Edge 	WSCB120-CAP CWSLA-Campano Wood Slab	Campano 120" Live-Edge Solid Wood Slab Surface [2 Piece] W 120" D 30"-40" H 3"	\$16829
	WSCB144-CAP CWSLA-Campano Wood Slab	Campano 144" Live-Edge Solid Wood Slab Surface [2 Piece] W 144" D 30"-40" H 3"	\$19495
	WSCB24-CAP CWSLA-Campano Wood Slab	Campano 24" Live-Edge Solid Wood Slab Surface W 24" D 30"-40" H 3"	\$2199
	WSCB48-CAP CWSLA-Campano Wood Slab	Campano 48" Live-Edge Solid Wood Slab Surface W 48" D 30"-40" H 3"	\$3940
	WSCB60-CAP CWSLA-Campano Wood Slab	Campano 60" Live-Edge Solid Wood Slab Surface W 60" D 30"-40" H 3"	\$5910

IMAGE	CODE	DESCRIPTION	LIST
	WSCB72-CAP CWSLA-Campano Wood Slab	Campano 72" Live-Edge Solid Wood Slab Surface W 72" D 30"-40" H 3"	\$5910
	WSCB96-CAP CWSLA-Campano Wood Slab	Campano 96" Live-Edge Solid Wood Slab Surface W 96" D 30"-40" H 3"	\$9199
Side Tables 	WSCBST-CAP CWSLA-Campano Wood Slab	Campano Round Live-Edge Solid Wood Stool Table W 12" D 12" H 18"	\$699
Typicals 	CCAP120 CWSLA-Campano Wood Slab	Campano Collection 120" Live-Edge Table [Seated-Height Angled Post Legs] W 120" D 30"-40" H 30.38"	\$17741
	CCAP120-SH CWSLA-Campano Wood Slab	Campano Collection 120" Live-Edge Table [Standing-Height Angled Post Leg] W 120" D 30"-40" H 41.40"	\$18125
	CCAP144 CWSLA-Campano Wood Slab	Campano Collection 144" Live-Edge Table [Seated-Height Angled Post Legs] W 144" D 30"-40" H 30.38"	\$20407

WILLOW PARK CAMPANO COLLECTION

IMAGE	CODE	DESCRIPTION	LIST
	CCAP144-SH CWSLA-Campano Wood Slab	Campano Collection 144" Live-Edge Table [Standing-Height Angled Post Leg] W 144" D 30"-40" H 41.40"	\$20791
	CCAP60 CWSLA-Campano Wood Slab	Campano Collection 60" Live-Edge Table [Seated-Height Angled Post Legs] W 60" D 30"-40" H 30.38"	\$6518
	CCAP60-SH CWSLA-Campano Wood Slab	Campano Collection 60" Live-Edge Table [Standing-Height Angled Post Leg] W 60" D 30"-40" H 41.40"	\$6774
	CCAP72 CWSLA-Campano Wood Slab	Campano Collection 72" Live-Edge Table [Seated-Height Angled Post Legs] W 72" D 30"-40" H 30.38"	\$6518
	CCAP72-SH CWSLA-Campano Wood Slab	Campano Collection 72" Live-Edge Table [Standing-Height Angled Post Leg] W 72" D 30"-40" H 41.40"	\$6774
	CCAP96 CWSLA-Campano Wood Slab	Campano Collection 96" Live-Edge Table [Seated-Height Angled Post Legs] W 96" D 30"-40" H 30.38"	\$9807
	CCAP96-SH CWSLA-Campano Wood Slab	Campano Collection 96" Live-Edge Table [Standing-Height Angled Post Leg] W 96" D 30"-40" H 41.40"	\$10063

IMAGE	CODE	DESCRIPTION	LIST
	CCAT24 CWSLA-Campano Wood Slab	Campano Collection 24" Accent Table [Hairpin Legs] W 24" D 30"-40" H 17.75"	\$2476
	CCAT48 CWSLA-Campano Wood Slab	Campano Collection 48" Accent Table [Hairpin Legs] W 48" D 30"-40" H 17.75"	\$4217
	CCSL120 CWSLA-Campano Wood Slab	Campano Collection 120" Live-Edge Table [Seated-Height Angled Sleigh Leg] W 120" D 30"-40" H 30.38"	\$19172
	CCSL120-SH CWSLA-Campano Wood Slab	Campano Collection 120" Live-Edge Table [Standing-Height Angled Sleigh Leg] W 120" D 30"-40" H 41.40"	\$20074
	CCSL144 CWSLA-Campano Wood Slab	Campano Collection 144" Live-Edge Table [Seated-Height Angled Sleigh Leg] W 144" D 30"-40" H 30.38"	\$21838
	CCSL144-SH CWSLA-Campano Wood Slab	Campano Collection 144" Live-Edge Table [Standing-Height Angled Sleigh Leg] W 144" D 30"-40" H 41.40"	\$22740
	CCSL60 CWSLA-Campano Wood Slab	Campano Collection 60" Live-Edge Table [Seated-Height Angled Sleigh Leg] W 60" D 30"-40" H 30.38"	\$7472

WILLOW PARK CAMPANO COLLECTION + LOUNGE TABLES

IMAGE	CODE	DESCRIPTION	LIST
	CCSL60-SH CWSLA-Campano Wood Slab	Campano Collection 60" Live-Edge Table [Standing-Height Angled Sleigh Leg] W 60" D 30"-40" H 41.40"	\$7720
	CCSL72 CWSLA-Campano Wood Slab	Campano Collection 72" Live-Edge Table [Seated-Height Angled Sleigh Leg] W 72" D 30"-40" H 30.38"	\$7472
	CCSL72-SH CWSLA-Campano Wood Slab	Campano Collection 72" Live-Edge Table [Standing-Height Angled Sleigh Leg] W 72" D 30"-40" H 41.40"	\$8250
	CCSL96 CWSLA-Campano Wood Slab	Campano Collection 96" Live-Edge Table [Seated-Height Angled Sleigh Leg] W 96" D 30"-40" H 30.38"	\$10761
	CCSL96-SH CWSLA-Campano Wood Slab	Campano Collection 96" Live-Edge Table [Standing-Height Angled Sleigh Leg] W 96 D 30"-40" H 41.40"	\$11539

IMAGE	CODE	DESCRIPTION	LIST
Coffee Tables 	KOT BLACK, WAL	24"x50" Veneer Coffee Table [15.85" High, Includes 4 Matte Black Legs] W 24" D 50" H 15.85"	\$1462
	KOTD2 BLACK, WAL	24"x50" Veneer Cubby Coffee Table [18" High, Includes 4 Matte Black Legs] W 24" D 50" H 18"	\$2913
Side Tables 	KOTD1 BLACK, WAL	24"x24" Veneer Cubby Side Table [18" High, Includes 4 Matte Black Legs] W 24" D 24" H 18"	\$1392
	KOTS BLACK, WAL	15"x15" Veneer Side Table [22.5" High, Includes 4 Matte Black Legs] W 15" D 15" H 22.5"	\$497



CLEAR
DESIGN
Workspace made easy

