



**Solid storage,  
smart design.**

Our new Stohr collection is crafted from durable metal and comes in five versatile styles to suit any workspace. Add optional cushion seats or a laminate topper for additional seating or just pops of color. Find a storage solution that keeps you looking good while staying organized.

**Statement of Line**

---

**Styles**

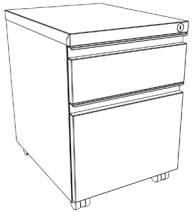

15" Box-Box-File  
Pedestal



15" File-File  
Pedestal

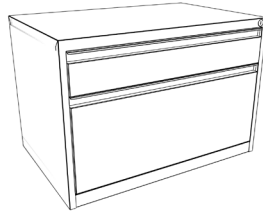

Box-File Lateral

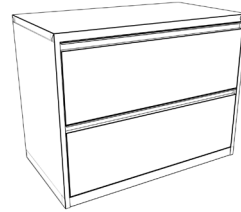

File-File Lateral  
Laminate Topper Available

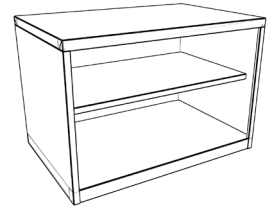

Bookcase  
adjustable shelf

**Options**

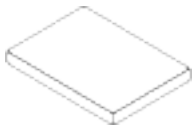

Seat Cushion (Pedestals)  
15"W x 20"D x 1.5"H

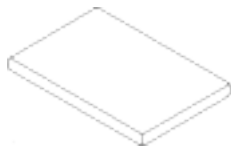

Seat Cushion (Laterals)  
30"W x 20"D x 1.5"H

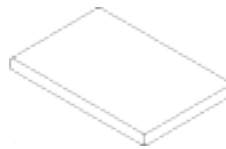

Laminate Topper  
35.5" or 71"W x 20"D x 1"H  
available on Lateral File-File

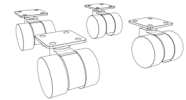

Casters  
set of 4

**Features**

---

- Available in matte powder coated White, Silver, or Black
- Anti-tip counterweights in most styles
- Seat cushions available in 9 colors on our 5-day FAST program
- Laminate Topper available on File File Lateral
- Casters available (set of 4)
- Replacement Lock, Barrel, and Key set available
- Ships fully assembled
- Lifetime Warranty\*

\*Different warranties for laminate and fabric—see our full Warranty card online



**Specifications**

<b>Code</b>	MSBFP
<b>Dimensions</b>	15" W x 20" D x 20" H
<b>Weight</b>	54 lbs
<b>Counterweight</b>	15 lbs
<b>Storage Weight Capacity</b>	Box Drawer: 18 lbs / File Drawer: 30 lbs
<b>Seated weight capacity</b>	200 lbs
<b>Finishes</b>	White, Black, Silver
<b>Options</b>	Cushion Seat
<b>Casters</b>	Installed
<b>Certifications</b>	ANSI/BIFMA X5.5-2014 ISO9001

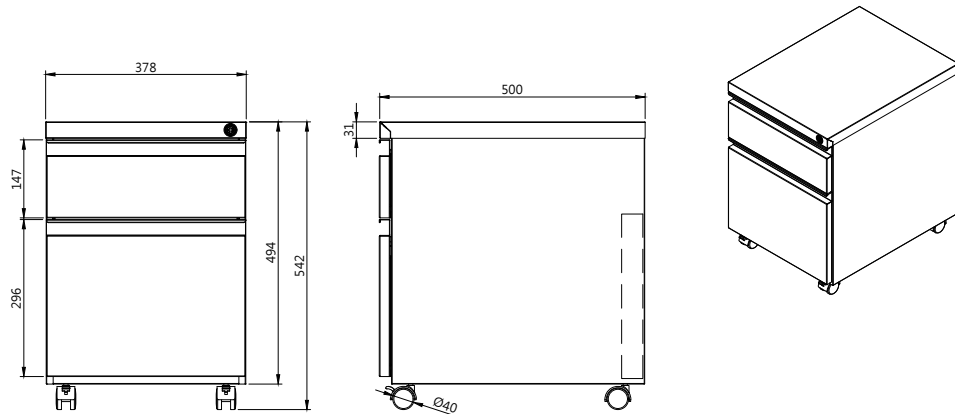



**Specifications**

<b>Code</b>	MSFFP25
<b>Dimensions</b>	15" W x 20" D x 25" H
<b>Weight</b>	72.5 lbs
<b>Counterweight</b>	15 lbs
<b>Storage Weight Capacity</b>	30 lbs each drawer
<b>Seated weight capacity</b>	200 lbs
<b>Options</b>	Cushion Seat, Casters
<b>Finishes</b>	White, Black, Silver
<b>Certifications</b>	ANSI/BIFMA X5.5-2014 ISO9001
<b>Glides</b>	Installed

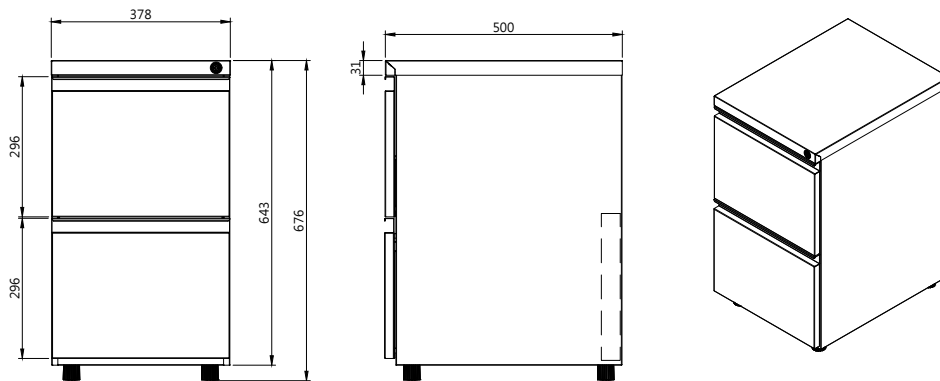



**Specifications**

**Code** MSBKC

**Dimensions** 30" W x 20" D x 20" H

**Weight** 46 lbs

**Counterweight** n/a

**Storage Weight Capacity** Upper Shelf: 35 lbs / Lower Shelf: 50 lbs

**Options** Cushion Seat, Casters

**Finishes** White, Black, Silver

**Glides** Installed

**Shelf** Adjustable

**Certifications** ANSI/BIFMA X5.5-2014  
ISO9001

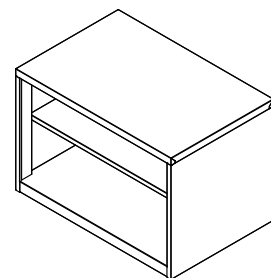
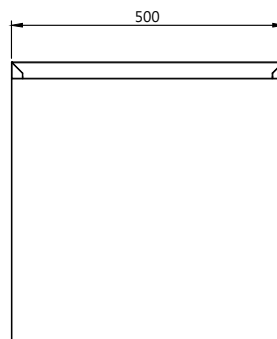
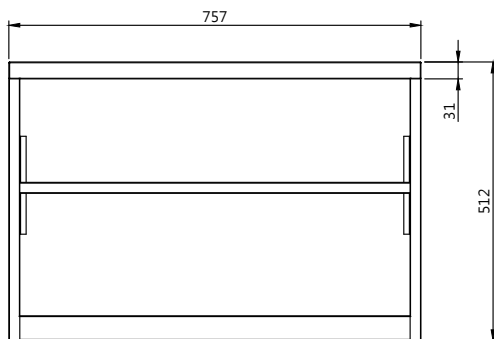

**Specifications**

**Code** MSLBF30

**Dimensions** 30" W x 20" D x 20" H

**Weight** 97 lbs

**Counterweight** 30 lbs

**Storage Weight Capacity** Upper Drawer: 25 lbs / Bottom Drawer: 45 lbs

**Seated Weight Capacity** 200 lbs

**Finishes** White, Black, Silver

**Options** Cushion Seats, Casters

**Certifications** ANSI/BIFMA X5.5-2014  
ISO9001

**Glides** Installed

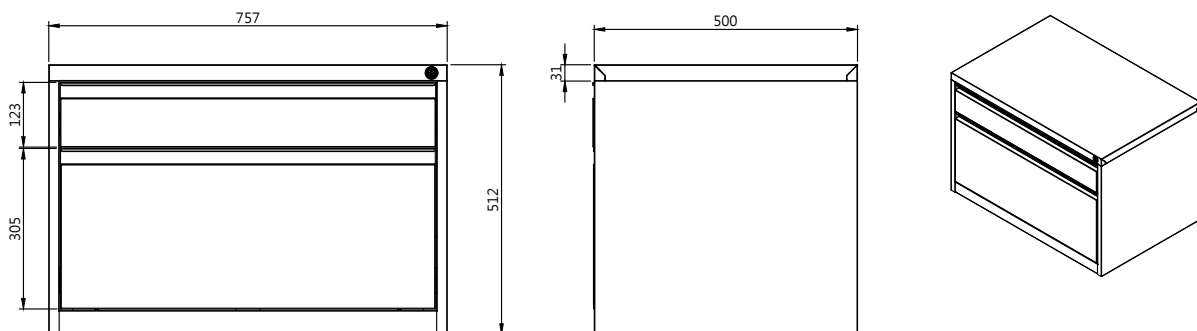



**Specifications**

<b>Code</b>	MSLFF36
<b>Dimensions</b>	36" W x 20" D x 27" H
<b>Weight</b>	130 lbs
<b>Counterweight</b>	30 lbs
<b>Storage Weight Capacity</b>	45 lbs each drawer
<b>Seated weight capacity</b>	200 lbs
<b>Options</b>	Laminate Topper, Casters
<b>Finishes</b>	White, Black, Silver
<b>Glides</b>	Installed
<b>Certifications</b>	ANSI/BIFMA X5.5-2014 ISO9001

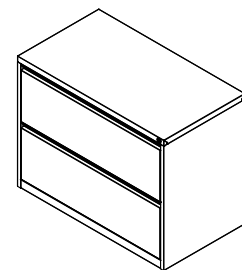
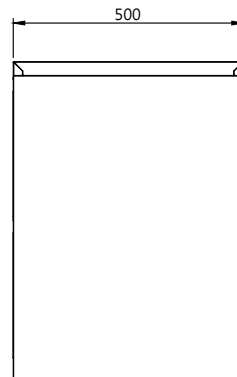
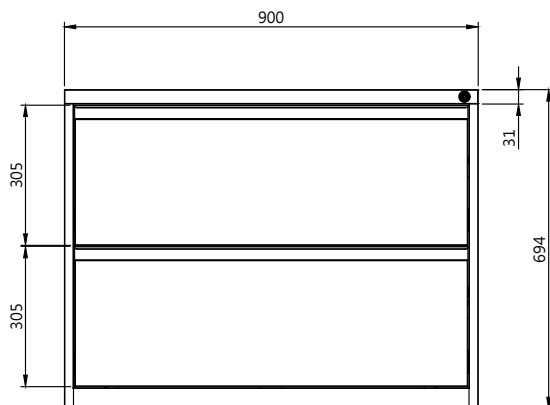

**Materials and Finishes**

**STEEL**



**Black**



**Silver**

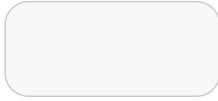

**White**

**FABRIC**



**Carbon (CBN)**

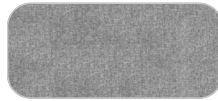

**Alloy (ALY)**



**Luna (LUN)**

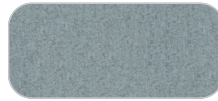

**Harbor (HRB)**



**Fern (FRN)**



**Linen (LIN)**



**Shale (SHL)**



**Canyon (CYN)**



**Terra (TER)**

Fabric not available on FF Lateral

**LAMINATE**

Laminate Topper available on FF Lateral style

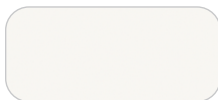

**Electric White (WHT)**



**White Oak (OAK)**

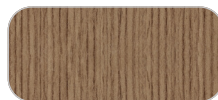

**Sahara Ridge (SAH)**



**Shadow Elm (ELM)**



File-File Lateral style available with Laminate Topper only



**STOHR**

STEEL STORAGE

