

DFH2460-S1

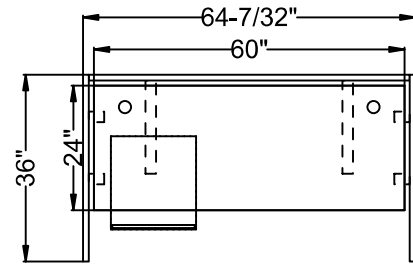

#	Quantity	Part Number	Description	List	Ext. List
Clear Design					
1	2	B12GS33	33" Dry Erase Frosted Glass Divider [13" High]	\$360.00	\$720.00
2	1	B12GS59	59" Dry Erase Frosted Glass Divider [13" High]	\$626.00	\$626.00
3	1	DFRO.4862-K-OAK	Delta Front Panel Floor Modesty, 2-Piece [48x62]	\$1,130.00	\$1,130.00
4	1	DLSB	DELTA Long Structural Support Bracket for Laminate Surfaces, Set of 2	\$251.00	\$251.00
5	2	DSID.4836SI	Delta Side Panel for Side-Side Stations [48x36]	\$747.00	\$1,494.00
6	1	DSSB	DELTA Short Side Support Bracket for Laminate Surfaces, Set of 4	\$171.00	\$171.00
7	1	ELMBF	EDGE Laminate Mobile Box File	\$907.00	\$907.00
8	1	GB2460	24"x60" Surface [1" Thick, Includes 2 Pre-Installed Grommets] - FAST	\$450.00	\$450.00
9	3	PG9	Plastic Gasket for BSB9	\$1.00	\$3.00
10	2	TBRC1830	30" Tackboard with Rounded Corners, Velcro for Mounting	\$172.00	\$344.00
11	1	TBRC1859	59" Tackboard with Rounded Corners, Velcro for Mounting	\$205.00	\$205.00
				Total Clear Design \$6,301.00	

DFH2460-S2

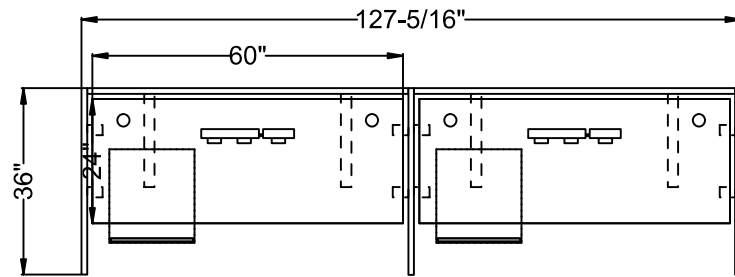

#	Quantity	Part Number	Description	List	Ext. List
Clear Design					
1	3	B12GS33	33" Dry Erase Frosted Glass Divider [13" High]	\$360.00	\$1,080.00
2	2	B12GS59	59" Dry Erase Frosted Glass Divider [13" High]	\$626.00	\$1,252.00
3	2	BWM36	Benching Wire Manager, 36" Wide	\$125.00	\$250.00
4	2	DFHPM	Delta Fixed Height Power Mounting Bracket	\$74.00	\$148.00
5	2	DFRO.4862-K-OAK	Delta Front Panel Floor Modesty, 2-Piece [48x62]	\$1,130.00	\$2,260.00
6	2	DLSB	DELTA Long Structural Support Bracket for Laminate Surfaces, Set of 2	\$251.00	\$502.00
7	3	DSID.4836SI	Delta Side Panel for Side-Side Stations [48x36]	\$747.00	\$2,241.00
8	2	DSSB	DELTA Short Side Support Bracket for Laminate Surfaces, Set of 4	\$171.00	\$342.00
9	2	ELMBF	EDGE Laminate Mobile Box File	\$907.00	\$1,814.00
10	2	GB2460	24"x60" Surface [1" Thick, Includes 2 Pre-Installed Grommets] - FAST	\$450.00	\$900.00
11	5	PG9	Plastic Gasket for BSB9	\$1.00	\$5.00
12	2	PROBC	BOOST Pro In-Line Power Block Connector	\$46.00	\$92.00
13	2	PRODB	BOOST Pro Double Power Block	\$249.00	\$498.00
14	1	PROIF72	BOOST Pro 72" In-feed	\$384.00	\$384.00
15	1	PROJ49	BOOST Pro 49" Jumper	\$277.00	\$277.00
16	2	PROR1	BOOST Pro Duplex Receptacle Circuit 3	\$52.00	\$104.00
17	1	PROR2	BOOST Pro Duplex Receptacle Circuit 1	\$52.00	\$52.00
18	2	PROR3	BOOST Pro Duplex Receptacle Circuit 1	\$52.00	\$104.00
19	1	PROR4	BOOST Pro Duplex Receptacle Circuit 2	\$52.00	\$52.00
20	2	PROSB	BOOST Pro Single Power Block	\$172.00	\$344.00
21	4	TBRC1830	30" Tackboard with Rounded Corners, Velcro for Mounting	\$172.00	\$688.00
22	2	TBRC1859	59" Tackboard with Rounded Corners, Velcro for Mounting	\$205.00	\$410.00
				Total Clear Design	
				\$13,799.00	

DFH2472-S1

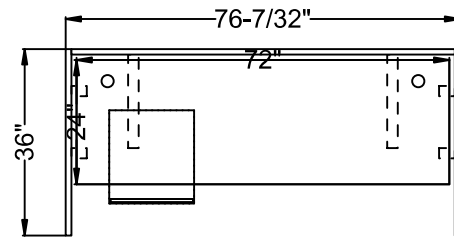

#	Quantity	Part Number	Description	List	Ext. List
Clear Design					
1	2	B12GS33	33" Dry Erase Frosted Glass Divider [13" High]	\$360.00	\$720.00
2	1	B12GS70	71" Dry-Erase Frosted Glass Divider [13" High]	\$748.00	\$748.00
3	1	DFRO.4874-K-OAK	Delta Front Panel Floor Modesty, 2-Piece [48x74]	\$1,254.00	\$1,254.00
4	1	DLSB	DELTA Long Structural Support Bracket for Laminate Surfaces, Set of 2	\$251.00	\$251.00
5	2	DSID.4836SI	Delta Side Panel for Side-Side Stations [48x36]	\$747.00	\$1,494.00
6	1	DSSB	DELTA Short Side Support Bracket for Laminate Surfaces, Set of 4	\$171.00	\$171.00
7	1	ELMBF	EDGE Laminate Mobile Box File	\$907.00	\$907.00
8	1	GB2472	24"x72" Surface [1" Thick, Includes 2 Pre-Installed Grommets] - FAST	\$532.00	\$532.00
9	3	PG9	Plastic Gasket for BSB9	\$1.00	\$3.00
10	2	TBRC1830	30" Tackboard with Rounded Corners, Velcro for Mounting	\$172.00	\$344.00
11	1	TBRC1871	71" Tackboard with Rounded Corners, Velcro for Mounting	\$248.00	\$248.00
				Total Clear Design \$6,672.00	

DFH2472-S2

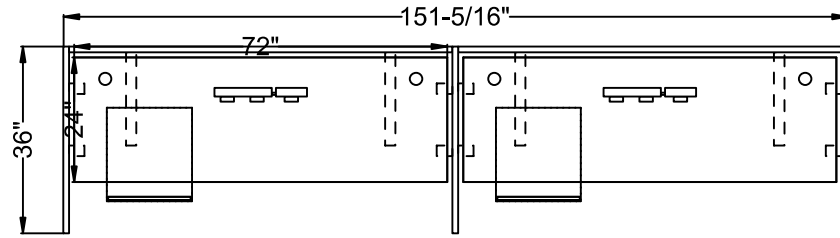

#	Quantity	Part Number	Description	List	Ext. List
Clear Design					
1	3	B12GS33	33" Dry Erase Frosted Glass Divider [13" High]	\$360.00	\$1,080.00
2	2	B12GS70	71" Dry-Erase Frosted Glass Divider [13" High]	\$748.00	\$1,496.00
3	2	BWM36	Benching Wire Manager, 36" Wide	\$125.00	\$250.00
4	2	DFHPM	Delta Fixed Height Power Mounting Bracket	\$74.00	\$148.00
5	2	DFRO.4874-K-OAK	Delta Front Panel Floor Modesty, 2-Piece [48x74]	\$1,254.00	\$2,508.00
6	2	DLSB	DELTA Long Structural Support Bracket for Laminate Surfaces, Set of 2	\$251.00	\$502.00
7	3	DSID.4836SI	Delta Side Panel for Side-Side Stations [48x36]	\$747.00	\$2,241.00
8	2	DSSB	DELTA Short Side Support Bracket for Laminate Surfaces, Set of 4	\$171.00	\$342.00
9	2	ELMBF	EDGE Laminate Mobile Box File	\$907.00	\$1,814.00
10	2	GB2472	24"x72" Surface [1" Thick, Includes 2 Pre-Installed Grommets] - FAST	\$532.00	\$1,064.00
11	5	PG9	Plastic Gasket for BSB9	\$1.00	\$5.00
12	2	PROBC	BOOST Pro In-Line Power Block Connector	\$46.00	\$92.00
13	2	PRODB	BOOST Pro Double Power Block	\$249.00	\$498.00
14	1	PROIF72	BOOST Pro 72" In-feed	\$384.00	\$384.00
15	1	PROJ61	BOOST Pro 61" Jumper	\$326.00	\$326.00
16	1	PROR1	BOOST Pro Duplex Receptacle Circuit 3	\$52.00	\$52.00
17	1	PROR2	BOOST Pro Duplex Receptacle, Controlled, Circuit 4	\$52.00	\$52.00
18	2	PROR3	BOOST Pro Duplex Receptacle Circuit 1	\$52.00	\$104.00
19	2	PROR4	BOOST Pro Duplex Receptacle Circuit 2	\$52.00	\$104.00
20	2	PROSB	BOOST Pro Single Power Block	\$172.00	\$344.00
21	4	TBRC1830	30" Tackboard with Rounded Corners, Velcro for Mounting	\$172.00	\$688.00
22	2	TBRC1871	71" Tackboard with Rounded Corners, Velcro for Mounting	\$248.00	\$496.00
				Total Clear Design \$14,590.00	

DFH3060-S1

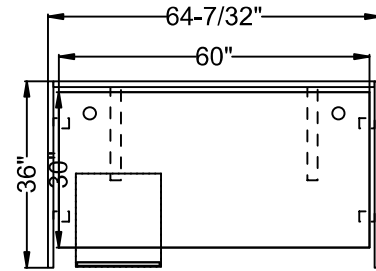

#	Quantity	Part Number	Description	List	Ext. List
Clear Design					
1	2	B12GS33	33" Dry Erase Frosted Glass Divider [13" High]	\$360.00	\$720.00
2	1	B12GS59	59" Dry Erase Frosted Glass Divider [13" High]	\$626.00	\$626.00
3	1	DFRO.4862-K-OAK	Delta Front Panel Floor Modesty, 2-Piece [48x62]	\$1,130.00	\$1,130.00
4	1	DLSB	DELTA Long Structural Support Bracket for Laminate Surfaces, Set of 2	\$251.00	\$251.00
5	2	DSID.4836SI	Delta Side Panel for Side-Side Stations [48x36]	\$747.00	\$1,494.00
6	1	DSSB	DELTA Short Side Support Bracket for Laminate Surfaces, Set of 4	\$171.00	\$171.00
7	1	ELMBF	EDGE Laminate Mobile Box File	\$907.00	\$907.00
8	1	GB3060	30"x60" Surface [1" Thick, Includes 2 Pre-Installed Grommets] - FAST	\$575.00	\$575.00
9	3	PG9	Plastic Gasket for BSB9	\$1.00	\$3.00
10	2	TBRC1830	30" Tackboard with Rounded Corners, Velcro for Mounting	\$172.00	\$344.00
11	1	TBRC1859	59" Tackboard with Rounded Corners, Velcro for Mounting	\$205.00	\$205.00
				Total Clear Design \$6,426.00	

DFH3060-S2

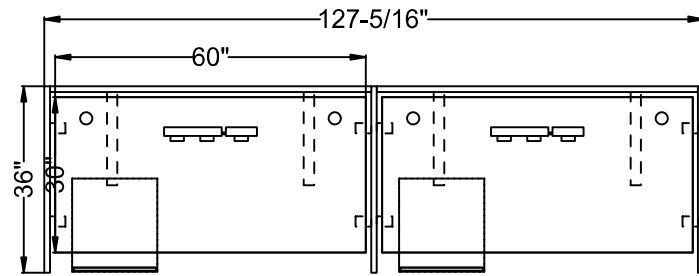

#	Quantity	Part Number	Description	List	Ext. List
Clear Design					
1	3	B12GS33	33" Dry Erase Frosted Glass Divider [13" High]	\$360.00	\$1,080.00
2	2	B12GS59	59" Dry Erase Frosted Glass Divider [13" High]	\$626.00	\$1,252.00
3	2	BWM36	Benching Wire Manager, 36" Wide	\$125.00	\$250.00
4	2	DFHPM	Delta Fixed Height Power Mounting Bracket	\$74.00	\$148.00
5	2	DFRO.4862-K-OAK	Delta Front Panel Floor Modesty, 2-Piece [48x62]	\$1,130.00	\$2,260.00
6	2	DLSB	DELTA Long Structural Support Bracket for Laminate Surfaces, Set of 2	\$251.00	\$502.00
7	3	DSID.4836SI	Delta Side Panel for Side-Side Stations [48x36]	\$747.00	\$2,241.00
8	2	DSSB	DELTA Short Side Support Bracket for Laminate Surfaces, Set of 4	\$171.00	\$342.00
9	2	ELMBF	EDGE Laminate Mobile Box File	\$907.00	\$1,814.00
10	2	GB3060	30"x60" Surface [1" Thick, Includes 2 Pre-Installed Grommets] - FAST	\$575.00	\$1,150.00
11	5	PG9	Plastic Gasket for BSB9	\$1.00	\$5.00
12	2	PROBC	BOOST Pro In-Line Power Block Connector	\$46.00	\$92.00
13	2	PRODB	BOOST Pro Double Power Block	\$249.00	\$498.00
14	1	PROIF72	BOOST Pro 72" In-feed	\$384.00	\$384.00
15	1	PROJ49	BOOST Pro 49" Jumper	\$277.00	\$277.00
16	2	PROR1	BOOST Pro Duplex Receptacle Circuit 2	\$52.00	\$104.00
17	1	PROR2	BOOST Pro Duplex Receptacle Circuit 2	\$52.00	\$52.00
18	2	PROR3	BOOST Pro Duplex Receptacle, Controlled, Circuit 4	\$52.00	\$104.00
19	1	PROR4	BOOST Pro Duplex Receptacle Circuit 1	\$52.00	\$52.00
20	2	PROSB	BOOST Pro Single Power Block	\$172.00	\$344.00
21	4	TBRC1830	30" Tackboard with Rounded Corners, Velcro for Mounting	\$172.00	\$688.00
22	2	TBRC1859	59" Tackboard with Rounded Corners, Velcro for Mounting	\$205.00	\$410.00
				Total Clear Design	\$14,049.00

DFH3072-S1

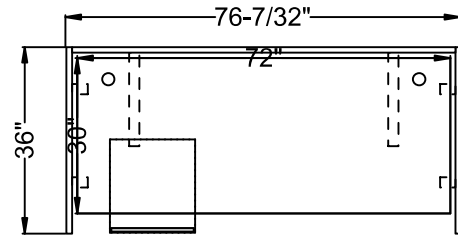

#	Quantity	Part Number	Description	List	Ext. List
Clear Design					
1	2	B12GS33	33" Dry Erase Frosted Glass Divider [13" High]	\$360.00	\$720.00
2	1	B12GS70	71" Dry-Erase Frosted Glass Divider [13" High]	\$748.00	\$748.00
3	1	DFRO.4874-K-OAK	Delta Front Panel Floor Modesty, 2-Piece [48x74]	\$1,254.00	\$1,254.00
4	1	DLSB	DELTA Long Structural Support Bracket for Laminate Surfaces, Set of 2	\$251.00	\$251.00
5	2	DSID.4836SI	Delta Side Panel for Side-Side Stations [48x36]	\$747.00	\$1,494.00
6	1	DSSB	DELTA Short Side Support Bracket for Laminate Surfaces, Set of 4	\$171.00	\$171.00
7	1	ELMBF	EDGE Laminate Mobile Box File	\$907.00	\$907.00
8	1	GB3072	30"x72" Surface [1" Thick, Includes 2 Pre-Installed Grommets] - FAST	\$660.00	\$660.00
9	3	PG9	Plastic Gasket for BSB9	\$1.00	\$3.00
10	2	TBRC1830	30" Tackboard with Rounded Corners, Velcro for Mounting	\$172.00	\$344.00
11	1	TBRC1871	71" Tackboard with Rounded Corners, Velcro for Mounting	\$248.00	\$248.00
				Total Clear Design	\$6,800.00

DFH3072-S2

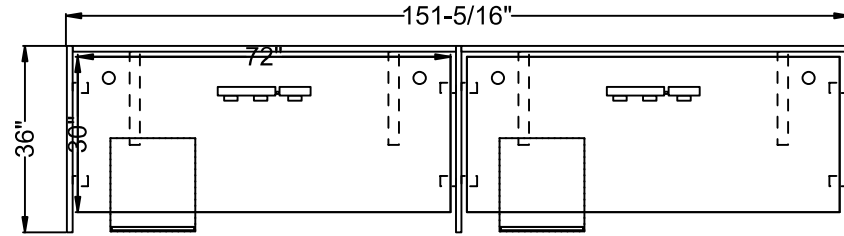

#	Quantity	Part Number	Description	List	Ext. List
Clear Design					
1	3	B12GS33	33" Dry Erase Frosted Glass Divider [13" High]	\$360.00	\$1,080.00
2	2	B12GS70	71" Dry-Erase Frosted Glass Divider [13" High]	\$748.00	\$1,496.00
3	2	BWM36	Benching Wire Manager, 36" Wide	\$125.00	\$250.00
4	2	DFHPM	Delta Fixed Height Power Mounting Bracket	\$74.00	\$148.00
5	2	DFRO.4874-K-OAK	Delta Front Panel Floor Modesty, 2-Piece [48x74]	\$1,254.00	\$2,508.00
6	2	DLSB	DELTA Long Structural Support Bracket for Laminate Surfaces, Set of 2	\$251.00	\$502.00
7	3	DSID.4836SI	Delta Side Panel for Side-Side Stations [48x36]	\$747.00	\$2,241.00
8	2	DSSB	DELTA Short Side Support Bracket for Laminate Surfaces, Set of 4	\$171.00	\$342.00
9	2	ELMBF	EDGE Laminate Mobile Box File	\$907.00	\$1,814.00
10	2	GB3072	30"x72" Surface [1" Thick, Includes 2 Pre-Installed Grommets] - FAST	\$660.00	\$1,320.00
11	5	PG9	Plastic Gasket for BSB9	\$1.00	\$5.00
12	2	PROBC	BOOST Pro In-Line Power Block Connector	\$46.00	\$92.00
13	2	PRODB	BOOST Pro Double Power Block	\$249.00	\$498.00
14	1	PROIF72	BOOST Pro 72" In-feed	\$384.00	\$384.00
15	1	PROJ61	BOOST Pro 61" Jumper	\$326.00	\$326.00
16	2	PROR1	BOOST Pro Duplex Receptacle Circuit 1	\$52.00	\$104.00
17	2	PROR2	BOOST Pro Duplex Receptacle Circuit 2	\$52.00	\$104.00
18	2	PROR3	BOOST Pro Duplex Receptacle Circuit 3	\$52.00	\$104.00
19	2	PROSB	BOOST Pro Single Power Block	\$172.00	\$344.00
20	4	TBRC1830	30" Tackboard with Rounded Corners, Velcro for Mounting	\$172.00	\$688.00
21	2	TBRC1871	71" Tackboard with Rounded Corners, Velcro for Mounting	\$248.00	\$496.00

Total Clear Design \$14,846.00

DFHM2460R2448-S1

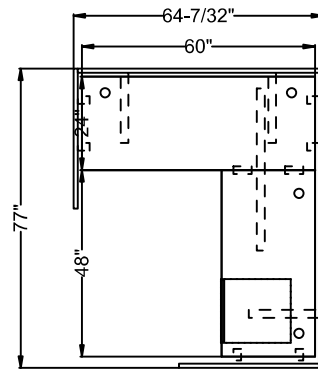

#	Quantity	Part Number	Description	List	Ext. List
Clear Design					
1	2	B12GS33	33" Dry Erase Frosted Glass Divider [13" High]	\$360.00	\$720.00
2	1	B12GS59	59" Dry Erase Frosted Glass Divider [13" High]	\$626.00	\$626.00
3	1	B12GS74	74" Dry Erase Frosted Glass Divider [13" High]	\$748.00	\$748.00
4	1	BASB72	42" Support Bar	\$173.00	\$173.00
5	2	BFB1	Flat Bracket	\$8.00	\$16.00
6	1	DEND.4836	Delta End Panel for Return Leg [48x36]	\$747.00	\$747.00
7	1	DFRO.4862-K-OAK	Delta Front Panel Floor Modesty, 2-Piece [48x62]	\$1,130.00	\$1,130.00
8	2	DLSB	DELTA Long Structural Support Bracket for Laminate Surfaces, Set of 2	\$251.00	\$502.00
9	1	DRET.4877SI-K-OAK	Delta Return Panel for Side-Side Stations, 2-Piece [48x77]	\$1,372.00	\$1,372.00
10	1	DSID.4836SI	Delta Side Panel for Side-Side Stations [48x36]	\$747.00	\$747.00
11	2	DSSB	DELTA Short Side Support Bracket for Laminate Surfaces, Set of 4	\$171.00	\$342.00
12	1	ELMBF	EDGE Laminate Mobile Box File	\$907.00	\$907.00
13	1	GB2448	24"x48" Surface [1" Thick, Includes 2 Pre-Installed Grommets] - FAST	\$363.00	\$363.00
14	1	GB2460	24"x60" Surface [1" Thick, Includes 2 Pre-Installed Grommets] - FAST	\$450.00	\$450.00
15	4	PG9	Plastic Gasket for BSB9	\$1.00	\$4.00
16	1	TBRC1830	30" Tackboard with Rounded Corners, Velcro for Mounting	\$172.00	\$172.00
17	1	TBRC1859	59" Tackboard with Rounded Corners, Velcro for Mounting	\$205.00	\$205.00
18	1	TBRC1871	71" Tackboard with Rounded Corners, Velcro for Mounting	\$248.00	\$248.00

Total Clear Design \$9,472.00

DFHM2460R2448-S2

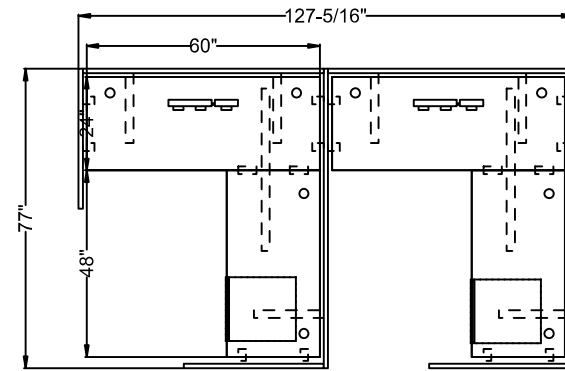

#	Quantity	Part Number	Description	List	Ext. List
Clear Design					
1	3	B12GS33	33" Dry Erase Frosted Glass Divider [13" High]	\$360.00	\$1,080.00
2	2	B12GS59	59" Dry Erase Frosted Glass Divider [13" High]	\$626.00	\$1,252.00
3	2	B12GS74	74" Dry Erase Frosted Glass Divider [13" High]	\$748.00	\$1,496.00
4	2	BASB72	42" Support Bar	\$173.00	\$346.00
5	4	BFB1	Flat Bracket	\$8.00	\$32.00
6	2	BWM36	Benching Wire Manager, 36" Wide	\$125.00	\$250.00
7	2	DEND.4836	Delta End Panel for Return Leg [48x36]	\$747.00	\$1,494.00
8	2	DFHPM	Delta Fixed Height Power Mounting Bracket	\$74.00	\$148.00
9	2	DFRO.4862-K-OAK	Delta Front Panel Floor Modesty, 2-Piece [48x62]	\$1,130.00	\$2,260.00
10	3	DLSB	DELTA Long Structural Support Bracket for Laminate Surfaces, Set of 2	\$251.00	\$753.00
11	2	DRET.4877SI-K-OAK	Delta Return Panel for Side-Side Stations, 2-Piece [48x77]	\$1,372.00	\$2,744.00
12	1	DSID.4836SI	Delta Side Panel for Side-Side Stations [48x36]	\$747.00	\$747.00
13	3	DSSB	DELTA Short Side Support Bracket for Laminate Surfaces, Set of 4	\$171.00	\$513.00
14	2	ELMBF	EDGE Laminate Mobile Box File	\$907.00	\$1,814.00
15	2	GB2448	24"x48" Surface [1" Thick, Includes 2 Pre-Installed Grommets] - FAST	\$363.00	\$726.00
16	2	GB2460	24"x60" Surface [1" Thick, Includes 2 Pre-Installed Grommets] - FAST	\$450.00	\$900.00
17	7	PG9	Plastic Gasket for BSB9	\$1.00	\$7.00
18	2	PROBC	BOOST Pro In-Line Power Block Connector	\$46.00	\$92.00
19	2	PRODB	BOOST Pro Double Power Block	\$249.00	\$498.00
20	1	PROIF72	BOOST Pro 72" In-feed	\$384.00	\$384.00
21	1	PROJ49	BOOST Pro 49" Jumper	\$277.00	\$277.00
22	2	PROR1	BOOST Pro Duplex Receptacle Circuit 1	\$52.00	\$104.00
23	2	PROR2	BOOST Pro Duplex Receptacle Circuit 2	\$52.00	\$104.00
24	1	PROR3	BOOST Pro Duplex Receptacle Circuit 3	\$52.00	\$52.00
25	1	PROR4	BOOST Pro Duplex Receptacle, Controlled, Circuit 4	\$52.00	\$52.00
26	2	PROSB	BOOST Pro Single Power Block	\$172.00	\$344.00
27	1	TBRC1830	30" Tackboard with Rounded Corners, Velcro for Mounting	\$172.00	\$172.00
28	2	TBRC1859	59" Tackboard with Rounded Corners, Velcro for Mounting	\$205.00	\$410.00
29	3	TBRC1871	71" Tackboard with Rounded Corners, Velcro for Mounting	\$248.00	\$744.00
				Total Clear Design \$19,795.00	

DFHM2472R2448-S1

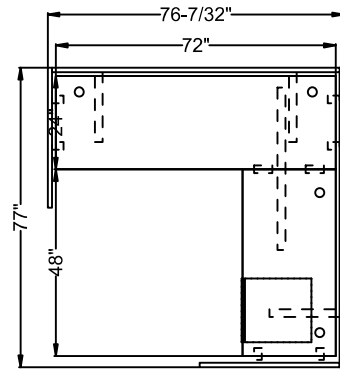

#	Quantity	Part Number	Description	List	Ext. List
Clear Design					
1	2	B12GS33	33" Dry Erase Frosted Glass Divider [13" High]	\$360.00	\$720.00
2	1	B12GS70	71" Dry-Erase Frosted Glass Divider [13" High]	\$748.00	\$748.00
3	1	B12GS74	74" Dry Erase Frosted Glass Divider [13" High]	\$748.00	\$748.00
4	1	BASB72	42" Support Bar	\$173.00	\$173.00
5	2	BFB1	Flat Bracket	\$8.00	\$16.00
6	1	DEND.4836	Delta End Panel for Return Leg [48x36]	\$747.00	\$747.00
7	1	DFRO.4874-K-OAK	Delta Front Panel Floor Modesty, 2-Piece [48x74]	\$1,254.00	\$1,254.00
8	2	DLSB	DELTA Long Structural Support Bracket for Laminate Surfaces, Set of 2	\$251.00	\$502.00
9	1	DRET.4877SI-K-OAK	Delta Return Panel for Side-Side Stations, 2-Piece [48x77]	\$1,372.00	\$1,372.00
10	1	DSID.4836SI	Delta Side Panel for Side-Side Stations [48x36]	\$747.00	\$747.00
11	2	DSSB	DELTA Short Side Support Bracket for Laminate Surfaces, Set of 4	\$171.00	\$342.00
12	1	ELMBF	EDGE Laminate Mobile Box File	\$907.00	\$907.00
13	1	GB2448	24"x48" Surface [1" Thick, Includes 2 Pre-Installed Grommets] - FAST	\$363.00	\$363.00
14	1	GB2472	24"x72" Surface [1" Thick, Includes 2 Pre-Installed Grommets] - FAST	\$532.00	\$532.00
15	4	PG9	Plastic Gasket for BSB9	\$1.00	\$4.00
16	1	TBRC1830	30" Tackboard with Rounded Corners, Velcro for Mounting	\$172.00	\$172.00
17	2	TBRC1871	71" Tackboard with Rounded Corners, Velcro for Mounting	\$248.00	\$496.00
				Total Clear Design \$9,843.00	

DFHM2472R2448-S2

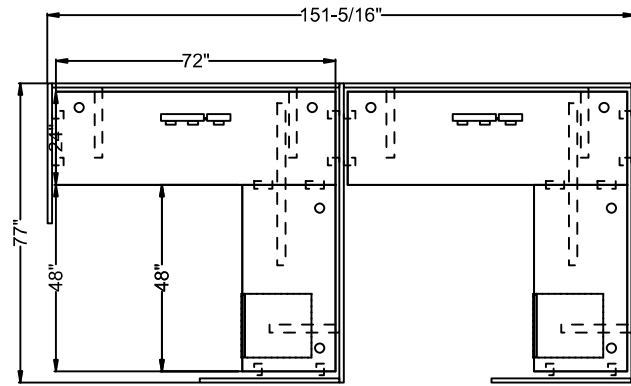

#	Quantity	Part Number	Description	List	Ext. List
Clear Design					
1	3	B12GS33	33" Dry Erase Frosted Glass Divider [13" High]	\$360.00	\$1,080.00
2	2	B12GS70	71" Dry-Erase Frosted Glass Divider [13" High]	\$748.00	\$1,496.00
3	2	B12GS74	74" Dry Erase Frosted Glass Divider [13" High]	\$748.00	\$1,496.00
4	2	BASB72	42" Support Bar	\$173.00	\$346.00
5	4	BFB1	Flat Bracket	\$8.00	\$32.00
6	2	BWM36	Benching Wire Manager, 36" Wide	\$125.00	\$250.00
7	2	DEND.4836	Delta End Panel for Return Leg [48x36]	\$747.00	\$1,494.00
8	2	DFHPM	Delta Fixed Height Power Mounting Bracket	\$74.00	\$148.00
9	2	DFRO.4874-K-OAK	Delta Front Panel Floor Modesty, 2-Piece [48x74]	\$1,254.00	\$2,508.00
10	3	DLSB	DELTA Long Structural Support Bracket for Laminate Surfaces, Set of 2	\$251.00	\$753.00
11	2	DRET.4877SI-K-OAK	Delta Return Panel for Side-Side Stations, 2-Piece [48x77]	\$1,372.00	\$2,744.00
12	1	DSID.4836SI	Delta Side Panel for Side-Side Stations [48x36]	\$747.00	\$747.00
13	3	DSSB	DELTA Short Side Support Bracket for Laminate Surfaces, Set of 4	\$171.00	\$513.00
14	2	ELMBF	EDGE Laminate Mobile Box File	\$907.00	\$1,814.00
15	2	GB2448	24"x48" Surface [1" Thick, Includes 2 Pre-Installed Grommets] - FAST	\$363.00	\$726.00
16	2	GB2472	24"x72" Surface [1" Thick, Includes 2 Pre-Installed Grommets] - FAST	\$532.00	\$1,064.00
17	7	PG9	Plastic Gasket for BSB9	\$1.00	\$7.00
18	2	PROBC	BOOST Pro In-Line Power Block Connector	\$46.00	\$92.00
19	2	PRODB	BOOST Pro Double Power Block	\$249.00	\$498.00
20	1	PROIF72	BOOST Pro 72" In-feed	\$384.00	\$384.00
21	1	PROJ61	BOOST Pro 61" Jumper	\$326.00	\$326.00
22	1	PROR1	BOOST Pro Duplex Receptacle Circuit 1	\$52.00	\$52.00
23	2	PROR2	BOOST Pro Duplex Receptacle Circuit 1	\$52.00	\$104.00
24	1	PROR3	BOOST Pro Duplex Receptacle Circuit 2	\$52.00	\$52.00
25	2	PROR4	BOOST Pro Duplex Receptacle Circuit 3	\$52.00	\$104.00
26	2	PROSB	BOOST Pro Single Power Block	\$172.00	\$344.00
27	1	TBRC1830	30" Tackboard with Rounded Corners, Velcro for Mounting	\$172.00	\$172.00
28	5	TBRC1871	71" Tackboard with Rounded Corners, Velcro for Mounting	\$248.00	\$1,240.00

Total Clear Design \$20,586.00

DFHM3060R2442-S1

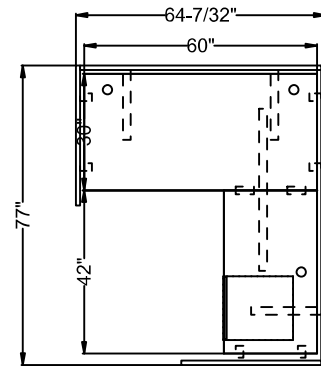

#	Quantity	Part Number	Description	List	Ext. List
Clear Design					
1	2	B12GS33	33" Dry Erase Frosted Glass Divider [13" High]	\$360.00	\$720.00
2	1	B12GS59	59" Dry Erase Frosted Glass Divider [13" High]	\$626.00	\$626.00
3	1	B12GS74	74" Dry Erase Frosted Glass Divider [13" High]	\$748.00	\$748.00
4	1	BASB72	42" Support Bar	\$173.00	\$173.00
5	2	BFB1	Flat Bracket	\$8.00	\$16.00
6	1	DEND.4836	Delta End Panel for Return Leg [48x36]	\$747.00	\$747.00
7	1	DFRO.4862-K-OAK	Delta Front Panel Floor Modesty, 2-Piece [48x62]	\$1,130.00	\$1,130.00
8	2	DLSB	DELTA Long Structural Support Bracket for Laminate Surfaces, Set of 2	\$251.00	\$502.00
9	1	DRET.4877SI-K-OAK	Delta Return Panel for Side-Side Stations, 2-Piece [48x77]	\$1,372.00	\$1,372.00
10	1	DSID.4836SI	Delta Side Panel for Side-Side Stations [48x36]	\$747.00	\$747.00
11	2	DSSB	DELTA Short Side Support Bracket for Laminate Surfaces, Set of 4	\$171.00	\$342.00
12	1	ELMBF	EDGE Laminate Mobile Box File	\$907.00	\$907.00
13	1	GB2442	24"x42" Cross-Grain Surface [1" Thick, Includes 1 Pre-Installed Grommet] - FAST	\$317.00	\$317.00
14	1	GB3060	30"x60" Surface [1" Thick, Includes 2 Pre-Installed Grommets] - FAST	\$575.00	\$575.00
15	4	PG9	Plastic Gasket for BSB9	\$1.00	\$4.00
16	1	TBRC1830	30" Tackboard with Rounded Corners, Velcro for Mounting	\$172.00	\$172.00
17	1	TBRC1859	59" Tackboard with Rounded Corners, Velcro for Mounting	\$205.00	\$205.00
18	1	TBRC1871	71" Tackboard with Rounded Corners, Velcro for Mounting	\$248.00	\$248.00
				Total Clear Design \$9,551.00	

DFHM3060R2442-S2

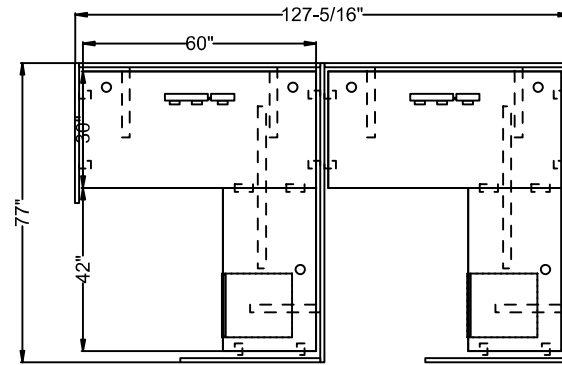

#	Quantity	Part Number	Description	List	Ext. List
Clear Design					
1	3	B12GS33	33" Dry Erase Frosted Glass Divider [13" High]	\$360.00	\$1,080.00
2	2	B12GS59	59" Dry Erase Frosted Glass Divider [13" High]	\$626.00	\$1,252.00
3	2	B12GS74	74" Dry Erase Frosted Glass Divider [13" High]	\$748.00	\$1,496.00
4	2	BASB72	42" Support Bar	\$173.00	\$346.00
5	4	BFB1	Flat Bracket	\$8.00	\$32.00
6	2	BWM36	Benching Wire Manager, 36" Wide	\$125.00	\$250.00
7	2	DEND.4836	Delta End Panel for Return Leg [48x36]	\$747.00	\$1,494.00
8	2	DFHPM	Delta Fixed Height Power Mounting Bracket	\$74.00	\$148.00
9	2	DFRO.4862-K-OAK	Delta Front Panel Floor Modesty, 2-Piece [48x62]	\$1,130.00	\$2,260.00
10	3	DLSB	DELTA Long Structural Support Bracket for Laminate Surfaces, Set of 2	\$251.00	\$753.00
11	2	DRET.4877SI-K-OAK	Delta Return Panel for Side-Side Stations, 2-Piece [48x77]	\$1,372.00	\$2,744.00
12	1	DSID.4836SI	Delta Side Panel for Side-Side Stations [48x36]	\$747.00	\$747.00
13	3	DSSB	DELTA Short Side Support Bracket for Laminate Surfaces, Set of 4	\$171.00	\$513.00
14	2	ELMBF	EDGE Laminate Mobile Box File	\$907.00	\$1,814.00
15	2	GB2442	24"x42" Cross-Grain Surface [1" Thick, Includes 1 Pre-Installed Grommet] - FAST	\$317.00	\$634.00
16	2	GB3060	30"x60" Surface [1" Thick, Includes 2 Pre-Installed Grommets] - FAST	\$575.00	\$1,150.00
17	7	PG9	Plastic Gasket for BSB9	\$1.00	\$7.00
18	2	PROBC	BOOST Pro In-Line Power Block Connector	\$46.00	\$92.00
19	2	PRODB	BOOST Pro Double Power Block	\$249.00	\$498.00
20	1	PROIF72	BOOST Pro 72" In-feed	\$384.00	\$384.00
21	1	PROJ49	BOOST Pro 49" Jumper	\$277.00	\$277.00
22	2	PROR1	BOOST Pro Duplex Receptacle Circuit 1	\$52.00	\$104.00
23	2	PROR2	BOOST Pro Duplex Receptacle Circuit 2	\$52.00	\$104.00
24	2	PROR3	BOOST Pro Duplex Receptacle Circuit 3	\$52.00	\$104.00
25	2	PROSB	BOOST Pro Single Power Block	\$172.00	\$344.00
26	1	TBRC1830	30" Tackboard with Rounded Corners, Velcro for Mounting	\$172.00	\$172.00
27	2	TBRC1859	59" Tackboard with Rounded Corners, Velcro for Mounting	\$205.00	\$410.00
28	3	TBRC1871	71" Tackboard with Rounded Corners, Velcro for Mounting	\$248.00	\$744.00

Total Clear Design \$19,953.00

DFHM3072R2442-S1

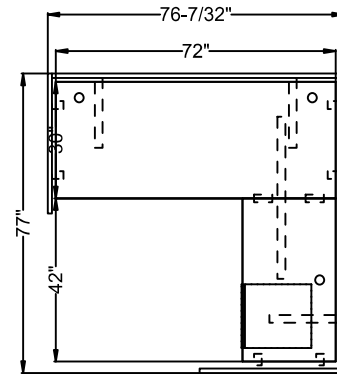

#	Quantity	Part Number	Description	List	Ext. List
Clear Design					
1	2	B12GS33	33" Dry Erase Frosted Glass Divider [13" High]	\$360.00	\$720.00
2	1	B12GS70	71" Dry-Erase Frosted Glass Divider [13" High]	\$748.00	\$748.00
3	1	B12GS74	74" Dry Erase Frosted Glass Divider [13" High]	\$748.00	\$748.00
4	1	BASB72	42" Support Bar	\$173.00	\$173.00
5	2	BFB1	Flat Bracket	\$8.00	\$16.00
6	1	DEND.4836	Delta End Panel for Return Leg [48x36]	\$747.00	\$747.00
7	1	DFRO.4874-K-OAK	Delta Front Panel Floor Modesty, 2-Piece [48x74]	\$1,254.00	\$1,254.00
8	2	DLSB	DELTA Long Structural Support Bracket for Laminate Surfaces, Set of 2	\$251.00	\$502.00
9	1	DRET.4877SI-K-OAK	Delta Return Panel for Side-Side Stations, 2-Piece [48x77]	\$1,372.00	\$1,372.00
10	1	DSID.4836SI	Delta Side Panel for Side-Side Stations [48x36]	\$747.00	\$747.00
11	2	DSSB	DELTA Short Side Support Bracket for Laminate Surfaces, Set of 4	\$171.00	\$342.00
12	1	ELMBF	EDGE Laminate Mobile Box File	\$907.00	\$907.00
13	1	GB2442	24"x42" Cross-Grain Surface [1" Thick, Includes 1 Pre-Installed Grommet] - FAST	\$317.00	\$317.00
14	1	GB3072	30"x72" Surface [1" Thick, Includes 2 Pre-Installed Grommets] - FAST	\$660.00	\$660.00
15	4	PG9	Plastic Gasket for BSB9	\$1.00	\$4.00
16	1	TBRC1830	30" Tackboard with Rounded Corners, Velcro for Mounting	\$172.00	\$172.00
17	2	TBRC1871	71" Tackboard with Rounded Corners, Velcro for Mounting	\$248.00	\$496.00
				Total Clear Design \$9,925.00	

DFHM3072R2442-S2

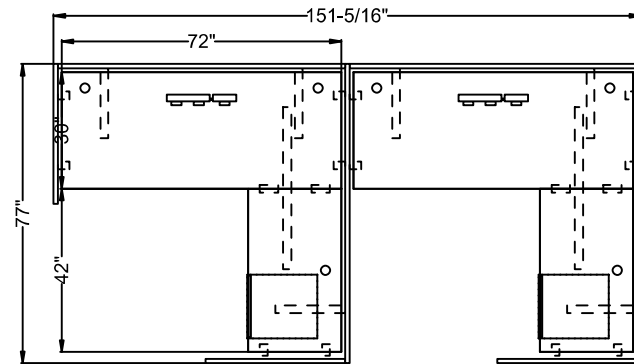

#	Quantity	Part Number	Description	List	Ext. List
Clear Design					
1	3	B12GS33	33" Dry Erase Frosted Glass Divider [13" High]	\$360.00	\$1,080.00
2	2	B12GS70	71" Dry-Erase Frosted Glass Divider [13" High]	\$748.00	\$1,496.00
3	2	B12GS74	74" Dry Erase Frosted Glass Divider [13" High]	\$748.00	\$1,496.00
4	2	BASB72	42" Support Bar	\$173.00	\$346.00
5	4	BFB1	Flat Bracket	\$8.00	\$32.00
6	2	BWM36	Benching Wire Manager, 36" Wide	\$125.00	\$250.00
7	2	DEND.4836	Delta End Panel for Return Leg [48x36]	\$747.00	\$1,494.00
8	2	DFHPM	Delta Fixed Height Power Mounting Bracket	\$74.00	\$148.00
9	2	DFRO.4874-K-OAK	Delta Front Panel Floor Modesty, 2-Piece [48x74]	\$1,254.00	\$2,508.00
10	3	DLSB	DELTA Long Structural Support Bracket for Laminate Surfaces, Set of 2	\$251.00	\$753.00
11	2	DRET.4877SI-K-OAK	Delta Return Panel for Side-Side Stations, 2-Piece [48x77]	\$1,372.00	\$2,744.00
12	1	DSID.4836SI	Delta Side Panel for Side-Side Stations [48x36]	\$747.00	\$747.00
13	3	DSSB	DELTA Short Side Support Bracket for Laminate Surfaces, Set of 4	\$171.00	\$513.00
14	2	ELMBF	EDGE Laminate Mobile Box File	\$907.00	\$1,814.00
15	2	GB2442	24"x42" Cross-Grain Surface [1" Thick, Includes 1 Pre-Installed Grommet] - FAST	\$317.00	\$634.00
16	2	GB3072	30"x72" Surface [1" Thick, Includes 2 Pre-Installed Grommets] - FAST	\$660.00	\$1,320.00
17	7	PG9	Plastic Gasket for BSB9	\$1.00	\$7.00
18	2	PROBC	BOOST Pro In-Line Power Block Connector	\$46.00	\$92.00
19	2	PRODB	BOOST Pro Double Power Block	\$249.00	\$498.00
20	1	PROIF72	BOOST Pro 72" In-feed	\$384.00	\$384.00
21	1	PROJ61	BOOST Pro 61" Jumper	\$326.00	\$326.00
22	2	PROR1	BOOST Pro Duplex Receptacle Circuit 1	\$52.00	\$104.00
23	2	PROR2	BOOST Pro Duplex Receptacle Circuit 2	\$52.00	\$104.00
24	2	PROR4	BOOST Pro Duplex Receptacle, Controlled, Circuit 4	\$52.00	\$104.00
25	2	PROSB	BOOST Pro Single Power Block	\$172.00	\$344.00
26	1	TBRC1830	30" Tackboard with Rounded Corners, Velcro for Mounting	\$172.00	\$172.00
27	5	TBRC1871	71" Tackboard with Rounded Corners, Velcro for Mounting	\$248.00	\$1,240.00
				Total Clear Design \$20,750.00	

DFH2460-F2

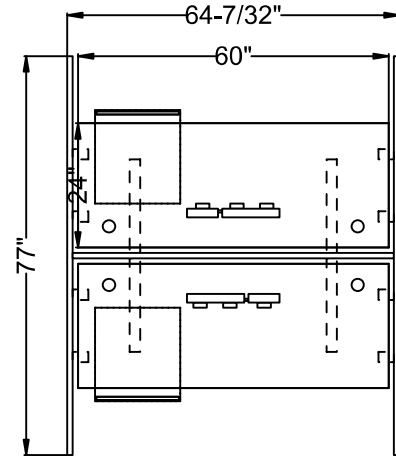

#	Quantity	Part Number	Description	List	Ext. List
Clear Design					
1	1	B12GS59	59" Dry Erase Frosted Glass Divider [13" High]	\$626.00	\$626.00
2	2	B12GS74	74" Dry Erase Frosted Glass Divider [13" High]	\$748.00	\$1,496.00
3	2	BWM36	Benching Wire Manager, 36" Wide	\$125.00	\$250.00
4	2	DFHPM	Delta Fixed Height Power Mounting Bracket	\$74.00	\$148.00
5	1	DFRO.4862-K-OAK	Delta Front Panel Floor Modesty, 2-Piece [48x62]	\$1,130.00	\$1,130.00
6	2	DLSB	DELTA Long Structural Support Bracket for Laminate Surfaces, Set of 2	\$251.00	\$502.00
7	2	DSID.4877FA-K-OAK	Delta Side Panel for Facing Stations, 2-Piece [48x77]	\$1,330.00	\$2,660.00
8	2	DSSB	DELTA Short Side Support Bracket for Laminate Surfaces, Set of 4	\$171.00	\$342.00
9	2	ELMBF	EDGE Laminate Mobile Box File	\$907.00	\$1,814.00
10	2	GB2460	24"x60" Surface [1" Thick, Includes 2 Pre-Installed Grommets] - FAST	\$450.00	\$900.00
11	3	PG9	Plastic Gasket for BSB9	\$1.00	\$3.00
12	2	PROBC	BOOST Pro In-Line Power Block Connector	\$46.00	\$92.00
13	2	PRODB	BOOST Pro Double Power Block	\$249.00	\$498.00
14	1	PROIF72	BOOST Pro 72" In-feed	\$384.00	\$384.00
15	1	PROJ24	BOOST Pro 24" Jumper	\$191.00	\$191.00
16	1	PROR1	BOOST Pro Duplex Receptacle Circuit 3	\$52.00	\$52.00
17	1	PROR2	BOOST Pro Duplex Receptacle, Controlled, Circuit 4	\$52.00	\$52.00
18	2	PROR3	BOOST Pro Duplex Receptacle Circuit 1	\$52.00	\$104.00
19	2	PROR4	BOOST Pro Duplex Receptacle Circuit 2	\$52.00	\$104.00
20	2	PROSB	BOOST Pro Single Power Block	\$172.00	\$344.00
21	4	TBRC1830	30" Tackboard with Rounded Corners, Velcro for Mounting	\$172.00	\$688.00
22	2	TBRC1859	59" Tackboard with Rounded Corners, Velcro for Mounting	\$205.00	\$410.00
				Total Clear Design	\$12,790.00

DFH2460-F4

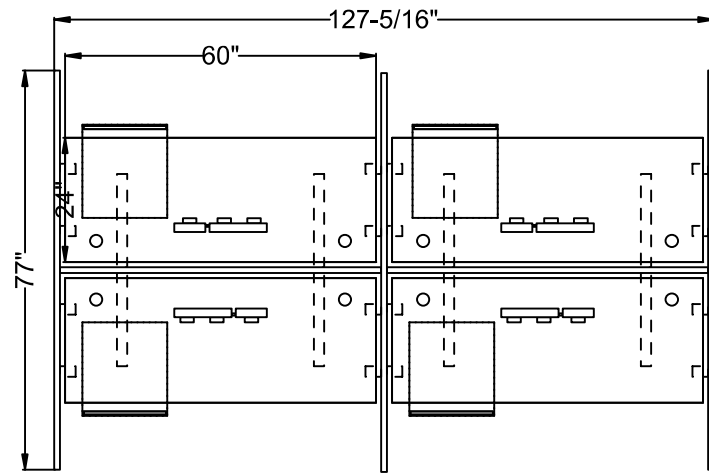

#	Quantity	Part Number	Description	List	Ext. List
Clear Design					
1	2	B12GS59	59" Dry Erase Frosted Glass Divider [13" High]	\$626.00	\$1,252.00
2	3	B12GS74	74" Dry Erase Frosted Glass Divider [13" High]	\$748.00	\$2,244.00
3	4	BWM36	Benching Wire Manager, 36" Wide	\$125.00	\$500.00
4	4	DFHPM	Delta Fixed Height Power Mounting Bracket	\$74.00	\$296.00
5	2	DFRO.4862-K-OAK	Delta Front Panel Floor Modesty, 2-Piece [48x62]	\$1,130.00	\$2,260.00
6	4	DLSB	DELTA Long Structural Support Bracket for Laminate Surfaces, Set of 2	\$251.00	\$1,004.00
7	3	DSID.4877FA-K-OAK	Delta Side Panel for Facing Stations, 2-Piece [48x77]	\$1,330.00	\$3,990.00
8	4	DSSB	DELTA Short Side Support Bracket for Laminate Surfaces, Set of 4	\$171.00	\$684.00
9	4	ELMBF	EDGE Laminate Mobile Box File	\$907.00	\$3,628.00
10	4	GB2460	24"x60" Surface [1" Thick, Includes 2 Pre-Installed Grommets] - FAST	\$450.00	\$1,800.00
11	5	PG9	Plastic Gasket for BSB9	\$1.00	\$5.00
12	4	PROBC	BOOST Pro In-Line Power Block Connector	\$46.00	\$184.00
13	4	PRODB	BOOST Pro Double Power Block	\$249.00	\$996.00
14	1	PROIF72	BOOST Pro 72" In-feed	\$384.00	\$384.00
15	1	PROJ24	BOOST Pro 24" Jumper	\$191.00	\$191.00
16	2	PROJ49	BOOST Pro 49" Jumper	\$277.00	\$554.00
17	2	PROR1	BOOST Pro Duplex Receptacle, Controlled, Circuit 4	\$52.00	\$104.00
18	2	PROR2	BOOST Pro Duplex Receptacle Circuit 3	\$52.00	\$104.00
19	4	PROR3	BOOST Pro Duplex Receptacle, Controlled, Circuit 4	\$52.00	\$208.00
20	4	PROR4	BOOST Pro Duplex Receptacle Circuit 1	\$52.00	\$208.00
21	4	PROSB	BOOST Pro Single Power Block	\$172.00	\$688.00
22	8	TBRC1830	30" Tackboard with Rounded Corners, Velcro for Mounting	\$172.00	\$1,376.00
23	4	TBRC1859	59" Tackboard with Rounded Corners, Velcro for Mounting	\$205.00	\$820.00
				Total Clear Design	\$23,480.00

DFH2472-F2

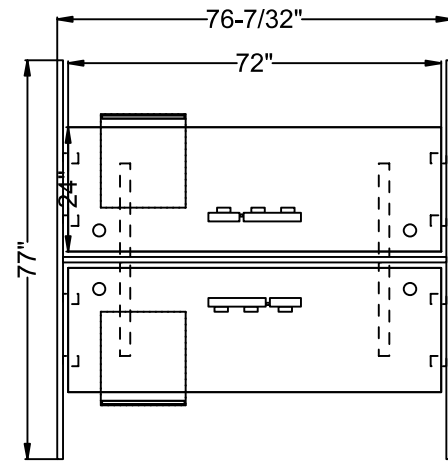

#	Quantity	Part Number	Description	List	Ext. List
Clear Design					
1	1	B12GS70	71" Dry-Erase Frosted Glass Divider [13" High]	\$748.00	\$748.00
2	2	B12GS74	74" Dry Erase Frosted Glass Divider [13" High]	\$748.00	\$1,496.00
3	2	BWM36	Benching Wire Manager, 36" Wide	\$125.00	\$250.00
4	2	DFHPM	Delta Fixed Height Power Mounting Bracket	\$74.00	\$148.00
5	1	DFRO.4874-K-OAK	Delta Front Panel Floor Modesty, 2-Piece [48x74]	\$1,254.00	\$1,254.00
6	2	DLSB	DELTA Long Structural Support Bracket for Laminate Surfaces, Set of 2	\$251.00	\$502.00
7	2	DSID.4877FA-K-OAK	Delta Side Panel for Facing Stations, 2-Piece [48x77]	\$1,330.00	\$2,660.00
8	2	DSSB	DELTA Short Side Support Bracket for Laminate Surfaces, Set of 4	\$171.00	\$342.00
9	2	ELMBF	EDGE Laminate Mobile Box File	\$907.00	\$1,814.00
10	2	GB2472	24"x72" Surface [1" Thick, Includes 2 Pre-Installed Grommets] - FAST	\$532.00	\$1,064.00
11	3	PG9	Plastic Gasket for BSB9	\$1.00	\$3.00
12	2	PROBC	BOOST Pro In-Line Power Block Connector	\$46.00	\$92.00
13	2	PRODB	BOOST Pro Double Power Block	\$249.00	\$498.00
14	1	PROIF72	BOOST Pro 72" In-feed	\$384.00	\$384.00
15	1	PROJ24	BOOST Pro 24" Jumper	\$191.00	\$191.00
16	1	PROR1	BOOST Pro Duplex Receptacle, Controlled, Circuit 4	\$52.00	\$52.00
17	2	PROR2	BOOST Pro Duplex Receptacle Circuit 1	\$52.00	\$104.00
18	2	PROR3	BOOST Pro Duplex Receptacle Circuit 2	\$52.00	\$104.00
19	1	PROR4	BOOST Pro Duplex Receptacle Circuit 3	\$52.00	\$52.00
20	2	PROSB	BOOST Pro Single Power Block	\$172.00	\$344.00
21	4	TBRC1830	30" Tackboard with Rounded Corners, Velcro for Mounting	\$172.00	\$688.00
22	2	TBRC1871	71" Tackboard with Rounded Corners, Velcro for Mounting	\$248.00	\$496.00
				Total Clear Design	\$13,286.00

DFH2472-F4

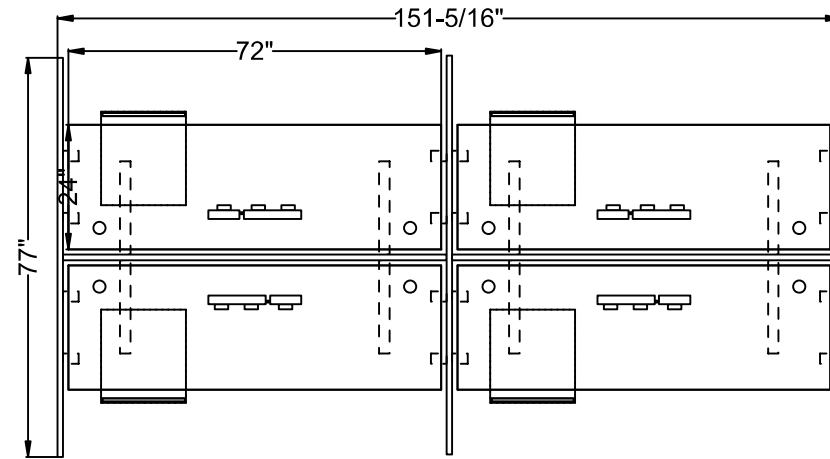

#	Quantity	Part Number	Description	List	Ext. List
Clear Design					
1	2	B12GS70	71" Dry-Erase Frosted Glass Divider [13" High]	\$748.00	\$1,496.00
2	3	B12GS74	74" Dry Erase Frosted Glass Divider [13" High]	\$748.00	\$2,244.00
3	4	BWM36	Benching Wire Manager, 36" Wide	\$125.00	\$500.00
4	4	DFHPM	Delta Fixed Height Power Mounting Bracket	\$74.00	\$296.00
5	2	DFRO.4874-K-OAK	Delta Front Panel Floor Modesty, 2-Piece [48x74]	\$1,254.00	\$2,508.00
6	4	DLSB	DELTA Long Structural Support Bracket for Laminate Surfaces, Set of 2	\$251.00	\$1,004.00
7	3	DSID.4877FA-K-OAK	Delta Side Panel for Facing Stations, 2-Piece [48x77]	\$1,330.00	\$3,990.00
8	4	DSSB	DELTA Short Side Support Bracket for Laminate Surfaces, Set of 4	\$171.00	\$684.00
9	4	ELMBF	EDGE Laminate Mobile Box File	\$907.00	\$3,628.00
10	4	GB2472	24"x72" Surface [1" Thick, Includes 2 Pre-Installed Grommets] - FAST	\$532.00	\$2,128.00
11	5	PG9	Plastic Gasket for BSB9	\$1.00	\$5.00
12	4	PROBC	BOOST Pro In-Line Power Block Connector	\$46.00	\$184.00
13	4	PRODB	BOOST Pro Double Power Block	\$249.00	\$996.00
14	1	PROIF72	BOOST Pro 72" In-feed	\$384.00	\$384.00
15	1	PROJ24	BOOST Pro 24" Jumper	\$191.00	\$191.00
16	2	PROJ61	BOOST Pro 61" Jumper	\$326.00	\$652.00
17	4	PROR1	BOOST Pro Duplex Receptacle, Controlled, Circuit 4	\$52.00	\$208.00
18	2	PROR2	BOOST Pro Duplex Receptacle Circuit 2	\$52.00	\$104.00
19	2	PROR3	BOOST Pro Duplex Receptacle Circuit 2	\$52.00	\$104.00
20	4	PROR4	BOOST Pro Duplex Receptacle Circuit 3	\$52.00	\$208.00
21	4	PROSB	BOOST Pro Single Power Block	\$172.00	\$688.00
22	8	TBRC1830	30" Tackboard with Rounded Corners, Velcro for Mounting	\$172.00	\$1,376.00
23	4	TBRC1871	71" Tackboard with Rounded Corners, Velcro for Mounting	\$248.00	\$992.00
				Total Clear Design	\$24,570.00

DFH3060-F2

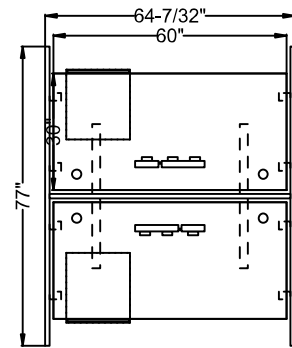

#	Quantity	Part Number	Description	List	Ext. List
Clear Design					
1	1	B12GS59	59" Dry Erase Frosted Glass Divider [13" High]	\$626.00	\$626.00
2	2	B12GS74	74" Dry Erase Frosted Glass Divider [13" High]	\$748.00	\$1,496.00
3	2	BWM36	Benching Wire Manager, 36" Wide	\$125.00	\$250.00
4	2	DFHPM	Delta Fixed Height Power Mounting Bracket	\$74.00	\$148.00
5	1	DFRO.4862-K-OAK	Delta Front Panel Floor Modesty, 2-Piece [48x62]	\$1,130.00	\$1,130.00
6	2	DLSB	DELTA Long Structural Support Bracket for Laminate Surfaces, Set of 2	\$251.00	\$502.00
7	2	DSID.4877FA-K-OAK	Delta Side Panel for Facing Stations, 2-Piece [48x77]	\$1,330.00	\$2,660.00
8	2	DSSB	DELTA Short Side Support Bracket for Laminate Surfaces, Set of 4	\$171.00	\$342.00
9	2	ELMBF	EDGE Laminate Mobile Box File	\$907.00	\$1,814.00
10	2	GB3060	30"x60" Surface [1" Thick, Includes 2 Pre-Installed Grommets] - FAST	\$575.00	\$1,150.00
11	3	PG9	Plastic Gasket for BSB9	\$1.00	\$3.00
12	2	PROBC	BOOST Pro In-Line Power Block Connector	\$46.00	\$92.00
13	2	PRODB	BOOST Pro Double Power Block	\$249.00	\$498.00
14	1	PROIF72	BOOST Pro 72" In-feed	\$384.00	\$384.00
15	1	PROJ24	BOOST Pro 24" Jumper	\$191.00	\$191.00
16	1	PROR1	BOOST Pro Duplex Receptacle Circuit 1	\$52.00	\$52.00
17	2	PROR2	BOOST Pro Duplex Receptacle Circuit 1	\$52.00	\$104.00
18	1	PROR3	BOOST Pro Duplex Receptacle Circuit 2	\$52.00	\$52.00
19	2	PROR4	BOOST Pro Duplex Receptacle Circuit 3	\$52.00	\$104.00
20	2	PROSB	BOOST Pro Single Power Block	\$172.00	\$344.00
21	4	TBRC1830	30" Tackboard with Rounded Corners, Velcro for Mounting	\$172.00	\$688.00
22	2	TBRC1859	59" Tackboard with Rounded Corners, Velcro for Mounting	\$205.00	\$410.00
				Total Clear Design	\$13,040.00

DFH3060-F4

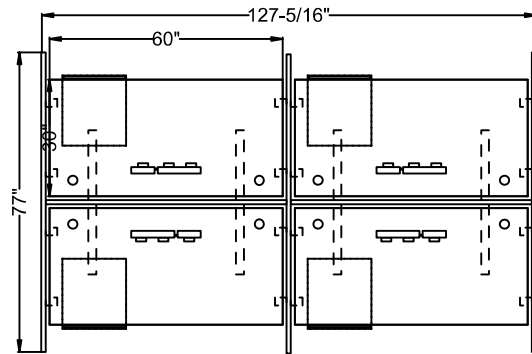

#	Quantity	Part Number	Description	List	Ext. List
Clear Design					
1	2	B12GS59	59" Dry Erase Frosted Glass Divider [13" High]	\$626.00	\$1,252.00
2	3	B12GS74	74" Dry Erase Frosted Glass Divider [13" High]	\$748.00	\$2,244.00
3	4	BWM36	Benching Wire Manager, 36" Wide	\$125.00	\$500.00
4	4	DFHPM	Delta Fixed Height Power Mounting Bracket	\$74.00	\$296.00
5	2	DFRO.4862-K-OAK	Delta Front Panel Floor Modesty, 2-Piece [48x62]	\$1,130.00	\$2,260.00
6	4	DLSB	DELTA Long Structural Support Bracket for Laminate Surfaces, Set of 2	\$251.00	\$1,004.00
7	3	DSID.4877FA-K-OAK	Delta Side Panel for Facing Stations, 2-Piece [48x77]	\$1,330.00	\$3,990.00
8	4	DSSB	DELTA Short Side Support Bracket for Laminate Surfaces, Set of 4	\$171.00	\$684.00
9	4	ELMBF	EDGE Laminate Mobile Box File	\$907.00	\$3,628.00
10	4	GB3060	30"x60" Surface [1" Thick, Includes 2 Pre-Installed Grommets] - FAST	\$575.00	\$2,300.00
11	5	PG9	Plastic Gasket for BSB9	\$1.00	\$5.00
12	4	PROBC	BOOST Pro In-Line Power Block Connector	\$46.00	\$184.00
13	4	PRODB	BOOST Pro Double Power Block	\$249.00	\$996.00
14	1	PROIF72	BOOST Pro 72" In-feed	\$384.00	\$384.00
15	1	PROJ24	BOOST Pro 24" Jumper	\$191.00	\$191.00
16	2	PROJ49	BOOST Pro 49" Jumper	\$277.00	\$554.00
17	3	PROR1	BOOST Pro Duplex Receptacle, Controlled, Circuit 4	\$52.00	\$156.00
18	3	PROR2	BOOST Pro Duplex Receptacle Circuit 1	\$52.00	\$156.00
19	2	PROR3	BOOST Pro Duplex Receptacle Circuit 2	\$52.00	\$104.00
20	4	PROR4	BOOST Pro Duplex Receptacle Circuit 3	\$52.00	\$208.00
21	4	PROSB	BOOST Pro Single Power Block	\$172.00	\$688.00
22	8	TBRC1830	30" Tackboard with Rounded Corners, Velcro for Mounting	\$172.00	\$1,376.00
23	4	TBRC1859	59" Tackboard with Rounded Corners, Velcro for Mounting	\$205.00	\$820.00
				Total Clear Design	\$23,980.00

DFH3072-F2

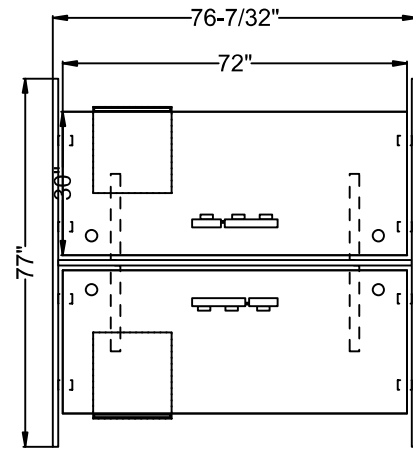

#	Quantity	Part Number	Description	List	Ext. List
Clear Design					
1	1	B12GS70	71" Dry-Erase Frosted Glass Divider [13" High]	\$748.00	\$748.00
2	2	B12GS74	74" Dry Erase Frosted Glass Divider [13" High]	\$748.00	\$1,496.00
3	2	BWM36	Benching Wire Manager, 36" Wide	\$125.00	\$250.00
4	2	DFHPM	Delta Fixed Height Power Mounting Bracket	\$74.00	\$148.00
5	1	DFRO.4874-K-OAK	Delta Front Panel Floor Modesty, 2-Piece [48x74]	\$1,254.00	\$1,254.00
6	2	DLSB	DELTA Long Structural Support Bracket for Laminate Surfaces, Set of 2	\$251.00	\$502.00
7	2	DSID.4877FA-K-OAK	Delta Side Panel for Facing Stations, 2-Piece [48x77]	\$1,330.00	\$2,660.00
8	2	DSSB	DELTA Short Side Support Bracket for Laminate Surfaces, Set of 4	\$171.00	\$342.00
9	2	ELMBF	EDGE Laminate Mobile Box File	\$907.00	\$1,814.00
10	2	GB3072	30"x72" Surface [1" Thick, Includes 2 Pre-Installed Grommets] - FAST	\$660.00	\$1,320.00
11	3	PG9	Plastic Gasket for BSB9	\$1.00	\$3.00
12	2	PROBC	BOOST Pro In-Line Power Block Connector	\$46.00	\$92.00
13	2	PRODB	BOOST Pro Double Power Block	\$249.00	\$498.00
14	1	PROIF72	BOOST Pro 72" In-feed	\$384.00	\$384.00
15	1	PROJ24	BOOST Pro 24" Jumper	\$191.00	\$191.00
16	1	PROR1	BOOST Pro Duplex Receptacle, Controlled, Circuit 4	\$52.00	\$52.00
17	2	PROR2	BOOST Pro Duplex Receptacle Circuit 1	\$52.00	\$104.00
18	2	PROR3	BOOST Pro Duplex Receptacle Circuit 2	\$52.00	\$104.00
19	1	PROR4	BOOST Pro Duplex Receptacle Circuit 3	\$52.00	\$52.00
20	2	PROSB	BOOST Pro Single Power Block	\$172.00	\$344.00
21	4	TBRC1830	30" Tackboard with Rounded Corners, Velcro for Mounting	\$172.00	\$688.00
22	2	TBRC1871	71" Tackboard with Rounded Corners, Velcro for Mounting	\$248.00	\$496.00
				Total Clear Design	\$13,542.00

DFH3072-F4

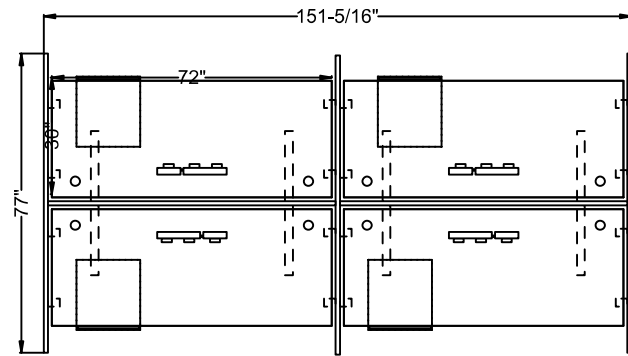

#	Quantity	Part Number	Description	List	Ext. List
Clear Design					
1	2	B12GS70	71" Dry-Erase Frosted Glass Divider [13" High]	\$748.00	\$1,496.00
2	3	B12GS74	74" Dry Erase Frosted Glass Divider [13" High]	\$748.00	\$2,244.00
3	4	BWM36	Benching Wire Manager, 36" Wide	\$125.00	\$500.00
4	4	DFHPM	Delta Fixed Height Power Mounting Bracket	\$74.00	\$296.00
5	2	DFRO.4874-K-OAK	Delta Front Panel Floor Modesty, 2-Piece [48x74]	\$1,254.00	\$2,508.00
6	4	DLSB	DELTA Long Structural Support Bracket for Laminate Surfaces, Set of 2	\$251.00	\$1,004.00
7	3	DSID.4877FA-K-OAK	Delta Side Panel for Facing Stations, 2-Piece [48x77]	\$1,330.00	\$3,990.00
8	4	DSSB	DELTA Short Side Support Bracket for Laminate Surfaces, Set of 4	\$171.00	\$684.00
9	4	ELMBF	EDGE Laminate Mobile Box File	\$907.00	\$3,628.00
10	4	GB3072	30"x72" Surface [1" Thick, Includes 2 Pre-Installed Grommets] - FAST	\$660.00	\$2,640.00
11	5	PG9	Plastic Gasket for BSB9	\$1.00	\$5.00
12	4	PROBC	BOOST Pro In-Line Power Block Connector	\$46.00	\$184.00
13	4	PRODB	BOOST Pro Double Power Block	\$249.00	\$996.00
14	1	PROIF72	BOOST Pro 72" In-feed	\$384.00	\$384.00
15	1	PROJ24	BOOST Pro 24" Jumper	\$191.00	\$191.00
16	2	PROJ61	BOOST Pro 61" Jumper	\$326.00	\$652.00
17	3	PROR1	BOOST Pro Duplex Receptacle Circuit 3	\$52.00	\$156.00
18	3	PROR2	BOOST Pro Duplex Receptacle, Controlled, Circuit 4	\$52.00	\$156.00
19	4	PROR3	BOOST Pro Duplex Receptacle Circuit 1	\$52.00	\$208.00
20	2	PROR4	BOOST Pro Duplex Receptacle Circuit 1	\$52.00	\$104.00
21	4	PROSB	BOOST Pro Single Power Block	\$172.00	\$688.00
22	8	TBRC1830	30" Tackboard with Rounded Corners, Velcro for Mounting	\$172.00	\$1,376.00
23	4	TBRC1871	71" Tackboard with Rounded Corners, Velcro for Mounting	\$248.00	\$992.00
				Total Clear Design	\$25,082.00

DFHM2460R2448-F2

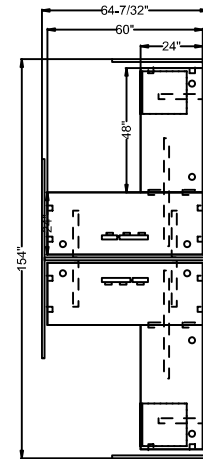

#	Quantity	Part Number	Description	List	Ext. List
Clear Design					
1	2	B12GS33	33" Dry Erase Frosted Glass Divider [13" High]	\$360.00	\$720.00
2	1	B12GS59	59" Dry Erase Frosted Glass Divider [13" High]	\$626.00	\$626.00
3	3	B12GS74	74" Dry Erase Frosted Glass Divider [13" High]	\$748.00	\$2,244.00
4	2	BASB72	42" Support Bar	\$173.00	\$346.00
5	4	BFB1	Flat Bracket	\$8.00	\$32.00
6	2	BWM36	Benching Wire Manager, 36" Wide	\$125.00	\$250.00
7	2	DEND.4836	Delta End Panel for Return Leg [48x36]	\$747.00	\$1,494.00
8	2	DFHPM	Delta Fixed Height Power Mounting Bracket	\$74.00	\$148.00
9	1	DFRO.4862-K-OAK	Delta Front Panel Floor Modesty, 2-Piece [48x62]	\$1,130.00	\$1,130.00
10	3	DLSB	DELTA Long Structural Support Bracket for Laminate Surfaces, Set of 2	\$251.00	\$753.00
11	2	DRET.4877FA-K-OAK	Delta Return Panel for Facing Stations, 2-Piece [48x77]	\$1,382.00	\$2,764.00
12	1	DSID.4877FA-K-OAK	Delta Side Panel for Facing Stations, 2-Piece [48x77]	\$1,330.00	\$1,330.00
13	3	DSSB	DELTA Short Side Support Bracket for Laminate Surfaces, Set of 4	\$171.00	\$513.00
14	2	ELMBF	EDGE Laminate Mobile Box File	\$907.00	\$1,814.00
15	2	GB2448	24"x48" Surface [1" Thick, Includes 2 Pre-Installed Grommets] - FAST	\$363.00	\$726.00
16	2	GB2460	24"x60" Surface [1" Thick, Includes 2 Pre-Installed Grommets] - FAST	\$450.00	\$900.00
17	6	PG9	Plastic Gasket for BSB9	\$1.00	\$6.00
18	2	PROBC	BOOST Pro In-Line Power Block Connector	\$46.00	\$92.00
19	2	PRODB	BOOST Pro Double Power Block	\$249.00	\$498.00
20	1	PROIF72	BOOST Pro 72" In-feed	\$384.00	\$384.00
21	1	PROJ24	BOOST Pro 24" Jumper	\$191.00	\$191.00
22	2	PROR2	BOOST Pro Duplex Receptacle Circuit 1	\$52.00	\$104.00
23	2	PROR3	BOOST Pro Duplex Receptacle Circuit 2	\$52.00	\$104.00
24	2	PROR4	BOOST Pro Duplex Receptacle Circuit 3	\$52.00	\$104.00
25	2	PROSB	BOOST Pro Single Power Block	\$172.00	\$344.00
26	2	TBRC1830	30" Tackboard with Rounded Corners, Velcro for Mounting	\$172.00	\$344.00
27	2	TBRC1859	59" Tackboard with Rounded Corners, Velcro for Mounting	\$205.00	\$410.00
28	2	TBRC1871	71" Tackboard with Rounded Corners, Velcro for Mounting	\$248.00	\$496.00

Total Clear Design \$18,867.00

DFHM2460R2448-F4

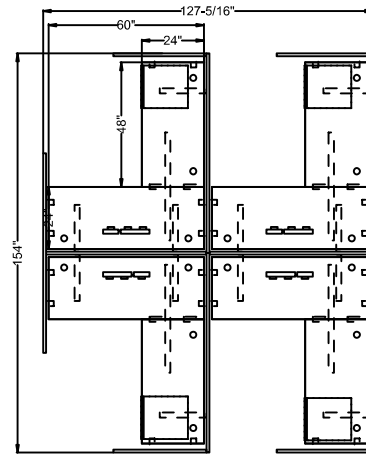

#	Quantity	Part Number	Description	List	Ext. List
Clear Design					
1	4	B12GS33	33" Dry Erase Frosted Glass Divider [13" High]	\$360.00	\$1,440.00
2	2	B12GS59	59" Dry Erase Frosted Glass Divider [13" High]	\$626.00	\$1,252.00
3	5	B12GS74	74" Dry Erase Frosted Glass Divider [13" High]	\$748.00	\$3,740.00
4	4	BASB72	42" Support Bar	\$173.00	\$692.00
5	8	BFB1	Flat Bracket	\$8.00	\$64.00
6	4	BWM36	Benching Wire Manager, 36" Wide	\$125.00	\$500.00
7	4	DEND.4836	Delta End Panel for Return Leg [48x36]	\$747.00	\$2,988.00
8	4	DFHPM	Delta Fixed Height Power Mounting Bracket	\$74.00	\$296.00
9	2	DFRO.4862-K-OAK	Delta Front Panel Floor Modesty, 2-Piece [48x62]	\$1,130.00	\$2,260.00
10	6	DLSB	DELTA Long Structural Support Bracket for Laminate Surfaces, Set of 2	\$251.00	\$1,506.00
11	4	DRET.4877FA-K-OAK	Delta Return Panel for Facing Stations, 2-Piece [48x77]	\$1,382.00	\$5,528.00
12	1	DSID.4877FA-K-OAK	Delta Side Panel for Facing Stations, 2-Piece [48x77]	\$1,330.00	\$1,330.00
13	6	DSSB	DELTA Short Side Support Bracket for Laminate Surfaces, Set of 4	\$171.00	\$1,026.00
14	4	ELMBF	EDGE Laminate Mobile Box File	\$907.00	\$3,628.00
15	4	GB2448	24"x48" Surface [1" Thick, Includes 2 Pre-Installed Grommets] - FAST	\$363.00	\$1,452.00
16	4	GB2460	24"x60" Surface [1" Thick, Includes 2 Pre-Installed Grommets] - FAST	\$450.00	\$1,800.00
17	11	PG9	Plastic Gasket for BSB9	\$1.00	\$11.00
18	4	PROBC	BOOST Pro In-Line Power Block Connector	\$46.00	\$184.00
19	4	PRODB	BOOST Pro Double Power Block	\$249.00	\$996.00
20	1	PROIF72	BOOST Pro 72" In-feed	\$384.00	\$384.00
21	1	PROJ24	BOOST Pro 24" Jumper	\$191.00	\$191.00
22	2	PROJ49	BOOST Pro 49" Jumper	\$277.00	\$554.00
23	2	PROR1	BOOST Pro Duplex Receptacle Circuit 3	\$52.00	\$104.00
24	3	PROR2	BOOST Pro Duplex Receptacle Circuit 2	\$52.00	\$156.00
25	3	PROR3	BOOST Pro Duplex Receptacle Circuit 3	\$52.00	\$156.00
26	4	PROR4	BOOST Pro Duplex Receptacle, Controlled, Circuit 4	\$52.00	\$208.00
27	4	PROSB	BOOST Pro Single Power Block	\$172.00	\$688.00
28	2	TBRC1830	30" Tackboard with Rounded Corners, Velcro for Mounting	\$172.00	\$344.00
29	4	TBRC1859	59" Tackboard with Rounded Corners, Velcro for Mounting	\$205.00	\$820.00
30	6	TBRC1871	71" Tackboard with Rounded Corners, Velcro for Mounting	\$248.00	\$1,488.00

Total Clear Design \$35,786.00

DFHM2472R2448-F2

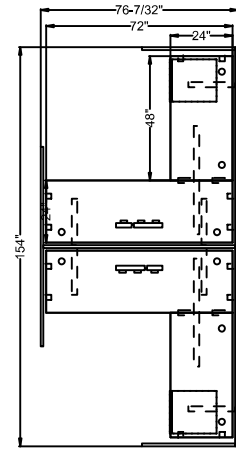

#	Quantity	Part Number	Description	List	Ext. List
Clear Design					
1	2	B12GS33	33" Dry Erase Frosted Glass Divider [13" High]	\$360.00	\$720.00
2	1	B12GS70	71" Dry-Erase Frosted Glass Divider [13" High]	\$748.00	\$748.00
3	3	B12GS74	74" Dry Erase Frosted Glass Divider [13" High]	\$748.00	\$2,244.00
4	2	BASB72	42" Support Bar	\$173.00	\$346.00
5	4	BFB1	Flat Bracket	\$8.00	\$32.00
6	2	BWM36	Benching Wire Manager, 36" Wide	\$125.00	\$250.00
7	2	DEND.4836	Delta End Panel for Return Leg [48x36]	\$747.00	\$1,494.00
8	2	DFHPM	Delta Fixed Height Power Mounting Bracket	\$74.00	\$148.00
9	1	DFRO.4874-K-OAK	Delta Front Panel Floor Modesty, 2-Piece [48x74]	\$1,254.00	\$1,254.00
10	3	DLSB	DELTA Long Structural Support Bracket for Laminate Surfaces, Set of 2	\$251.00	\$753.00
11	2	DRET.4877FA-K-OAK	Delta Return Panel for Facing Stations, 2-Piece [48x77]	\$1,382.00	\$2,764.00
12	1	DSID.4877FA-K-OAK	Delta Side Panel for Facing Stations, 2-Piece [48x77]	\$1,330.00	\$1,330.00
13	3	DSSB	DELTA Short Side Support Bracket for Laminate Surfaces, Set of 4	\$171.00	\$513.00
14	2	ELMBF	EDGE Laminate Mobile Box File	\$907.00	\$1,814.00
15	2	GB2448	24"x48" Surface [1" Thick, Includes 2 Pre-Installed Grommets] - FAST	\$363.00	\$726.00
16	2	GB2472	24"x72" Surface [1" Thick, Includes 2 Pre-Installed Grommets] - FAST	\$532.00	\$1,064.00
17	6	PG9	Plastic Gasket for BSB9	\$1.00	\$6.00
18	2	PROBC	BOOST Pro In-Line Power Block Connector	\$46.00	\$92.00
19	2	PRODB	BOOST Pro Double Power Block	\$249.00	\$498.00
20	1	PROIF72	BOOST Pro 72" In-feed	\$384.00	\$384.00
21	1	PROJ24	BOOST Pro 24" Jumper	\$191.00	\$191.00
22	1	PROR1	BOOST Pro Duplex Receptacle, Controlled, Circuit 4	\$52.00	\$52.00
23	2	PROR2	BOOST Pro Duplex Receptacle Circuit 1	\$52.00	\$104.00
24	2	PROR3	BOOST Pro Duplex Receptacle Circuit 2	\$52.00	\$104.00
25	1	PROR4	BOOST Pro Duplex Receptacle Circuit 3	\$52.00	\$52.00
26	2	PROSB	BOOST Pro Single Power Block	\$172.00	\$344.00
27	2	TBRC1830	30" Tackboard with Rounded Corners, Velcro for Mounting	\$172.00	\$344.00
28	4	TBRC1871	71" Tackboard with Rounded Corners, Velcro for Mounting	\$248.00	\$992.00

Total Clear Design \$19,363.00

DFHM2472R2448-F4

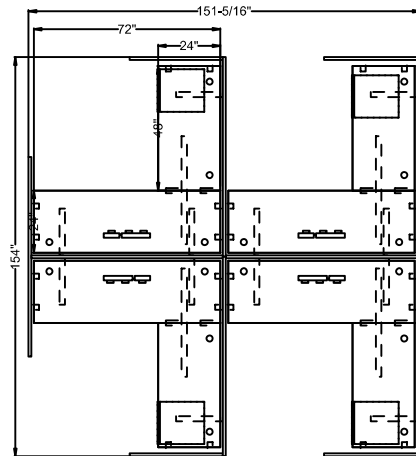

#	Quantity	Part Number	Description	List	Ext. List
Clear Design					
1	4	B12GS33	33" Dry Erase Frosted Glass Divider [13" High]	\$360.00	\$1,440.00
2	2	B12GS70	71" Dry-Erase Frosted Glass Divider [13" High]	\$748.00	\$1,496.00
3	5	B12GS74	74" Dry Erase Frosted Glass Divider [13" High]	\$748.00	\$3,740.00
4	4	BASB72	42" Support Bar	\$173.00	\$692.00
5	8	BFB1	Flat Bracket	\$8.00	\$64.00
6	4	BWM36	Benching Wire Manager, 36" Wide	\$125.00	\$500.00
7	4	DEND.4836	Delta End Panel for Return Leg [48x36]	\$747.00	\$2,988.00
8	4	DFHPM	Delta Fixed Height Power Mounting Bracket	\$74.00	\$296.00
9	2	DFRO.4874-K-OAK	Delta Front Panel Floor Modesty, 2-Piece [48x74]	\$1,254.00	\$2,508.00
10	6	DLSB	DELTA Long Structural Support Bracket for Laminate Surfaces, Set of 2	\$251.00	\$1,506.00
11	4	DRET.4877FA-K-OAK	Delta Return Panel for Facing Stations, 2-Piece [48x77]	\$1,382.00	\$5,528.00
12	1	DSID.4877FA-K-OAK	Delta Side Panel for Facing Stations, 2-Piece [48x77]	\$1,330.00	\$1,330.00
13	6	DSSB	DELTA Short Side Support Bracket for Laminate Surfaces, Set of 4	\$171.00	\$1,026.00
14	4	ELMBF	EDGE Laminate Mobile Box File	\$907.00	\$3,628.00
15	4	GB2448	24"x48" Surface [1" Thick, Includes 2 Pre-Installed Grommets] - FAST	\$363.00	\$1,452.00
16	4	GB2472	24"x72" Surface [1" Thick, Includes 2 Pre-Installed Grommets] - FAST	\$532.00	\$2,128.00
17	11	PG9	Plastic Gasket for BSB9	\$1.00	\$11.00
18	4	PROBC	BOOST Pro In-Line Power Block Connector	\$46.00	\$184.00
19	4	PRODB	BOOST Pro Double Power Block	\$249.00	\$996.00
20	1	PROIF72	BOOST Pro 72" In-feed	\$384.00	\$384.00
21	1	PROJ24	BOOST Pro 24" Jumper	\$191.00	\$191.00
22	2	PROJ61	BOOST Pro 61" Jumper	\$326.00	\$652.00
23	3	PROR1	BOOST Pro Duplex Receptacle Circuit 1	\$52.00	\$156.00
24	3	PROR2	BOOST Pro Duplex Receptacle Circuit 2	\$52.00	\$156.00
25	3	PROR3	BOOST Pro Duplex Receptacle Circuit 3	\$52.00	\$156.00
26	3	PROR4	BOOST Pro Duplex Receptacle, Controlled, Circuit 4	\$52.00	\$156.00
27	4	PROSB	BOOST Pro Single Power Block	\$172.00	\$688.00
28	2	TBRC1830	30" Tackboard with Rounded Corners, Velcro for Mounting	\$172.00	\$344.00
29	10	TBRC1871	71" Tackboard with Rounded Corners, Velcro for Mounting	\$248.00	\$2,480.00
				Total Clear Design \$36,876.00	

DFHM3060R2442-F2

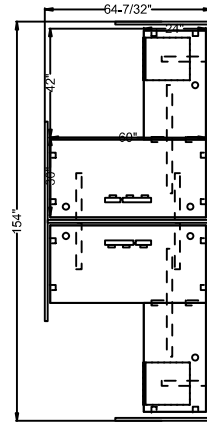

#	Quantity	Part Number	Description	List	Ext. List
Clear Design					
1	2	B12GS33	33" Dry Erase Frosted Glass Divider [13" High]	\$360.00	\$720.00
2	1	B12GS59	59" Dry Erase Frosted Glass Divider [13" High]	\$626.00	\$626.00
3	3	B12GS74	74" Dry Erase Frosted Glass Divider [13" High]	\$748.00	\$2,244.00
4	2	BASB72	42" Support Bar	\$173.00	\$346.00
5	4	BFB1	Flat Bracket	\$8.00	\$32.00
6	2	BWM36	Benching Wire Manager, 36" Wide	\$125.00	\$250.00
7	2	DEND.4836	Delta End Panel for Return Leg [48x36]	\$747.00	\$1,494.00
8	2	DFHPM	Delta Fixed Height Power Mounting Bracket	\$74.00	\$148.00
9	1	DFRO.4862-K-OAK	Delta Front Panel Floor Modesty, 2-Piece [48x62]	\$1,130.00	\$1,130.00
10	3	DLSB	DELTA Long Structural Support Bracket for Laminate Surfaces, Set of 2	\$251.00	\$753.00
11	2	DRET.4877FA-K-OAK	Delta Return Panel for Facing Stations, 2-Piece [48x77]	\$1,382.00	\$2,764.00
12	1	DSID.4877FA-K-OAK	Delta Side Panel for Facing Stations, 2-Piece [48x77]	\$1,330.00	\$1,330.00
13	3	DSSB	DELTA Short Side Support Bracket for Laminate Surfaces, Set of 4	\$171.00	\$513.00
14	2	ELMBF	EDGE Laminate Mobile Box File	\$907.00	\$1,814.00
15	2	GB2442	24"x42" Cross-Grain Surface [1" Thick, Includes 1 Pre-Installed Grommet] - FAST	\$317.00	\$634.00
16	2	GB3060	30"x60" Surface [1" Thick, Includes 2 Pre-Installed Grommets] - FAST	\$575.00	\$1,150.00
17	6	PG9	Plastic Gasket for BSB9	\$1.00	\$6.00
18	2	PROBC	BOOST Pro In-Line Power Block Connector	\$46.00	\$92.00
19	2	PRODB	BOOST Pro Double Power Block	\$249.00	\$498.00
20	1	PROIF72	BOOST Pro 72" In-feed	\$384.00	\$384.00
21	1	PROJ24	BOOST Pro 24" Jumper	\$191.00	\$191.00
22	2	PROR1	BOOST Pro Duplex Receptacle Circuit 2	\$52.00	\$104.00
23	1	PROR2	BOOST Pro Duplex Receptacle Circuit 3	\$52.00	\$52.00
24	1	PROR3	BOOST Pro Duplex Receptacle, Controlled, Circuit 4	\$52.00	\$52.00
25	2	PROR4	BOOST Pro Duplex Receptacle Circuit 1	\$52.00	\$104.00
26	2	PROSB	BOOST Pro Single Power Block	\$172.00	\$344.00
27	2	TBRC1830	30" Tackboard with Rounded Corners, Velcro for Mounting	\$172.00	\$344.00
28	2	TBRC1859	59" Tackboard with Rounded Corners, Velcro for Mounting	\$205.00	\$410.00
29	2	TBRC1871	71" Tackboard with Rounded Corners, Velcro for Mounting	\$248.00	\$496.00
				Total Clear Design	\$19,025.00

DFHM3060R2442-F4

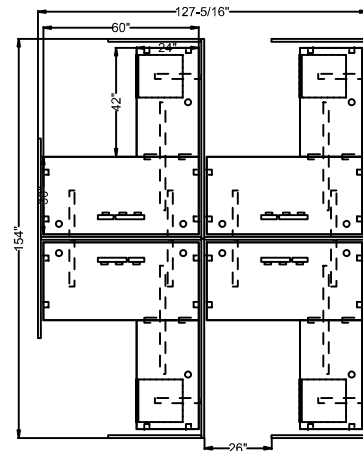

#	Quantity	Part Number	Description	List	Ext. List
Clear Design					
1	4	B12GS33	33" Dry Erase Frosted Glass Divider [13" High]	\$360.00	\$1,440.00
2	2	B12GS59	59" Dry Erase Frosted Glass Divider [13" High]	\$626.00	\$1,252.00
3	5	B12GS74	74" Dry Erase Frosted Glass Divider [13" High]	\$748.00	\$3,740.00
4	4	BASB72	42" Support Bar	\$173.00	\$692.00
5	8	BFB1	Flat Bracket	\$8.00	\$64.00
6	4	BWM36	Benching Wire Manager, 36" Wide	\$125.00	\$500.00
7	4	DEND.4836	Delta End Panel for Return Leg [48x36]	\$747.00	\$2,988.00
8	4	DFHPM	Delta Fixed Height Power Mounting Bracket	\$74.00	\$296.00
9	2	DFRO.4862-K-OAK	Delta Front Panel Floor Modesty, 2-Piece [48x62]	\$1,130.00	\$2,260.00
10	6	DLSB	DELTA Long Structural Support Bracket for Laminate Surfaces, Set of 2	\$251.00	\$1,506.00
11	4	DRET.4877FA-K-OAK	Delta Return Panel for Facing Stations, 2-Piece [48x77]	\$1,382.00	\$5,528.00
12	1	DSID.4877FA-K-OAK	Delta Side Panel for Facing Stations, 2-Piece [48x77]	\$1,330.00	\$1,330.00
13	6	DSSB	DELTA Short Side Support Bracket for Laminate Surfaces, Set of 4	\$171.00	\$1,026.00
14	4	ELMBF	EDGE Laminate Mobile Box File	\$907.00	\$3,628.00
15	4	GB2442	24"x42" Cross-Grain Surface [1" Thick, Includes 1 Pre-Installed Grommet] - FAST	\$317.00	\$1,268.00
16	4	GB3060	30"x60" Surface [1" Thick, Includes 2 Pre-Installed Grommets] - FAST	\$575.00	\$2,300.00
17	11	PG9	Plastic Gasket for BSB9	\$1.00	\$11.00
18	4	PROBC	BOOST Pro In-Line Power Block Connector	\$46.00	\$184.00
19	4	PRODB	BOOST Pro Double Power Block	\$249.00	\$996.00
20	1	PROIF72	BOOST Pro 72" In-feed	\$384.00	\$384.00
21	1	PROJ24	BOOST Pro 24" Jumper	\$191.00	\$191.00
22	2	PROJ49	BOOST Pro 49" Jumper	\$277.00	\$554.00
23	4	PROR1	BOOST Pro Duplex Receptacle, Controlled, Circuit 4	\$52.00	\$208.00
24	3	PROR2	BOOST Pro Duplex Receptacle Circuit 1	\$52.00	\$156.00
25	3	PROR3	BOOST Pro Duplex Receptacle, Controlled, Circuit 4	\$52.00	\$156.00
26	2	PROR4	BOOST Pro Duplex Receptacle Circuit 3	\$52.00	\$104.00
27	4	PROSB	BOOST Pro Single Power Block	\$172.00	\$688.00
28	2	TBRC1830	30" Tackboard with Rounded Corners, Velcro for Mounting	\$172.00	\$344.00
29	4	TBRC1859	59" Tackboard with Rounded Corners, Velcro for Mounting	\$205.00	\$820.00
30	6	TBRC1871	71" Tackboard with Rounded Corners, Velcro for Mounting	\$248.00	\$1,488.00
				Total Clear Design	\$36,102.00

DFHM3072R2442-F2

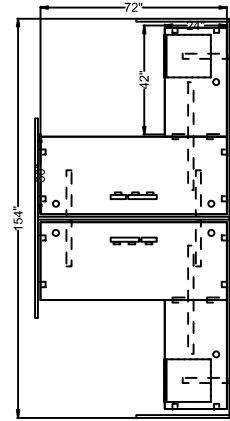

#	Quantity	Part Number	Description	List	Ext. List
Clear Design					
1	2	B12GS33	33" Dry Erase Frosted Glass Divider [13" High]	\$360.00	\$720.00
2	1	B12GS70	71" Dry-Erase Frosted Glass Divider [13" High]	\$748.00	\$748.00
3	3	B12GS74	74" Dry Erase Frosted Glass Divider [13" High]	\$748.00	\$2,244.00
4	2	BASB72	42" Support Bar	\$173.00	\$346.00
5	4	BFB1	Flat Bracket	\$8.00	\$32.00
6	2	BWM36	Benching Wire Manager, 36" Wide	\$125.00	\$250.00
7	2	DEND.4836	Delta End Panel for Return Leg [48x36]	\$747.00	\$1,494.00
8	2	DFHPM	Delta Fixed Height Power Mounting Bracket	\$74.00	\$148.00
9	1	DFRO.4874-K-OAK	Delta Front Panel Floor Modesty, 2-Piece [48x74]	\$1,254.00	\$1,254.00
10	3	DLSB	DELTA Long Structural Support Bracket for Laminate Surfaces, Set of 2	\$251.00	\$753.00
11	2	DRET.4877FA-K-OAK	Delta Return Panel for Facing Stations, 2-Piece [48x77]	\$1,382.00	\$2,764.00
12	1	DSID.4877FA-K-OAK	Delta Side Panel for Facing Stations, 2-Piece [48x77]	\$1,330.00	\$1,330.00
13	3	DSSB	DELTA Short Side Support Bracket for Laminate Surfaces, Set of 4	\$171.00	\$513.00
14	2	ELMBF	EDGE Laminate Mobile Box File	\$907.00	\$1,814.00
15	2	GB2442	24"x42" Cross-Grain Surface [1" Thick, Includes 1 Pre-Installed Grommet] - FAST	\$317.00	\$634.00
16	2	GB3072	30"x72" Surface [1" Thick, Includes 2 Pre-Installed Grommets] - FAST	\$660.00	\$1,320.00
17	6	PG9	Plastic Gasket for BSB9	\$1.00	\$6.00
18	2	PROBC	BOOST Pro In-Line Power Block Connector	\$46.00	\$92.00
19	2	PRODB	BOOST Pro Double Power Block	\$249.00	\$498.00
20	1	PROIF72	BOOST Pro 72" In-feed	\$384.00	\$384.00
21	1	PROJ24	BOOST Pro 24" Jumper	\$191.00	\$191.00
22	2	PROR1	BOOST Pro Duplex Receptacle Circuit 2	\$52.00	\$104.00
23	1	PROR2	BOOST Pro Duplex Receptacle Circuit 3	\$52.00	\$52.00
24	1	PROR3	BOOST Pro Duplex Receptacle, Controlled, Circuit 4	\$52.00	\$52.00
25	2	PROR4	BOOST Pro Duplex Receptacle Circuit 1	\$52.00	\$104.00
26	2	PROSB	BOOST Pro Single Power Block	\$172.00	\$344.00
27	2	TBRC1830	30" Tackboard with Rounded Corners, Velcro for Mounting	\$172.00	\$344.00
28	4	TBRC1871	71" Tackboard with Rounded Corners, Velcro for Mounting	\$248.00	\$992.00

Total Clear Design \$19,527.00

DFHM3072R2442-F4

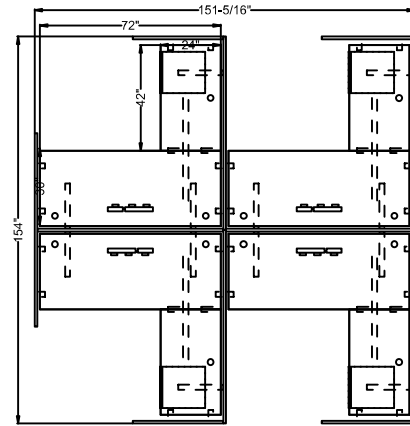

#	Quantity	Part Number	Description	List	Ext. List
Clear Design					
1	4	B12GS33	33" Dry Erase Frosted Glass Divider [13" High]	\$360.00	\$1,440.00
2	2	B12GS70	71" Dry-Erase Frosted Glass Divider [13" High]	\$748.00	\$1,496.00
3	5	B12GS74	74" Dry Erase Frosted Glass Divider [13" High]	\$748.00	\$3,740.00
4	4	BASB72	42" Support Bar	\$173.00	\$692.00
5	8	BFB1	Flat Bracket	\$8.00	\$64.00
6	4	BWM36	Benching Wire Manager, 36" Wide	\$125.00	\$500.00
7	4	DEND.4836	Delta End Panel for Return Leg [48x36]	\$747.00	\$2,988.00
8	4	DFHPM	Delta Fixed Height Power Mounting Bracket	\$74.00	\$296.00
9	2	DFRO.4874-K-OAK	Delta Front Panel Floor Modesty, 2-Piece [48x74]	\$1,254.00	\$2,508.00
10	6	DLSB	DELTA Long Structural Support Bracket for Laminate Surfaces, Set of 2	\$251.00	\$1,506.00
11	4	DRET.4877FA-K-OAK	Delta Return Panel for Facing Stations, 2-Piece [48x77]	\$1,382.00	\$5,528.00
12	1	DSID.4877FA-K-OAK	Delta Side Panel for Facing Stations, 2-Piece [48x77]	\$1,330.00	\$1,330.00
13	6	DSSB	DELTA Short Side Support Bracket for Laminate Surfaces, Set of 4	\$171.00	\$1,026.00
14	4	ELMBF	EDGE Laminate Mobile Box File	\$907.00	\$3,628.00
15	4	GB2442	24"x42" Cross-Grain Surface [1" Thick, Includes 1 Pre-Installed Grommet] - FAST	\$317.00	\$1,268.00
16	4	GB3072	30"x72" Surface [1" Thick, Includes 2 Pre-Installed Grommets] - FAST	\$660.00	\$2,640.00
17	11	PG9	Plastic Gasket for BSB9	\$1.00	\$11.00
18	4	PROBC	BOOST Pro In-Line Power Block Connector	\$46.00	\$184.00
19	4	PRODB	BOOST Pro Double Power Block	\$249.00	\$996.00
20	1	PROIF72	BOOST Pro 72" In-feed	\$384.00	\$384.00
21	1	PROJ24	BOOST Pro 24" Jumper	\$191.00	\$191.00
22	2	PROJ61	BOOST Pro 61" Jumper	\$326.00	\$652.00
23	4	PROR1	BOOST Pro Duplex Receptacle, Controlled, Circuit 4	\$52.00	\$208.00
24	3	PROR2	BOOST Pro Duplex Receptacle Circuit 1	\$52.00	\$156.00
25	2	PROR3	BOOST Pro Duplex Receptacle, Controlled, Circuit 4	\$52.00	\$104.00
26	3	PROR4	BOOST Pro Duplex Receptacle Circuit 3	\$52.00	\$156.00
27	4	PROSB	BOOST Pro Single Power Block	\$172.00	\$688.00
28	2	TBRC1830	30" Tackboard with Rounded Corners, Velcro for Mounting	\$172.00	\$344.00
29	10	TBRC1871	71" Tackboard with Rounded Corners, Velcro for Mounting	\$248.00	\$2,480.00
				Total Clear Design	\$37,204.00