



JULY 2026

**CLEAR**  
DESIGN

# Price List

# TABLE OF CONTENTS

## BLADE

Legs .....	1
Panels .....	4
Supports .....	6
Wire Management .....	7

## BOOST

Bridges .....	9
Height-Adjustable Frames .....	12
Wire Management .....	13

## BOOST PRO

Bridge-Mounted Dividers .....	15
Frame Components .....	16
Height-Adjustable .....	18
Panels .....	19
Wire Management .....	20

## HELIX

Beam-Mounted Dividers .....	21
Brackets .....	22
Frame Components .....	23
Power .....	25

## DELTA

Accessories .....	27
Fixed Height .....	28
Glass .....	29
Height-Adjustable .....	30
Wire Management .....	33

## EDGE

Desks .....	35
FAST Program .....	38
Height-Adjustable .....	39
Storage .....	40

## THREE60

Bases .....	43
Legs .....	44
Surfaces .....	45
Tables .....	47

## OPTIMA

Frames .....	49
Panels .....	50
Power .....	51

## COVE

Pods .....	53
------------	----

## KOLAB

Lounge Seating .....	55
----------------------	----

## SEATING

Accessories .....	57
Conference Chairs .....	58
Collaborative .....	59
Nesting Chairs .....	60
Nesting .....	61
Side Chairs .....	62
Stacking Chairs .....	63
Stools .....	65
Task Chairs .....	66
Task .....	68

## KIVA

Kiva .....	69
------------	----

## SURFACES

FAST Program .....	71
FX Program .....	74

## TABLES

Bases .....	97
Laptop Table .....	98
Legs .....	99
Lounge Tables .....	100

## PANELS

Brackets .....	101
End Panels .....	102
Modesty Panels .....	104

## DIVIDERS

Acrylic (Clear) .....	107
Acrylic (Frosted) .....	109
Brackets .....	111
Fabric .....	113
Glass .....	117
Height-Adjustable .....	120
PET .....	121

## TONOS

Brackets .....	123
PET Screens .....	124

## STOHR

Stohr .....	131
-------------	-----

## STORAGE

Laminate .....	133
Steel .....	137

## POWER

4-Circuit .....	139
Connector Blocks .....	142
Duplexes .....	143
Harnesses .....	144
Infeeds .....	145
Jumpers .....	146
Wire Management .....	147

## SUPPORTS

Supports .....	149
----------------	-----

## ACCESSORIES

Monitor Arm .....	151
Pillows .....	152
Power & Data Units .....	153
Storage Hook .....	155

# BLADE LEGS

IMAGE	CODE	DESCRIPTION	LIST
Components 	BLC1 BLK, SLV, WHT	BLADE Leg Connecting Bracket (V2) W 19.96" D 5.12" H 3.15"	\$98
	KIT-SHSLB BLK, SLV, WHT	BLADE Standing-Height Stability L-Bracket, Set of 4 [Includes Laminate-to-Metal Hardware] W 0.79" D 6.3" H 13.78"	\$78
Legs 	BCLEG BLK, SLV, WHT	BLADE 21.5" C-Leg [27.5" High] W 21.63" D 3.94" H 27.38"	\$278
	BL24 BLK, SLV, WHT	BLADE 24" End Leg [27.375" High] W 24" D 3.94" H 27.38"	\$278
	BL30 BLK, SLV, WHT	BLADE 30" End Leg [27.375" High] W 30" D 3.94" H 27.38"	\$291
	BL48 BLK, SLV, WHT	BLADE 48" End Leg [27.375" High] W 48" D 3.94" H 27.38"	\$416

IMAGE	CODE	DESCRIPTION	LIST
	BL48INT BLK, SLV, WHT	BLADE 48" Intermediate Leg [27.375" High, Expands to 60" Wide] W 45.51"-52.20" D 5.91" H 27.38"	\$604
	BL60 BLK, SLV, WHT	BLADE 60" End Leg [27.375" High] W 60" D 3.94" H 38.38"	\$469
	KIT-120 BLK, SLV, WHT	BLADE 120 Degree Leg [27.5" High, Includes Triangular Box] W 10.04" D 8.69" H 27.38"	\$173
Standing-Height 	BTL24 BLK, SLV, WHT	BLADE 24" Standing-Height End Leg [38.375" High] W 24" D 3.94" H 38.38"	\$358
	BTL30 BLK, SLV, WHT	BLADE 30" Standing-Height End Leg [38.375" High] W 30" D 3.94" H 38.38"	\$374
	BTL48 BLK, SLV, WHT	BLADE 48" Standing-Height End Leg [38.375" High] W 48" D 3.94" H 38.38"	\$516

# BLADE LEGS + PANELS

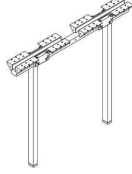
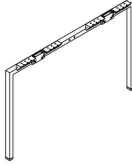
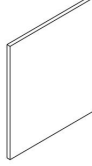
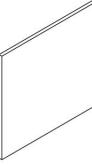
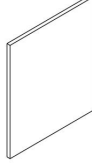

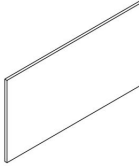
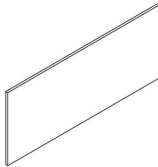
IMAGE	CODE	DESCRIPTION	LIST
	BTL48INT BLK, SLV, WHT	BLADE 48" Standing-Height Intermediate Leg [38.375" High, Expands to 60" Wide] W 45.51"-52.20" D 5.91" H 38.38"	\$732
	BTL60 BLK, SLV, WHT	BLADE 60" Standing-Height End Leg [38.375" High] W 60" D 3.94" H 38.38"	\$548

IMAGE	CODE	DESCRIPTION	LIST
FAST Laminate Inset End Panels 	GBEP20 ELM, MPL, OAK, SAH, WHT	BLADE 20" Laminate Inset End Panel [23.5" High, 0.75" Thick, For 24" Leg] - FAST W 20" D 0.75" H 23.5"	\$225
	GBEP26 ELM, MPL, OAK, SAH, WHT	BLADE 26" Laminate Inset End Panel [23.5" High, 0.75" Thick, For 30" Leg] - FAST W 26" D 0.75" H 23.5"	\$246
FX Laminate Inset End Panels 	WABEPIS.A FX	BLADE 20" Laminate Inset End Panel [23.5" High, 0.75" Thick, For 24" Leg] - FX W 20" D 0.75" H 23.5"	\$1602
	WABEPIS.B FX	BLADE 26" Laminate Inset End Panel [23.5" High, 0.75" Thick, For 30" Leg] - FX W 26" D 0.75" H 23.5"	\$1602
	WABEPIS.C FX	BLADE 45" Laminate Inset End Panel [23.5" High, 0.75" Thick, For 48" Leg] - FX W 45" D 0.75" H 23.5"	\$1602
	WABEPIS.D FX	BLADE 56.75" Laminate Inset End Panel [23.5" High, 0.75" Thick, For 60" Leg] - FX W 56.75" D 0.75" H 23.5"	\$1602

# BLADE PANELS + SUPPORTS

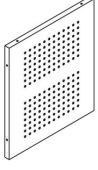
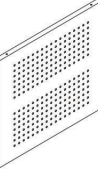
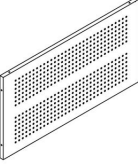
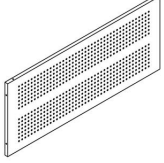
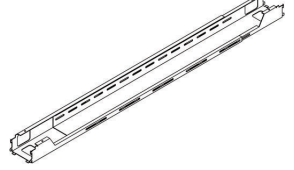
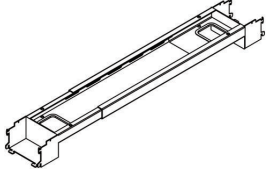
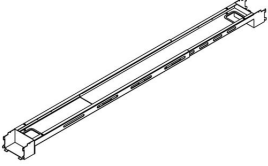
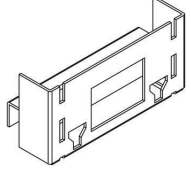
IMAGE	CODE	DESCRIPTION	LIST
Steel Inset End Panels 	BEP24 BLK, SLV, WHT	BLADE 20" Steel Inset End Panel [For 24" Leg] W 20" D 1" H 23.5"	\$238
	BEP30 BLK, SLV, WHT	BLADE 26" Steel Inset End Panel [For 30" Leg] W 26" D 1" H 23.5"	\$262
	BEP48 BLK, SLV, WHT	BLADE 45" Steel Inset End Panel [For 48" Leg] W 45" D 1" H 23.5"	\$273
	BEP60 BLK, SLV, WHT	BLADE 56.75" Steel Inset End Panel [For 60" Leg] W 56.75" D 1" H 23.5"	\$330

IMAGE	CODE	DESCRIPTION	LIST
Beams 	BB3 BLK, SLV, WHT	BLADE Extra Long Beam W 53.5"-87.88" D 4.65" H 2.76"	\$290
	BLPB1 BLK, SLV, WHT	BLADE Short Low Profile Beam W 24.45"-41.14" D 4.65" H 2.76"	\$132
	BLPB2 BLK, SLV, WHT	BLADE Long Low Profile Beam W 40"-69.74" D 4.65" H 2.76"	\$193
Components 	BBC1 SLV	BLADE Beam-to-Beam Connecting Bracket [For L-Shape Workstation] W 5.51" D 1.85" H 2.64"	\$31

# BLADE WIRE MANAGEMENT

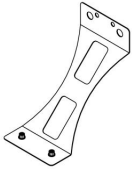
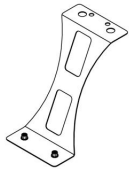
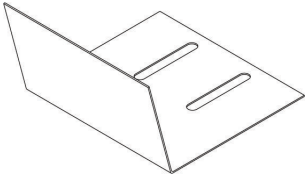
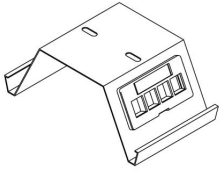
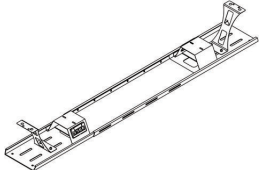
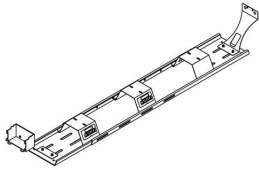
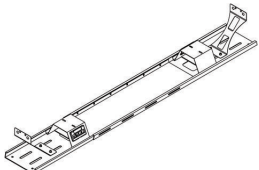
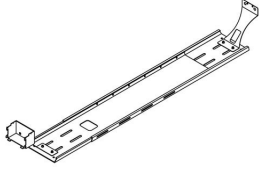
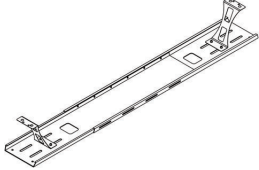
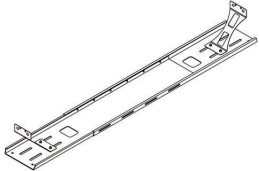
IMAGE	CODE	DESCRIPTION	LIST
Cable Tray Components 	BCTLM BLK, SLV, WHT	BLADE Leg-Mount Cable Tray Hangers, Set of 2 W 3.88" D 6.96" H 2.76"	\$44
	BCTSM BLK, SLV, WHT	BLADE Surface-Mount Cable Tray Hangers, Set of 2 W 3.88" D 5.82" H 6.25"	\$44
	BNTEC BLK, SLV, WHT	BLADE Narrow Cable Tray End Cap W 6.5" D 7" H 3.88"	\$77
	KIT-BNCT-RK BLK, SLV	BLADE Narrow Cable Tray Riser [Includes 1 Data Faceplate] W 4.17" D 6.96" H 2.76"	\$26
Cable Trays 	KIT-CTXN BLK, SLV, WHT	BLADE Narrow Surface-Mount Cable Tray [Includes Risers & Faceplates] W 41.57"-79.51" D 7.38" H 6.38"	\$306
	KIT-CTXN120 BLK, SLV, WHT	BLADE Narrow 120 Degree Leg-Mount Cable Tray [Includes Risers & Faceplates] W 58.04"-70.04" D 9.81" H 7.88"	\$359

IMAGE	CODE	DESCRIPTION	LIST
	KIT-CTXNL BLK, SLV, WHT	BLADE Narrow Leg-Mount Cable Tray [Includes Risers & Faceplates] W 43.64"-80.3" D 7.38" H 6.38"	\$306
Cable Trays - No Data 	KIT-CTXN120ND BLK, SLV, WHT	BLADE Narrow 120 Degree Leg-Mount Cable Tray W 58.04"-70.04" D 9.81" H 7.88"	\$281
	KIT-CTXNLND BLK, SLV, WHT	BLADE Narrow Leg-Mount Cable Tray W 43.64"-80.3" D 7.38" H 6.38"	\$254
	KIT-CTXNND BLK, SLV, WHT	BLADE Narrow Surface-Mount Cable Tray W 41.57"-79.51" D 7.38" H 6.38"	\$254

# BOOST BRIDGES

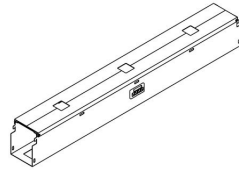
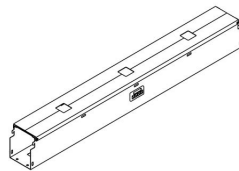
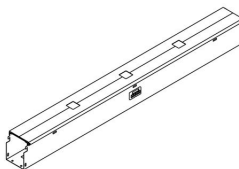
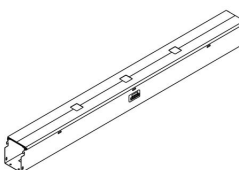
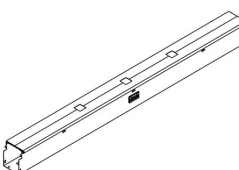
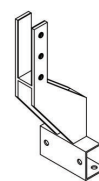
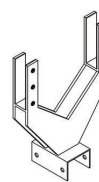
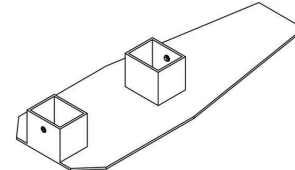
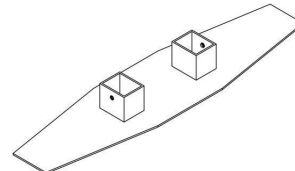
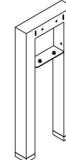
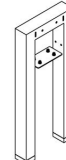
IMAGE	CODE	DESCRIPTION	LIST
Beams 	KIT-BBB120V2 BLK, SLV, WHT	BOOST 46.5" Bridge Beam (V2) [Includes Faceplates, For 120 Degree Workstation] W 48.46" D 5" H 6.28"	\$307
	KIT-BBB48V2 BLK, SLV, WHT	BOOST 49" Bridge Beam (V2) [Includes Faceplates, For 48" Workstation] W 50.93" D 5" H 6.28"	\$322
	KIT-BBB60V2 BLK, SLV, WHT	BOOST 61" Bridge Beam (V2) [Includes Faceplates, For 60" Workstation] W 62.93" D 5" H 6.28"	\$394
	KIT-BBB66V2 BLK, SLV, WHT	BOOST 67" Bridge Beam (V2) [Includes Faceplates, For 66" Workstation] W 68.93" D 5" H 6.28"	\$431
	KIT-BBB72V2 BLK, SLV, WHT	BOOST 73" Bridge Beam (V2) [Includes Faceplates, For 72" Workstation] W 75" D 5" H 6.28"	\$471
Divider Supports 	BBEPBV2 BLK, SLV, WHT	BOOST Bridge End Leg Divider Bracket (V2) W 4.37" D 3.43" H 10.51"	\$78

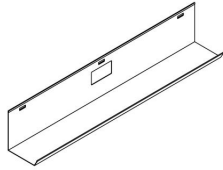
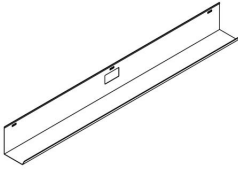
IMAGE	CODE	DESCRIPTION	LIST
	BBIPBV2 BLK, SLV, WHT	BOOST Bridge Intermediate Leg Divider Bracket (V2) W 7.87" D 3.43" H 10.51"	\$117
	BBLABV2 BLK, SLV, WHT	BOOST Bridge Asymmetric Leg Base (V2) W 16.3" D 6" H 2"	\$125
	BBLBV2 BLK, SLV, WHT	BOOST Bridge Leg Base (V2) W 24" D 6" H 2"	\$125
Legs	BBENDV2 BLK, SLV, WHT	BOOST Bridge End Leg (V2) W 8.31" D 2.15" H 19.92"	\$201
	BBINTV2 BLK, SLV, WHT	BOOST Bridge Intermediate Leg (V2) W 8.31" D 2.32" H 19.92"	\$198
	KIT-120DB BLK, SLV, WHT	BOOST Bridge 120 Degree Leg [Includes Bridge 120 Degree Leg Divider Bracket] W 11.82" D 10.94" H 29"	\$436

**BOOST** BRIDGES + HEIGHT-ADJUSTABLE FRAMES

IMAGE	CODE	DESCRIPTION	LIST
	KIT-BB120L BLK, SLV, WHT	BOOST Bridge 120 Degree Leg [Includes Triangular Box] W 10.24" D 8.86" H 19.92"	\$325

IMAGE	CODE	DESCRIPTION	LIST
Electrical	BHAGSAEXT BLK	BOOST Frame Extension Cord [55" Cord, For All GSA Frames] W 55"	\$74

# BOOST WIRE MANAGEMENT

IMAGE	CODE	DESCRIPTION	LIST
Bridge-Mounted Cable Trays 	<b>BBCT30</b> <b>BLK, SLV, WHT</b>	BOOST 30" Bridge Cable Tray [For 48" & 120 Degree Workstations] <b>W 30" D 4.84" H 5.47"</b>	\$128
	<b>BBCT50</b> <b>BLK, SLV, WHT</b>	BOOST 50" Bridge Cable Tray [For 60"-72" Workstations] <b>W 50" D 4.84" H 5.47"</b>	\$192

# BOOST PRO BRIDGE-MOUNTED DIVIDERS + FRAME COMPONENTS

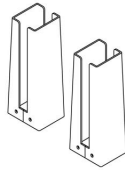
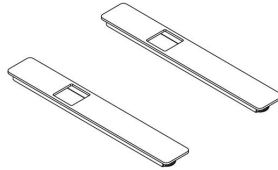
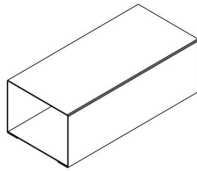
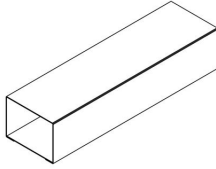
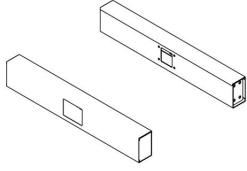
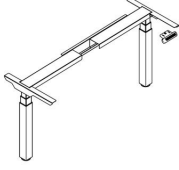
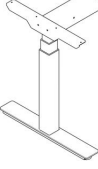
IMAGE	CODE	DESCRIPTION	LIST
 Divider Supports	BPROBRK BLK, SLV, WHT	BOOST Pro Beam-Mounted Divider Clippers, Set of 2 W 3" D 3.63" H 9.44"	\$161
 Rubber Shim [For Boost Pro Divider Clipper]	BPROMBRG BLK	Rubber Shim [For Boost Pro Divider Clipper] W 0.5" D 2" H 8.25"	\$23

IMAGE	CODE	DESCRIPTION	LIST
 Frame Components	BPRO24F BLK, SLV, WHT	BOOST Pro 24" C-Leg Feet, Set of 2 [For Single-Sided Workstations] W 3.54" D 23.62" H 1.5"	\$195
	BPROBRG1V2 BLK, SLV, WHT	BOOST Pro 7.5" Power Beam Connector (V2) [For 48"-66" Workstations] W 7.5" D 3.5" H 2.6"	\$35
	BPROBRG2V2 BLK, SLV, WHT	BOOST Pro 12.25" Power Beam Connector (V2) [For 72" Workstations] W 12.25" D 3.5" H 2.6"	\$42
	BPROCB BLK, SLV, WHT	BOOST Pro Cross Beam, Set of 2 [Includes Side Covers, For Facing Workstations] W 25.13" D 2.44" H 4"	\$293
	BPROF BLK, SLV, WHT	BOOST Pro Height-Adjustable Frame [For 48"-72" Workstations] W 46.75"-66" D 19.68" H 25.4"-51"	\$1642
	BPROLF BLK, SLV, WHT	BOOST Pro Height-Adjustable L-Shape Frame Adapter Kit W 13.86" D 19.68" H 25.4"-51"	\$1098

# BOOST PRO FRAME COMPONENTS + HEIGHT-ADJUSTABLE

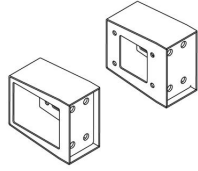
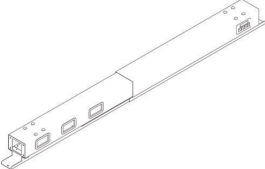
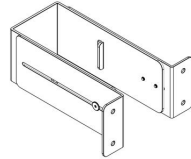
IMAGE	CODE	DESCRIPTION	LIST
	<b>BPROSRB</b> <b>BLK, SLV, WHT</b>	BOOST Pro Power Beam Mounting Brackets, Set of 2 [For Single-Sided Workstations] <b>W 2.38" D 4.63" H 3.94"</b>	\$103
	<b>KIT-BPROTPB</b> <b>BLK, SLV, WHT</b>	BOOST Pro Expandable Power Beam and Data Tray [Includes Faceplates, Trim Plates, and Covers For Cutouts] <b>W 42.63"-60.63" D 4" H 2.88"</b>	\$578

IMAGE	CODE	DESCRIPTION	LIST
Hardware 	<b>BPROAEPB</b> <b>BLK, SLV, WHT</b>	BOOST Pro Adjustable Panel Bracket, Set of 2 [For Laminate Panels] <b>W 6.85"-11.30" D 2.76" H 4.60"</b>	\$243

# BOOST PRO PANELS + WIRE MANAGEMENT

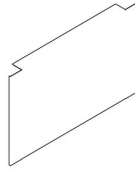


IMAGE	CODE	DESCRIPTION	LIST
Steel End Panel 	BPROEP BLK, SLV, WHT	BOOST Pro Steel End Panel W 30.63" D 2.36" H 18.54"	\$124

IMAGE	CODE	DESCRIPTION	LIST
Infeed Management 	KIT-BPROPP3 BLK, SLV, WHT	144" Power Pole, 3-Piece [For Boost Pro, Includes bracket and Trim Plate] W 3.18" D 1.6" H 144"	\$438
	KIT-BPROPP4 BLK, SLV, WHT	144" Power Pole, 2-Piece [For Boost Pro, Includes bracket and Trim Plate] W 3.18" D 1.6" H 144"	\$438

# HELIX BEAM-MOUNTED DIVIDERS + BRACKETS

IMAGE	CODE	DESCRIPTION	LIST
Divider Supports	IBBMDCLP BLK, SLV, WHT	Helix Integrated Benching Beam-Mounted Divider Clippers, Set of 2 W 2.56" D 2.0" H 4.72"	\$155
	IBDVGS BLK, SLV, WHT	Helix Integrated Benching Divider Clippers Sleeve for Glass & Acrylic, Set of 2 W 2.56" D 1.8" H 4.39"	\$55

IMAGE	CODE	DESCRIPTION	LIST
	IB90CBGEP BLK, SLV, WHT	Helix Integrated Benching 90 degree Column Bracket for Gallery End Panel, Set of 2 W 5.94-8.65 D 5.5 H 2.7	\$130
	IBBBGEP BLK, SLV, WHT	Helix Integrated Benching Butterfly Bracket for Gallery End Panel W 16.5 D 5.4 H 17.9	\$130

# HELIX FRAME COMPONENTS

IMAGE	CODE	DESCRIPTION	LIST
Accessories	IBDRACS24 CYN, FRN, HRB, SHL	Helix Double Run Colored Sleeve for 24" depth [Includes 4 Column & 2 Crossbeam Sleeves]	\$815
	IBDRACS30 CYN, FRN, HRB, SHL	Helix Double Run Colored Sleeve for 30" depth [Includes 4 Column & 2 Crossbeam Sleeves]	\$840
	IBSRACS24 CYN, FRN, HRB, SHL	Helix Single Run Colored Sleeve for 24" depth [Includes 2 Column & 2 Crossbeam Sleeves]	\$515
	IBSRACS30 CYN, FRN, HRB, SHL	Helix Single Run Colored Sleeve for 30" depth [Includes 2 Column & 2 Crossbeam Sleeves]	\$540
Frame Components	IBDRCB24 BLK, SLV, WHT	Helix Integrated Benching Double Run Beam Mounting Crossbars for 24" depth, Set of 2 W 24.9" D 2.18" H 4.5"	\$340
	IBDRCB30 BLK, SLV, WHT	Helix Integrated Benching Double Run Beam Mounting Crossbars for 30" depth, Set of 2 W 30.9" D 2.18" H 4.5"	\$350
	IBHAF BLK, SLV, WHT	Helix Integrated Benching HA Frame with Columns, Stretcher bar, Cantilevers, Standoffs & Handset W 46"-82" D 21.75"	\$1515
	IBLSAF BLK, SLV, WHT	Helix Integrated Benching L-Shape Adapter Kit with Column, Stretcher, Cantilever & Control box W 36.25" D 21.75"	\$1025
	IBMCT4860 BLK, SLV, WHT	Helix Integrated Benching Magnetic Cable Tray for 48"-60" Workstations	\$150

IMAGE	CODE	DESCRIPTION	LIST
	IBMCT7284 BLK, SLV, WHT	Helix Integrated Benching Magnetic Cable Tray for 72"-84" Workstations	\$175
	IBPBCB BLK, SLV, WHT	Helix Integrated Benching Power Beam Connecting Bridge W 11.25" D 3.25" H 4.5"	\$80
	IBPWB4860 BLK, SLV, WHT	Helix Integrated Benching Expandable Power Beam for 48"-60" Workstations with Covers W 37"-49" D 3.25" H 4.5"	\$460
	IBPWB7284 BLK, SLV, WHT	Helix Integrated Benching Expandable Power Beam for 72"-84" Workstations with Covers W 55"-73" D 3.25" H 4.5"	\$505
	IBSRCB24 BLK, SLV, WHT	Helix Integrated Benching Single Run Beam Mounting Crossbars for 24" depth, Set of 2 W 14.6" D 2.18" H 4.5"	\$340
	IBSRCB30 BLK, SLV, WHT	Helix Integrated Benching Single Run Beam Mounting Crossbars for 30" depth, Set of 2 W 20.6" D 2.18" H 4.5"	\$350
	IBSTR7284 BLK, SLV, WHT	Helix Integrated Benching Extended Stretcher bar for 72" - 84" Workstations, Set of 2 W 55.89" D 1.75" H 1.35"	\$135
	IBTLF24 BLK, SLV, WHT	Helix Integrated Benching T-Leg Feet for 24" Deep Workstations, Set of 2 W 23.62" D 3.15" H 1.43"	\$265
	IBTLF30 BLK, SLV, WHT	Helix Integrated Benching T-Leg Feet for 30" Deep Workstations, Set of 2 W 29.62" D 3.15" H 1.43"	\$295

# HELIX POWER

IMAGE	CODE	DESCRIPTION	LIST
Wire Management	IBFCBTK BLK, SLV, WHT	Helix Integrated Benching Forward Cable Tray Kit for Power Beam W 14.17" D 6.14" H .63"	\$110
	PWPL12 BLK, SLV, WHT	12' Power Pole with Bridge for Power Beam Attachment W 7.18" D 3.54" H 144"	\$735

# DELTA ACCESSORIES + FIXED HEIGHT

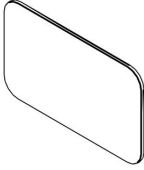
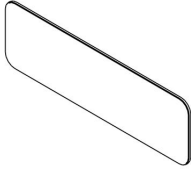
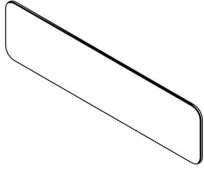
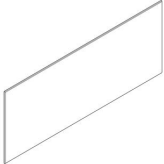
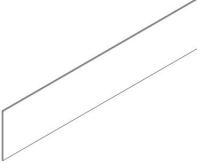
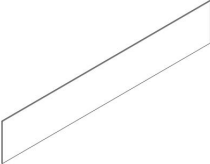
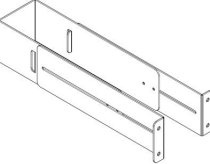
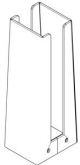
IMAGE	CODE	DESCRIPTION	LIST
Tackboards 	TBRC1830 BLU, GRY	30" Tackboard with Rounded Corners, Velcro for Mounting W 30" D 0.5" H 18"	\$172
	TBRC1830-FX/COM FX-Mayer or COM	30" Tackboard with Rounded Corners, Velcro for Mounting - FX/COM W 30" D 0.5" H 18"	\$215
	TBRC1859 BLU, GRY	59" Tackboard with Rounded Corners, Velcro for Mounting W 59" D 0.5" H 18"	\$205
	TBRC1859-FX/COM FX-Mayer or COM	59" Tackboard with Rounded Corners, Velcro for Mounting - FX/COM W 59" D 0.5" H 18"	\$317
	TBRC1871 BLU, GRY	71" Tackboard with Rounded Corners, Velcro for Mounting W 71" D 0.5" H 18"	\$248
	TBRC1871-FX/COM FX-Mayer or COM	71" Tackboard with Rounded Corners, Velcro for Mounting - FX/COM W 71" D 0.5" H 18"	\$367

IMAGE	CODE	DESCRIPTION	LIST
Hardware 	DLSB BLACK	DELTA Long Structural Support Bracket for Laminate Surfaces, Set of 2 W 2" D 18" H 8"	\$251
	DSSB BLACK	DELTA Short Side Support Bracket for Laminate Surfaces, Set of 4 W 2" D 3" H 3"	\$171
Power 	DFHPM BLK	Delta Fixed Height Power Mounting Bracket W 2.75" D 19.09" H 2.63"	\$74

# DELTA GLASS + HEIGHT-ADJUSTABLE

IMAGE	CODE	DESCRIPTION	LIST
<p>13" High</p>  <p>ADD 3 BSB9 BRACKETS</p>	B12GS70 Dry Erase Frosted Glass	71" Dry-Erase Frosted Glass Divider [13" High] W 71" D 0.31" H 13"	\$748
Glass Panel	PG9	Plastic Gasket for BSB9 W 1" D 1" H 1"	\$1

IMAGE	CODE	DESCRIPTION	LIST
	B12GS33 Dry Erase Frosted Glass	33" Dry Erase Frosted Glass Divider [13" High] W 33" D .313" H 12"	\$360
	B12GS59 Dry Erase Frosted Glass	59" Dry Erase Frosted Glass Divider [13" High] W 59" D .313" H 12"	\$626
	B12GS74 Dry Erase Frosted Glass	74" Dry Erase Frosted Glass Divider [13" High] W 74" D .313" H 12"	\$748
Hardware	BPROAEPB BLK, SLV, WHT	BOOST Pro Adjustable Panel Bracket, Set of 2 [For Laminate Panels] W 6.85"-11.30" D 2.76" H 4.60"	\$243
	BPROLAEPB BLK, SLV, WHT	Boost Pro Long Adjustable Panel Brackets [Set of 2] W 10"-18.19" D 2.76" H 4.60"	\$113
	BPROLPC BLK, SLV, WHT	Boost Pro Laminate Panel Clippers [Set of 2] W 3.62" D 2.91" H 9.45"	\$153

# DELTA HEIGHT-ADJUSTABLE

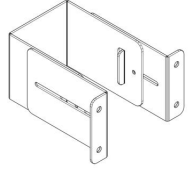
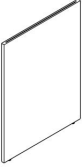
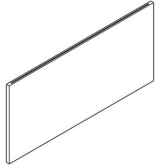
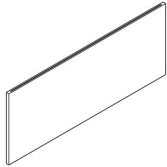
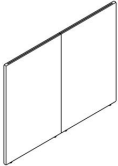
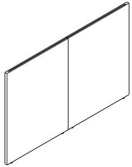
IMAGE	CODE	DESCRIPTION	LIST
	BPROSAEPB BLK, SLV, WHT	Boost Pro Short Adjustable Panel Brackets [Set of 2] W 4.0"-6.9" D 2.76" H 4.60"	\$113
Laminate Panel 	DEND.4836 ELM, OAK, SAH	Delta End Panel for Return Leg [48x36] W 36" D 1" H 48"	\$747
	DFRO.2962 ELM, OAK, SAH	Delta Front Panel Power Beam Mounted [29x62] W 62" D 1" H 29"	\$819
	DFRO.2974 ELM, OAK, SAH	Delta Front Panel Power Beam Mounted [29x74] W 74" D 1" H 29"	\$1075
	DFRO.4862-K ELM, OAK, SAH	Delta Front Panel Floor Modesty, 2-Piece [48x62] W 62" D 1" H 48"	\$1130
	DFRO.4874-K ELM, OAK, SAH	Delta Front Panel Floor Modesty, 2-Piece [48x74] W 74" D 1" H 48"	\$1254

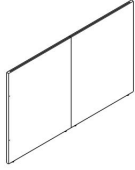
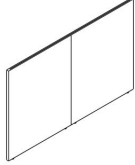
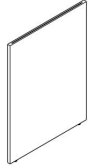
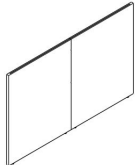
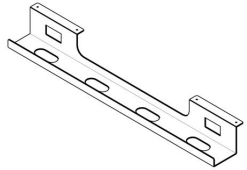
IMAGE	CODE	DESCRIPTION	LIST
	DRET.4877FA-K ELM, OAK, SAH	Delta Return Panel for Facing Stations, 2-Piece [48x77] W 77" D 1" H 48"	\$1382
	DRET.4877SI-K ELM, OAK, SAH	Delta Return Panel for Side-Side Stations, 2-Piece [48x77] W 77" D 1" H 48"	\$1372
	DSID.4836SI ELM, OAK, SAH	Delta Side Panel for Side-Side Stations [48x36] W 36" D 1" H 48"	\$747
	DSID.4877FA-K ELM, OAK, SAH	Delta Side Panel for Facing Stations, 2-Piece [48x77] W 77" D 1" H 48"	\$1330

IMAGE	CODE	DESCRIPTION	LIST
<p data-bbox="136 358 404 393">Under-Surface Wire</p> 	<p data-bbox="459 358 574 393">BWM36</p> <p data-bbox="459 393 637 413">BLK, SLV, WHT</p>	<p data-bbox="801 358 1243 393">Benching Wire Manager, 36" Wide</p> <p data-bbox="801 393 1087 433">W 36" D 5.16" H 4.06"</p>	<p data-bbox="1299 358 1367 393">\$125</p>

# EDGE DESKS

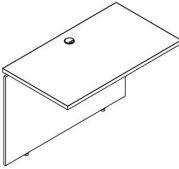
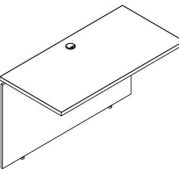
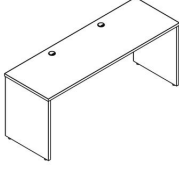
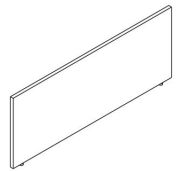
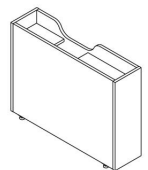
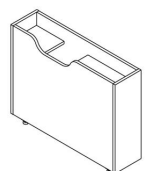
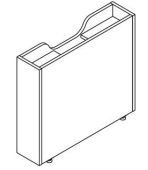
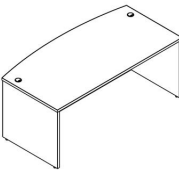
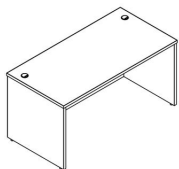
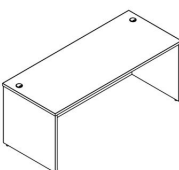
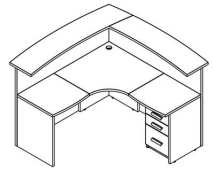
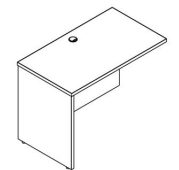
IMAGE	CODE	DESCRIPTION	LIST
Bridges 	EGF2441 ELM, OAK, SAH	EDGE 24"x41" Bridge with Full Modesty Panel [Includes 1 Pre-Installed Grommet] W 41" D 24" H 29.44"	\$871
	EGF2447 ELM, OAK, SAH	EDGE 24"x47" Bridge with Full Modesty Panel [Includes 1 Pre-Installed Grommet] W 47" D 24" H 29.44"	\$923
Credenzas 	ECH2472 ELM, OAK, SAH	EDGE 24"x72" Credenza Shell with Half Modesty Panel [Includes 2 Pre-Installed Grommets] W 72" D 23.75" H 29.44"	\$1590
EDGE Height Adjustable Desk 	ESHAFP72 ELM, OAK, SAH	EDGE Fixed Modesty Panel [For 72" Height-Adjustable Workstation]	\$276
	ESHALC.L ELM, OAK, SAH1	EDGE Left-Leg Cover [For Height-Adjustable Workstation]	\$506
	ESHALC.R ELM, OAK, SAH1	EDGE Right-Leg Cover [For Height-Adjustable Workstation]	\$506

IMAGE	CODE	DESCRIPTION	LIST
	ESHARLC ELM1, OAK1, SAH1	EDGE Return-Leg Cover [For Height-Adjustable Workstation]	\$498
Main 	EBDF3571 ELM, OAK, SAH	EDGE 35"x71" Bow-Front Desk Shell with Full Modesty Panel [Includes 2 Pre-Installed Grommets] W 71" D 35" H 29.44"	\$1983
	EDF3059 ELM, OAK, SAH	EDGE 30"x59" Desk Shell with Full Modesty Panel [Includes 2 Pre-Installed Grommets] W 59" D 30" H 29.44"	\$1386
	EDF3071 ELM, OAK, SAH	EDGE 30"x71" Desk Shell with Full Modesty Panel [Includes 2 Pre-Installed Grommets] W 71" D 30" H 29.44"	\$1772
Reception 	ERUHK BLK, WHT	EDGE Reception Unit Hardware W 1.18" D 3.93" H 3.93"	\$0.01
	KIT-ERUBBF ELM, OAK, SAH, WHT	EDGE Reception Unit [Includes Transaction Counter and BBF Pedestal] W 66.88" D 66.88" H 45"	\$6972
Returns 	ERF2441.L ELM, OAK, SAH	EDGE 24"x41" Left-Hand Return with Full Modesty Panel [Includes 1 Pre-Installed Grommet] W 41" D 24" H 29.44"	\$1099

# EDGE DESKS + FAST PROGRAM

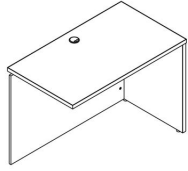
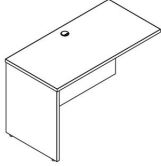
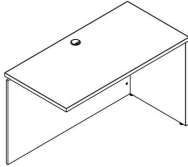
IMAGE	CODE	DESCRIPTION	LIST
	ERF2441.R ELM, OAK, SAH	EDGE 24"x41" Right-Hand Return with Full Modesty Panel [Includes 1 Pre-Installed Grommet] W 41" D 24" H 29.44"	\$1099
	ERF2447.L ELM, OAK, SAH	EDGE 24"x47" Left-Hand Return with Full Modesty Panel [Includes 1 Pre-Installed Grommet] W 47" D 24" H 29.44"	\$1117
	ERF2447.R ELM, OAK, SAH	EDGE 24"x47" Right-Hand Return with Full Modesty Panel [Includes 1 Pre-Installed Grommet] W 47" D 24" H 29.44"	\$1117

IMAGE	CODE	DESCRIPTION	LIST
Accessories 	EFS1429 ELM, OAK, SAH	EDGE 14"x29" Floating Shelf W 29" D 15" H 14"	\$582
	EFS1471 ELM, OAK, SAH	EDGE 14"x71" Floating Shelf W 71" D 15" H 14"	\$1285
Pedestals 	ELMBF ELM, OAK, SAH, WHT	EDGE Laminate Mobile Box File W 16.14" D 17.71" H 23.37"	\$907

# EDGE HEIGHT-ADJUSTABLE + STORAGE

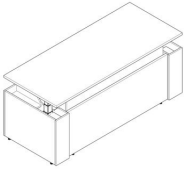
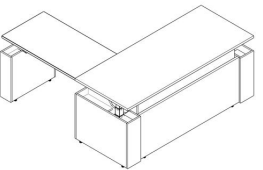
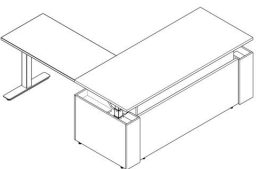
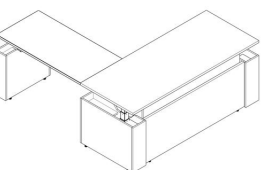
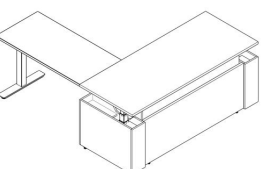



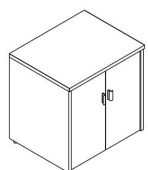
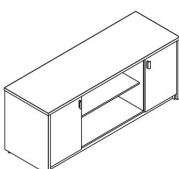
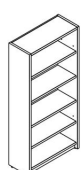
IMAGE	CODE	DESCRIPTION	LIST
TYPICALS 	EHAD3072 ELM, OAK, SAH	EDGE Height Adjustable Straight Desk [30" x 72"] W 72" D 30" H 25.4"-51"	\$4462
	EHAD3072L2442 ELM, OAK, SAH	EDGE Height Adjustable Desk [30" x 72" w/ 24" x 42" Return] W 72" D 72" H 25.4"-51"	\$6595
	EHAD3072L2442-NRLC ELM, OAK, SAH	EDGE Height Adjustable Desk [30" x 72" w/ 24" x 42" Return, No Return Leg Cover] W 72" D 72" H 25.4"-51"	\$6097
	EHAD3072L2448 ELM, OAK, SAH	EDGE Height Adjustable Desk [30" x 72" w/ 24" x 48" Return] W 72" D 78" H 25.4"-51"	\$6641
	EHAD3072L2448-NRLC ELM, OAK, SAH	EDGE Height Adjustable Desk [30" x 72" w/ 24" x 48" Return, No Return Leg Cover] W 72" D 78" H 25.4"-51"	\$6143

IMAGE	CODE	DESCRIPTION	LIST
Free-Standing 	E2DLF ELM, OAK, SAH	EDGE 30" Laminate 2-Drawer Lateral File [29" High] W 29.68" D 24.71" H 29.44"	\$2885
	E3DWC.L ELM, OAK, SAH	EDGE 33" Left-Hand Laminate 3-Drawer Wardrobe Cabinet [71" High] W 33.22" D 24.79" H 70.82"	\$4282
	E3DWC.R ELM, OAK, SAH	EDGE 33" Right-Hand Laminate 3-Drawer Wardrobe Cabinet [71" High] W 33.22" D 24.79" H 70.82"	\$4282
	ED2C30 ELM, OAK, SAH	EDGE 30" Laminate 2-Door Cabinet [29" High] W 29.68" D 24.28" H 29.44"	\$2015
	ED2CS ELM, OAK, SAH	EDGE 72" Laminate 2-Door Credenza with Open Shelf [30" High] W 71.02" D 24.57" H 29.13"	\$3638
	ELB1471 ELM, OAK, SAH	EDGE 33" Laminate 5-High Bookcase [71" High] W 33" D 14" H 71"	\$2479

# EDGE STORAGE

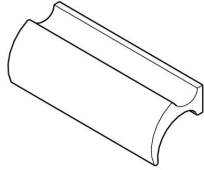
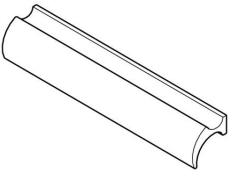
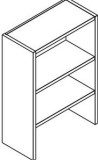
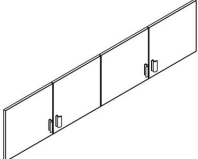
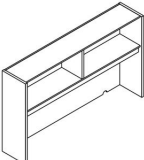
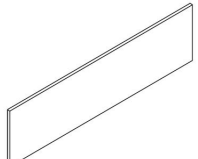
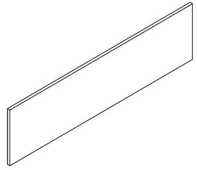


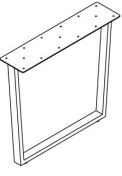
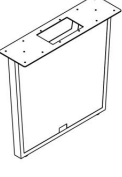
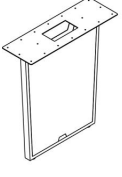
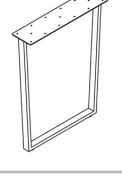

IMAGE	CODE	DESCRIPTION	LIST
Hardware 	LRP3 BLK, SLV, WHT	Laminite Storage Replacement Pull 3" W 3" D 1.13" H 1"	\$30
	LRP6 BLK, SLV, WHT	Laminite Storage Replacement Pull 6" W 6" D 1.13" H 1"	\$30
Hutches 	E2SH ELM, OAK, SAH	EDGE 29" Laminite 2-Shelf Open Hutch [41" High] W 28.75" D 13.87" H 41.31"	\$1833
	EDK70 ELM, OAK, SAH	EDGE Laminite Hutch Door Kit, Set of 4 [16.5" High, For 70" Open Hutch] W 16.81" D 0.63" H 16.5"	\$522
	EH70S ELM, OAK, SAH	EDGE 70" Laminite Open Hutch [41" High] W 70.07" D 13.85" H 41.33"	\$3552
	GBT1868 BLU, GRY, TPE	68" Fabric Tackboard [18" High] W 68" H 18"	\$588

IMAGE	CODE	DESCRIPTION	LIST
	GBT1868.FXCOM FX-Mayer or COM	68" Fabric Tackboard [18" High, Requires 2.5 Yards] - FX/COM W 68" H 18"	\$1048
Surface-Supporting 	EBBFSS ELM, OAK, SAH	EDGE Laminite Box/Box/File Surface-Supporting Pedestal W 15.94" D 18.68" H 28.34"	\$1520
	EFFSS ELM, OAK, SAH	EDGE Laminite File/File Surface-Supporting Pedestal W 15.94" D 18.68" H 28.34"	\$1434

# THREE60 BASES + LEGS

IMAGE	CODE	DESCRIPTION	LIST
 <p>Cabinet Base</p>	<p>CNCBV2 ELM, WHT, BLK, OAK, SAH</p>	<p>THREE60 Cabinet Base (V2) - FAST W 17.72" D 11.81" H 27.36"</p>	<p>\$702</p>

IMAGE	CODE	DESCRIPTION	LIST
<p>Legs</p> 	<p>GCNAB BLK, SLV, WHT</p>	<p>THREE60 Angled Sleigh Leg W 30" D 7.28" H 27.36"</p>	<p>\$844</p>
	<p>GCNABCOV BLK, SLV, WHT</p>	<p>THREE60 Angled Sleigh Leg [Covered For Wire Management] W 30" D 7.28" H 27.36"</p>	<p>\$930</p>
<p>Standing-Height Legs</p> 	<p>GCNABCOVSH BLK, SLV, WHT</p>	<p>THREE60 Standing-Height Angled Sleigh Leg [Covered For Wire Management] W 35" D 11.81" H 38.39"</p>	<p>\$1201</p>
	<p>GCNABSHV2 BLK, SLV, WHT</p>	<p>THREE60 Standing-Height Angled Sleigh Leg (V2) W 30" D 7.28" H 38.39"</p>	<p>\$978</p>
<p>Support Brace</p> 	<p>GCNABSHLE BLK, SLV, WHT</p>	<p>THREE60 Support Brace [For Standing-Height Angled Sleigh Leg] W 3" D 26.34" H 38.11"</p>	<p>\$287</p>

# THREE60 SURFACES

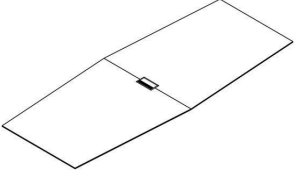
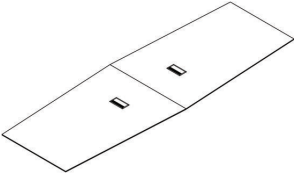
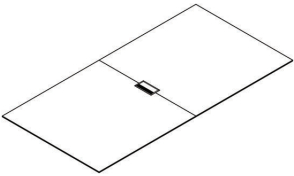
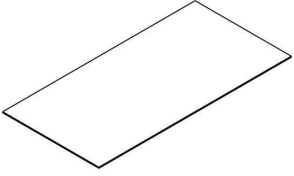
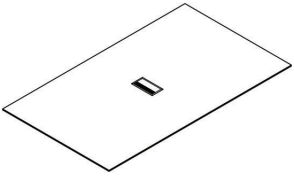
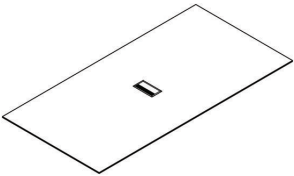
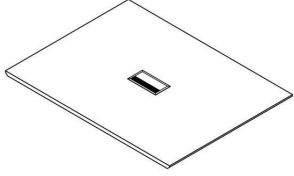
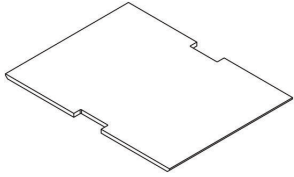
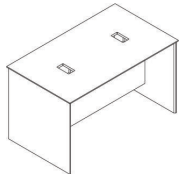
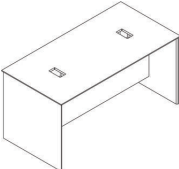
IMAGE	CODE	DESCRIPTION	LIST
2-Piece 	CNS48120 ELM, OAK, SAH, WHT	THREE60 48"x120" Trapezoid Surface, 2-Piece [Includes Knife Edge & 1 Grommet] - FAST W 120" D 48" H 1"	\$1841
	CNS48144 ELM, OAK, SAH, WHT	THREE60 48"x144" Trapezoid Surface, 2-Piece [Includes Knife Edge & 2 Grommets] - FAST W 144" D 48" H 1"	\$2182
	CNS4896 ELM, OAK, SAH, WHT	THREE60 48"x96" Surface, 2-Piece [Includes Knife Edge & 1 Grommet] - FAST W 96" D 48" H 1"	\$1438
Single Piece 	CNS3672 ELM, OAK, SAH, WHT	THREE60 36"x72" Surface [Includes Knife Edge] - FAST W 72" D 36" H 1"	\$765
	CNS4272 ELM, OAK, SAH, WHT	THREE60 42"x72" Surface [Includes Knife Edge & 1 Grommet] - FAST W 72" D 42" H 1"	\$958
	CNS4284 ELM, OAK, SAH, WHT	THREE60 42"x84" Surface [Includes Knife Edge & 1 Grommet] - FAST W 84" D 42" H 1"	\$1150

IMAGE	CODE	DESCRIPTION	LIST
Spacers 	CNCGB ELM, OAK, SAH, WHT	THREE60 48"x36" Center-Grommet Spacer Surface [Includes Knife Edge & 1 Grommet] - FAST W 36" D 48" H 1"	\$594
	CNSGA ELM, OAK, SAH, WHT	THREE60 48"x36" Split-Grommet Spacer Surface [Includes Knife Edge & 2 Half-Cutouts & 1 Grommet] - FAST W 36" D 48" H 1"	\$616

# THREE60 TABLES

IMAGE	CODE	DESCRIPTION	LIST
	KIT-CPT4272 ELM, OAK, SAH, WHT	THREE60 42"x72" Parsons Table [Includes 2 Grommets] - FAST W 72" D 42" H 41.5"	\$2681
	KIT-CPT4284 ELM, OAK, SAH, WHT	THREE60 42"x84" Parsons Table [Includes 2 Grommets] - FAST W 84" D 42" H 41.5"	\$2931

# OPTIMA FRAMES + PANELS




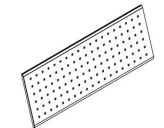
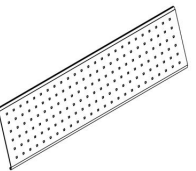
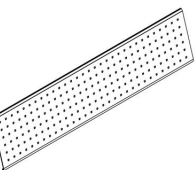
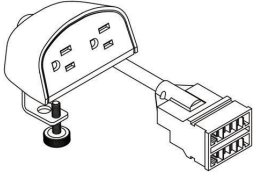
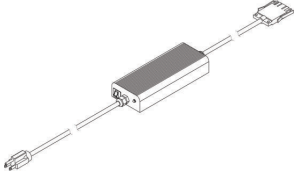
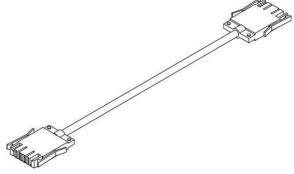
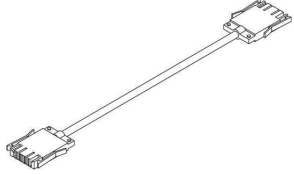
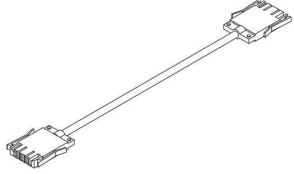
IMAGE	CODE	DESCRIPTION	LIST
	PTT48 BLK, SLV	OPTIMA 48" Training Table Frame W 46.7" D 23.0" H 28.5"	\$955
	PTT60 BLK, SLV	OPTIMA 60" Training Table Frame W 58.7" D 23.0" H 28.5"	\$1015
	PTT72 BLK, SLV	OPTIMA 72" Training Table Frame W 70.7" D 23.0" H 28.5"	\$1060

IMAGE	CODE	DESCRIPTION	LIST
Modesty Panels 	PSMP48 BLK, SLV	OPTIMA Steel Modesty Panel [For 48" Training Table] W 41.0" D 0.5" H 13.8"	\$310
	PSMP60 BLK, SLV	OPTIMA Steel Modesty Panel [For 60" Training Table] W 51.5" D 0.5" H 13.8"	\$340
	PSMP72 BLK, SLV	OPTIMA Steel Modesty Panel [For 72" Training Table] W 63.0" D 0.5" H 13.8"	\$380

# OPTIMA POWER

IMAGE	CODE	DESCRIPTION	LIST
<p>Desktop</p> 	<p>PSMA BLK</p>	<p>OPTIMA Desktop Power Unit [2 Outlets, 24" Cord] W 3.5" D 2.5" H 2"</p>	<p>\$393</p>
<p>Infeed</p> 	<p>PSPIF144 BLK</p>	<p>OPTIMA 114" In-Feed W 114" D 0.75" H 1.75"</p>	<p>\$1387</p>
<p>Jumpers</p> 	<p>PSJ48 BLK</p>	<p>OPTIMA 48" Jumper [For 48" Table] W 48" D 0.75" H 1.75"</p>	<p>\$178</p>
	<p>PSJ60 BLK</p>	<p>OPTIMA 60" Jumper [For 60" Table] W 60" D 0.75" H 1.75"</p>	<p>\$208</p>
	<p>PSJ72 BLK</p>	<p>OPTIMA 72" Jumper [For 66" &amp; 72" Tables] W 72" D 0.75" H 1.75"</p>	<p>\$219</p>

# COVE PODS

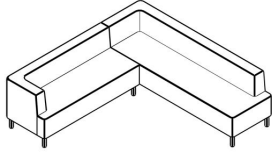

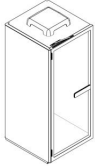

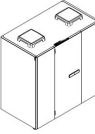
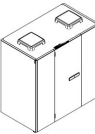
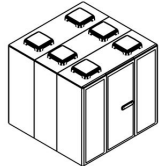
IMAGE	CODE	DESCRIPTION	LIST
	CPSS-GRC <b>Gray Combo</b>	COVE Pod Sofa Set [for CPRM]-Gray <b>W 87.25" D 85" H 27.5"</b>	\$3100
	CVFPL-MBK <b>MBK</b>	Cove Focus Pod Lite [Includes Power, Surface, Lighting, HEPA Filter, and Occupancy Sensor] <b>W 39.375" D 40.938" H 85.813"</b>	\$21168
	CVFPOP-MBK <b>MBK, MWT</b>	COVE Focus Pod [Includes Power, Surface, Lighting, Motion Sensor]-Matte Black <b>W 39.375" D 40.938" H 85.813"</b>	\$23603
	CVFPOP-MWT <b>MBK, MWT</b>	COVE Focus Pod [Includes Power, Surface, Lighting, Motion Sensor]-Matte White <b>W 39.375" D 40.938" H 85.813"</b>	\$23603
	CVMPTP-MBK <b>MBK, MWT</b>	COVE Meeting Pod [Includes Power, Surface, Lighting, Motion Sensor, High-Back Seats]-Matte Black <b>W 86.625" D 50.5" H 85.813"</b>	\$42278
	CVMPTP-MWT <b>MBK, MWT</b>	COVE Meeting Pod [Includes Power, Surface, Lighting, Motion Sensor, High-Back Seats]-Matte White <b>W 86.625" D 50.5" H 85.813"</b>	\$42278
	CVRP-MBK <b>MBK, MWT</b>	COVE Room Pod [Includes Power, Lighting, Motion Sensor, TV Mount]-Matte Black <b>W 94.5" D 95.563" H 85.625"</b>	\$76980

IMAGE	CODE	DESCRIPTION	LIST
	CVRP-MWT <b>MBK, MWT</b>	COVE Room Pod [Includes Power, Lighting, Motion Sensor, TV Mount]-Matte White <b>W 94.5" D 95.563" H 85.625"</b>	\$76980

# KOLAB LOUNGE SEATING

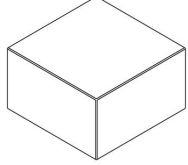
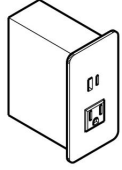
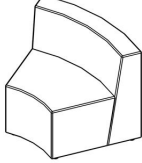
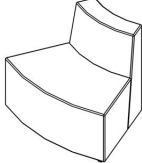
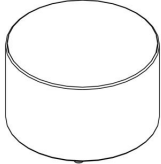
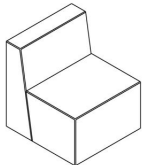
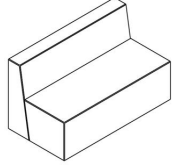
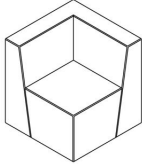
IMAGE	CODE	DESCRIPTION	LIST
Ottomans 	KBSQ GST, STM	KOLAB Square Ottoman - FAST W 29" D 29" H 18"	\$885
Power 	KPUAC BLK, WHT	Inset Power Unit [1 Power Outlet, USB A+C, 72" Cord]	\$655
Segments 	KBIC GST, STM	Kolab Inward Curve W 29" D 29" H 18"	\$1749
	KBOC GST, STM	Kolab Outward Curve Segment W 29" D 29" H 18"	\$1843
	KBRO GST, STM	Kolab Round Ottoman W 29" D 29" H 18"	\$1230
	KBS1 GST, STM	KOLAB Single Segment - FAST W 27.5" D 29" H 32"	\$1119

IMAGE	CODE	DESCRIPTION	LIST
	KBS2 GST, STM	KOLAB 2-Seat Segment - FAST W 55" D 29" H 32"	\$1744
	KBSC GST, STM	KOLAB Corner Segment - FAST W 29" D 29" H 32"	\$1464

# SEATING ACCESSORIES + CONFERENCE CHAIRS

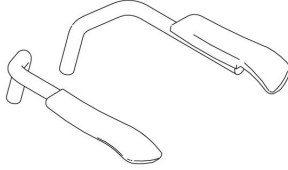
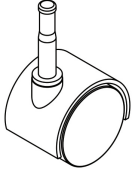
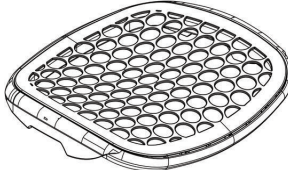
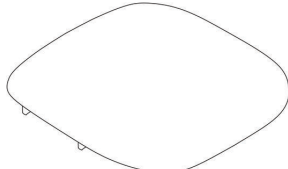
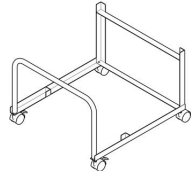

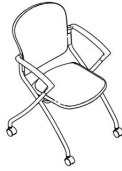
IMAGE	CODE	DESCRIPTION	LIST
	N33AR BLK	Blaze Armrest Kit, Set of 2	\$59
	N33CI2 BLK	Blaze Caster Kit, Set of 4 (V2) W 1.85" D 1.5" H 1.87"	\$34
	N33MS BLK	Blaze Mesh Seat W 18" D 17.25" H 3"	\$171
	N33SC BLK	Blaze Cushion Seat W 18" D 18.25" H 3"	\$171
	N33SC.UPH	Blaze Cushion Seat Reupholstery [Requires 1 Yard] - FX/COM	\$408
	NM33A BLK	Blaze Chair Trolley [Stacks 25 Chairs] W 23.25" D 21.75" H 16"	\$448

IMAGE	CODE	DESCRIPTION	LIST
	N977 BLK, COG, GRY	Vogue (Mid-Back) [Conference Chair] W 22" D 26" H 36"-39"	\$1053
	N979 BLK, COG, GRY	Vogue (High-Back) [Conference Chair] W 22" D 26" H 17"-19.5"	\$1074

# SEATING


## Collaborative + NESTING CHAIRS

IMAGE	CODE	DESCRIPTION	LIST
	O9000-BLK CLD, ECL	ORBIS Collaborative Chair [Black Seat Base]	\$840
	O9000-CHR CLD, ECL	ORBIS Collaborative Chair [Chrome Seat Base]	\$840
	O9000-WHT CLD, ECL	ORBIS Collaborative Chair [White Seat Base]	\$740
	P9000-BLK ALY, BLK, CBN, CYN, Cern, HRB, IRS, LIN, LUN, SHL, TWL, BLK-V	PIVOT Collaborative Chair [Black Chair Base]	\$690
	P9000-WHT ALY, BLK, CBN, CYN, Cern, HRB, IRS, LIN, LUN, SHL, TWL, BLK-V	PIVOT Collaborative Chair [White Chair Base]	\$725
	P9000DK	PIVOT Draft Kit [Foot Rest Ring and Extended Cylinder]	\$190

IMAGE	CODE	DESCRIPTION	LIST
	N2000 BLK	Ice [Nesting Chair, Includes Casters and Arms] W 22" D 23" H 31"	\$439
	N2000.UPH	Ice Seat Reupholstery [Requires 0.75 Yards] - FX/COM	\$293



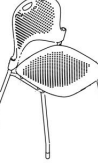

# SEATING Nesting + SIDE CHAIRS

IMAGE	CODE	DESCRIPTION	LIST
	T2000-BLK ALY, BLK, CBN, CYN, Cern, HRB, IRS, LIN, LUN, SHL, TWL	TONIC Nesting Chair [Black Chair Base]	\$560
	T2000-GRY ALY, BLK, CBN, CYN, Cern, HRB, IRS, LIN, LUN, SHL, TWL	TONIC Nesting Chair [Grey Chair Base]	\$560
	T2000-WHT ALY, BLK, CBN, CYN, Cern, HRB, IRS, LIN, LUN, SHL, TWL	TONIC Nesting Chair [White Chair Base]	\$560

IMAGE	CODE	DESCRIPTION	LIST
	N899 BLK	Kule 2 [Side Chair, Includes Arms] W 23" D 25" H 34"	\$372
	N899.UPH	Kule 2 Seat Reupholstery [Requires 0.75 Yards] - FX/COM	\$293
	V899 BLK, GRY	The Vapor [Side Chair, includes Arms] W 23.5 D 23.5 H 35.75	\$814

# SEATING STACKING CHAIRS

IMAGE	CODE	DESCRIPTION	LIST
	KFCHB.B AMO, BLK, WAL, OGY, WHT	KIVA Counter Stool (High Back) with Black Frame W 18.5 D 19 H 33.5	\$626
	KFCHB.C AMO, BLK, WAL, OGY, WHT	KIVA Counter Stool (High Back) with Chrome Frame W 18.5 D 19 H 33.5	\$626
	KFCHR.B AMO, BLK, WAL, OGY, WHT	KIVA Chair with Black Frame W 18.5 D 19 H 33.5	\$492
	KFCHR.C AMO, BLK, WAL, OGY, WHT	KIVA Chair with Chrome Frame W 18.5 D 19 H 33.5	\$492
	KFCLB.B AMO, BLK, WAL, OGY, WHT	KIVA Counter Stool (Low Back) with Black Frame W 18.5 D 19 H 33.5	\$604
	KFCLB.C AMO, BLK, WAL, OGY, WHT	KIVA Counter Stool (Low Back) with Chrome Frame W 18.5 D 19 H 33.5	\$604
	KFHBS.C AMO, BLK, WAL, OGY, WHT	KIVA Barstool (High Back) with Chrome Frame W 18.5 D 19 H 33.5	\$626

IMAGE	CODE	DESCRIPTION	LIST
	KFLBS.C AMO, BLK, WAL, OGY, WHT	KIVA Barstool (Low Back) with Chrome Frame W 18.5 D 19 H 33.5	\$604
	N33BH BLK, BLU, CTR, WHT	Blaze (Bar Stool) [Armless Stackable Stool] W 23.25" D 25.38" H 45.25"	\$717
	N33PK BLK, BLU, CTR, WHT	Blaze [Armless Stackable Chair, Includes Glides] W 21.25" D 23.25" H 33.5"	\$461
	N899 BLK	Kule 2 [Side Chair, Includes Arms] W 23" D 25" H 34"	\$372
	N899.UPH	Kule 2 Seat Reupholstery [Requires 0.75 Yards] - FX/COM	\$293

# SEATING STOOLS + TASK CHAIRS

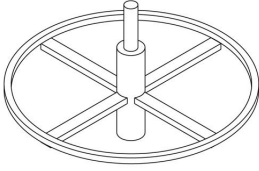







IMAGE	CODE	DESCRIPTION	LIST
	DK2 BLK	Universal Drafting Stool Kit (For Task and Conference Chairs) W 18" D 18" H 8"-14"	\$234
	KFHBS.B AMO, BLK, WAL, OGY, WHT	KIVA Barstool (High Back) with Black Frame W 20.25 D 22 H 45.5	\$626
	KFLBS.B AMO, BLK, WAL, OGY, WHT	KIVA Barstool (Low Back) with Black Frame W 20.25 D 20.5 H 38	\$604
	N33BH BLK, BLU, CTR, WHT	Blaze (Bar Stool) [Armless Stackable Stool] W 23.25" D 25.38" H 45.25"	\$717




IMAGE	CODE	DESCRIPTION	LIST
	N5000 BLK	Epic [Task Chair] W 25" D 23" H 37"-41"	\$684
	N5000.UPH	Epic Seat Reupholstery [Requires 1 Yard] - FX/COM	\$388
	N6000 BLK	Fusion [Task Chair] W 28" D 22" H 36"-40"	\$769
	N6000.UPH	Fusion Seat Reupholstery [Requires 0.75 Yards] - FX/COM	\$388
	N7000 BLK	Razor [Task Chair] W 26" D 24" H 39"-42"	\$1208
	N7000.UPH	Razor Seat Reupholstery [Requires 1 Yard] - FX/COM	\$279
	V402.COM COM	Ventus [Task Chair with COM Seat] W 26.38"-27.56" D 24.21"-26.18" H 40.16"-44.88"	\$1376
	V402.FAST BBBLK, BBCAP, BBCHA, BBPAL, GGBLK, GGCAP, GGCHA, GGPAL, GBBLK, GBCAP, GBCHA, GBPAL	Ventus [Task Chair] W 26.38"-27.56" D 24.21"-26.18" H 40.16"-44.88"	\$1187

# SEATING TASK CHAIRS + Task

IMAGE	CODE	DESCRIPTION	LIST
	V402.FX FX-Mayer	Ventus [Task Chair with FX Seat] W 26.38"-27.56" D 24.21"-26.18" H 40.16"-44.88"	\$1524

IMAGE	CODE	DESCRIPTION	LIST
	A5000-BLK ALY, BLK, CBN, CYN, Cern, HRB, IRS, LIN, LUN, SHL, TWL, BLK-V	APEX Task Chair [Black Chair Base]	\$795
	A5000-WHT ALY, BLK, CBN, CYN, Cern, HRB, IRS, LIN, LUN, SHL, TWL, BLK-V	APEX Task Chair [White Chair Base]	\$875
	A5000DK	APEX Draft Kit [Foot Rest Ring and Extended Cylinder]	\$220
	A5000PB	APEX Task Chair Polished Based and Gas Lift	\$280
	S7000-BLK	SLATE Task Chair [Black Chair]	\$1030
	S7000-WHT	SLATE Task Chair [White Chair]	\$1090
	S7000MS-BLK	SLATE Task Chair [Black Chair, Black Mesh Seat]	\$955
	S7000MS-BLU	SLATE Task Chair [Blue Chair, Blue Mesh Seat]	\$1030
	S7000PB	SLATE Task Chair Polished 5-star Base	\$65
	S7000PC	SLATE Task Chair Polished Cylinder	\$210

IMAGE	CODE	DESCRIPTION	LIST
	KFCHB.B AMO, BLK, WAL, OGY, WHT	KIVA Counter Stool (High Back) with Black Frame W 18.5 D 19 H 33.5	\$626
	KFCHB.C AMO, BLK, WAL, OGY, WHT	KIVA Counter Stool (High Back) with Chrome Frame W 18.5 D 19 H 33.5	\$626
	KFCHR.B AMO, BLK, WAL, OGY, WHT	KIVA Chair with Black Frame W 18.5 D 19 H 33.5	\$492
	KFCHR.C AMO, BLK, WAL, OGY, WHT	KIVA Chair with Chrome Frame W 18.5 D 19 H 33.5	\$492
	KFCLB.B AMO, BLK, WAL, OGY, WHT	KIVA Counter Stool (Low Back) with Black Frame W 18.5 D 19 H 33.5	\$604
	KFCLB.C AMO, BLK, WAL, OGY, WHT	KIVA Counter Stool (Low Back) with Chrome Frame W 18.5 D 19 H 33.5	\$604
	KFHBS.B AMO, BLK, WAL, OGY, WHT	KIVA Barstool (High Back) with Black Frame W 20.25 D 22 H 45.5	\$626

IMAGE	CODE	DESCRIPTION	LIST
	KFHBS.C AMO, BLK, WAL, OGY, WHT	KIVA Barstool (High Back) with Chrome Frame W 18.5 D 19 H 33.5	\$626
	KFLBS.B AMO, BLK, WAL, OGY, WHT	KIVA Barstool (Low Back) with Black Frame W 20.25 D 20.5 H 38	\$604
	KFLBS.C AMO, BLK, WAL, OGY, WHT	KIVA Barstool (Low Back) with Chrome Frame W 18.5 D 19 H 33.5	\$604

# SURFACES FAST PROGRAM

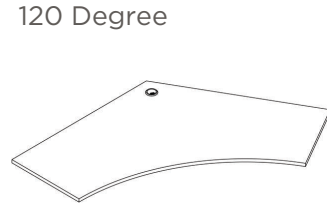
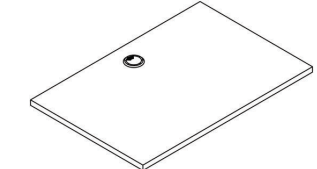
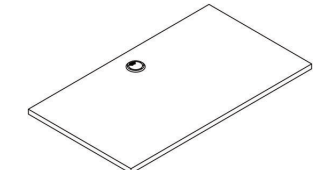
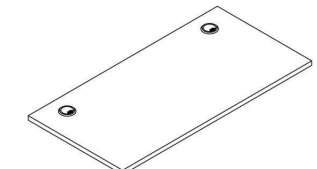
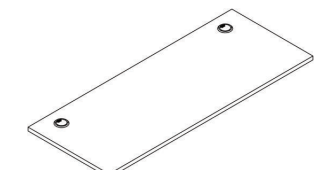
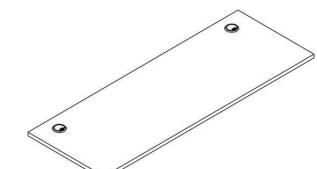
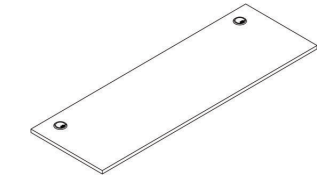
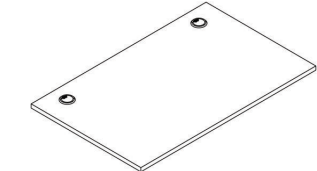
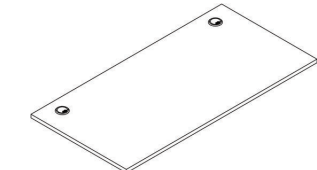
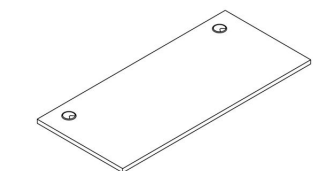
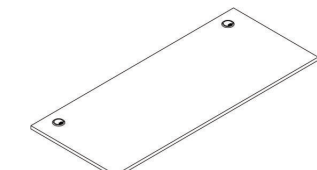
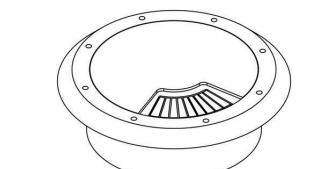
IMAGE	CODE	DESCRIPTION	LIST
 <p>120 Degree</p>	<p>GB120V2 ELM, MPL, OAK, SAH, WHT</p>	<p>120 Degree Surface (V2) [1" Thick, Includes 1 Pre-Installed Grommet] - FAST W 83" D 44.75" H 1"</p>	\$1008
 <p>24" Deep Rectangular</p>	<p>GB2436 ELM, MPL, OAK, SAH, WHT</p>	<p>24"x36" Cross-Grain Surface [1" Thick, Includes 1 Pre-Installed Grommet] - FAST W 36" D 24" H 1"</p>	\$302
	<p>GB2442 ELM, MPL, OAK, SAH, WHT</p>	<p>24"x42" Cross-Grain Surface [1" Thick, Includes 1 Pre-Installed Grommet] - FAST W 42" D 24" H 1"</p>	\$317
	<p>GB2448 ELM, MPL, OAK, SAH, WHT</p>	<p>24"x48" Surface [1" Thick, Includes 2 Pre-Installed Grommets] - FAST W 48" D 24" H 1"</p>	\$363
	<p>GB2460 ELM, MPL, OAK, SAH, WHT</p>	<p>24"x60" Surface [1" Thick, Includes 2 Pre-Installed Grommets] - FAST W 60" D 24" H 1"</p>	\$450
	<p>GB2466 ELM, MPL, OAK, SAH, WHT</p>	<p>24"x66" Surface [1" Thick, Includes 2 Pre-Installed Grommets] - FAST W 66" D 24" H 1"</p>	\$494

IMAGE	CODE	DESCRIPTION	LIST
	<p>GB2472 ELM, MPL, OAK, SAH, WHT</p>	<p>24"x72" Surface [1" Thick, Includes 2 Pre-Installed Grommets] - FAST W 72" D 24" H 1"</p>	\$532
 <p>30" Deep Rectangular</p>	<p>GB3048 ELM, MPL, OAK, SAH, WHT</p>	<p>30"x48" Surface [1" Thick, Includes 2 Pre-Installed Grommets] - FAST W 48" D 30" H 1"</p>	\$450
	<p>GB3060 ELM, MPL, OAK, SAH, WHT</p>	<p>30"x60" Surface [1" Thick, Includes 2 Pre-Installed Grommets] - FAST W 60" D 30" H 1"</p>	\$575
	<p>GB3066 ELM, MPL, OAK, SAH, WHT</p>	<p>30"x66" Surface [1" Thick, Includes 2 Pre-Installed Grommets] - FAST W 66" D 30" H 1"</p>	\$632
	<p>GB3072 ELM, MPL, OAK, SAH, WHT</p>	<p>30"x72" Surface [1" Thick, Includes 2 Pre-Installed Grommets] - FAST W 72" D 30" H 1"</p>	\$660
 <p>Grommet</p>	<p>BLW60 BLK, SLV, WHT</p>	<p>Grommet [60mm] W 2.36" D 2.36" H 0.75"</p>	\$19

# SURFACES

## FAST PROGRAM + FX PROGRAM

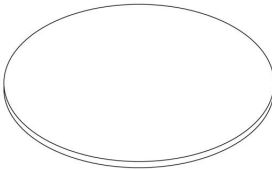
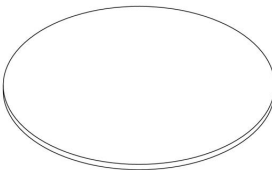
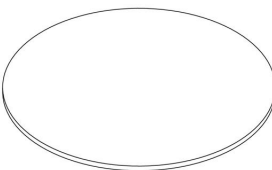
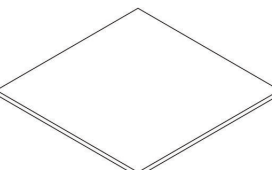
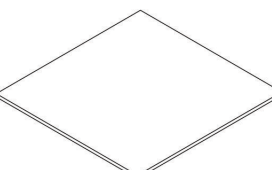
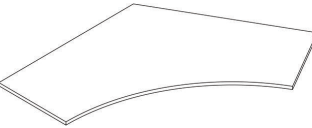
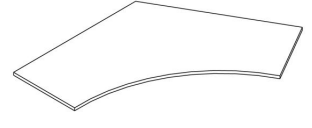
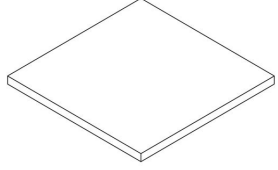
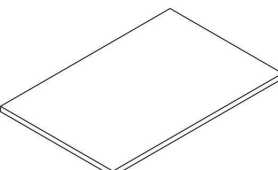
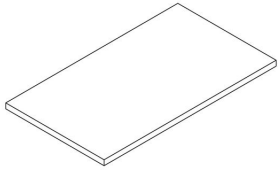
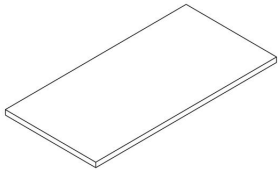
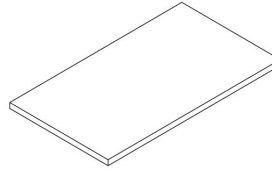
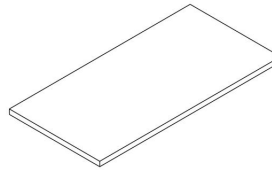
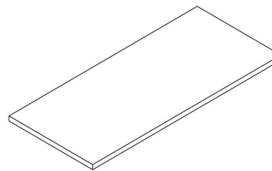
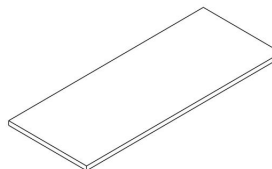
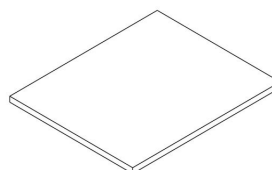
IMAGE	CODE	DESCRIPTION	LIST
Round 	GB360 ELM, MPL, OAK, SAH, WHT	36" Round Surface [1" Thick] - FAST W 36" D 36" H 1"	\$530
	GB420 ELM, MPL, OAK, SAH, WHT	42" Round Surface [1" Thick] - FAST W 42" D 42" H 1"	\$533
	GB480 ELM, MPL, OAK, SAH, WHT	48" Round Surface [1" Thick] - FAST W 48" D 48" H 1"	\$655
Square 	GB3636 ELM, MPL, OAK, SAH, WHT	36"x36" Surface [1" Thick] - FAST W 36" D 36" H 1"	\$521
	GB4849 ELM, MPL, OAK, SAH, WHT	49"x48" Surface [1" Thick] - FAST W 48" D 49" H 1"	\$660

IMAGE	CODE	DESCRIPTION	LIST
120 Degree 	WA48120 FX	120 Degree Surface (48" Sides) - FX W 83" D 44.75" H 1.25"	\$1392
	WA60120 FX	120 Degree Surface (60" Sides) - FX W 104" D 50.75" H 1.25"	\$2335
24" Deep Rectangular 	WA2424 FX	24"x24" Surface - FX W 24" D 24" H 1.25"	\$803
	WA2436 FX	24"x36" Surface - FX W 36" D 24" H 1.25"	\$803
	WA2442 FX	24"x42" Surface - FX W 42" D 24" H 1.25"	\$843
	WA2448 FX	24"x48" Surface - FX W 48" D 24" H 1.25"	\$869

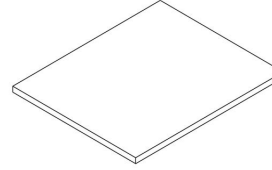
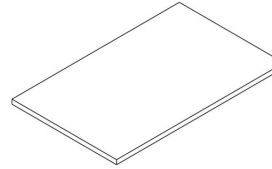
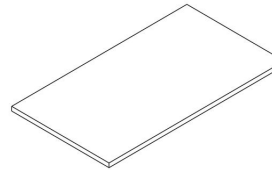
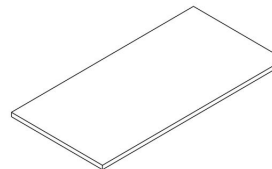
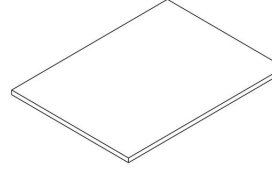
# SURFACES FX PROGRAM

IMAGE	CODE	DESCRIPTION	LIST
	WA2454 FX	24"x54" Surface - FX W 54" D 24" H 1.25"	\$970
	WA2460 FX	24"x60" Surface - FX W 60" D 24" H 1.25"	\$970
	WA2466 FX	24"x66" Surface - FX W 66" D 24" H 1.25"	\$1077
	WA2472 FX	24"x72" Surface - FX W 72" D 24" H 1.25"	\$1077
	WA2484 FX	24"x84" Surface - FX W 84" D 24" H 1.25"	\$1392
	WA2496.2 FX	24"x96" Surface, 2-Piece - FX W 96" D 24" H 1.25"	\$2922
	WA3624 FX	24"x36" Cross-Grain Surface - FX W 36" D 24" H 1.25"	\$803

IMAGE	CODE	DESCRIPTION	LIST
	WA4224 FX	24"x42" Cross-Grain Surface - FX W 42" D 24" H 1.25"	\$843
	WA4824 FX	24"x48" Cross-Grain Surface - FX W 48" D 24" H 1.25"	\$869
	WA5424 FX	24"x54" Cross-Grain Surface - FX W 24" D 54" H 1.25"	\$970
	WA6024 FX	24"x60" Cross-Grain Surface - FX W 60" D 24" H 1.25"	\$970
30" Deep Rectangular	WA3036 FX	30"x36" Surface - FX W 36" D 30" H 1.25"	\$869
	WA3042 FX	30"x42" Surface - FX W 42" D 30" H 1.25"	\$1082

# SURFACES FX PROGRAM

IMAGE	CODE	DESCRIPTION	LIST
	WA3048 FX	30"x48" Surface - FX W 48" D 30" H 1.25"	\$1082
	WA3054 FX	30"x54" Surface - FX W 54" D 30" H 1.25"	\$1091
	WA3060 FX	30"x60" Surface - FX W 60" D 30" H 1.25"	\$1091
	WA3066 FX	30"x66" Surface - FX W 66" D 30" H 1.25"	\$1145
	WA3072 FX	30"x72" Surface - FX W 72" D 30" H 1.25"	\$1145
	WA3084 FX	30"x84" Surface - FX W 84" D 30" H 1.25"	\$1392
	WA3096.2 FX	30"x96" Surface, 2-Piece - FX W 96" D 30" H 1.25"	\$2922

IMAGE	CODE	DESCRIPTION	LIST
	WA3630 FX	30"x36" Cross-Grain Surface - FX W 36" D 30" H 1.25"	\$869
	WA4830 FX	30"x48" Cross-Grain Surface - FX W 48" D 30" H 1.25"	\$1082
	WA5430 FX	30"x54" Cross-Grain Surface - FX W 54" D 30" H 1.25"	\$1091
	WA6030 FX	30"x60" Cross-Grain Surface - FX W 60" D 30" H 1.25"	\$1091
36" Deep Rectangular	WA3648 FX	36"x48" Surface - FX W 48" D 36" H 1.25"	\$1145
	WA3654 FX	36"x54" Surface - FX W 54" D 36" H 1.25"	\$1145

# SURFACES FX PROGRAM

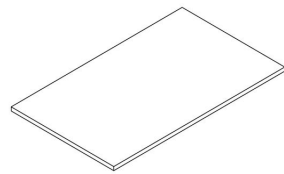
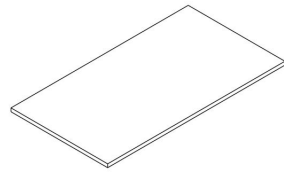
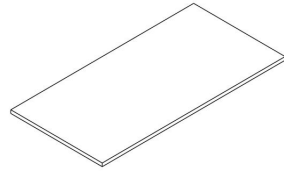
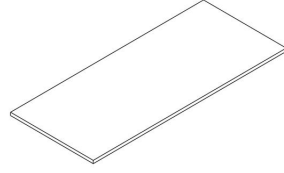
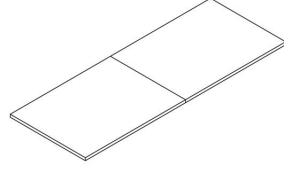
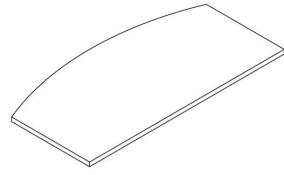
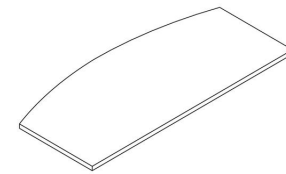
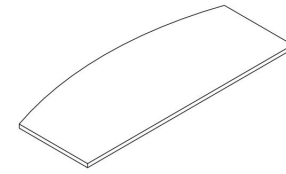
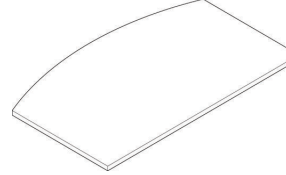
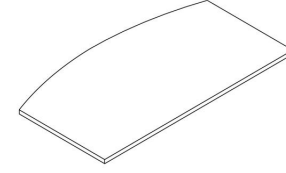
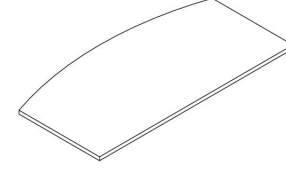
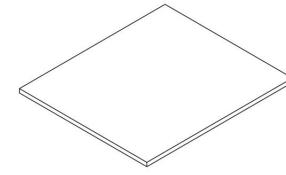
IMAGE	CODE	DESCRIPTION	LIST
	WA3660 FX	36"x60" Surface - FX W 60" D 36" H 1.25"	\$1145
	WA3666 FX	36"x66" Surface - FX W 66" D 36" H 1.25"	\$1145
	WA3672 FX	36"x72" Surface - FX W 72" D 36" H 1.25"	\$1392
	WA3684 FX	36"x84" Surface - FX W 84" D 36" H 1.25"	\$1602
	WA3696.2 FX	36"x96" Surface, 2-Piece - FX W 96" D 36" H 1.25"	\$2922
Bow-Front 	WA3060BOW FX	30"x60" Bow-Front Surface - FX W 60" D 30" H 1.25"	\$1392

IMAGE	CODE	DESCRIPTION	LIST
	WA3066BOW FX	30"x66" Bow-Front Surface - FX W 66" D 30" H 1.25"	\$1392
	WA3072BOW FX	30"x72" Bow-Front Surface - FX W 72" D 30" H 1.25"	\$1392
	WA3660BOW FX	36"x60" Bow-Front Surface - FX W 60" D 36" H 1.25"	\$1392
	WA3666BOW FX	36"x66" Bow-Front Surface - FX W 66" D 36" H 1.25"	\$1392
	WA3672BOW FX	36"x72" Bow-Front Surface - FX W 72" D 36" H 1.25"	\$1392
Conference 42" Deep 	WA4248 FX	42"x48" Surface - FX W 48" D 42" H 1.25"	\$1425

# SURFACES FX PROGRAM

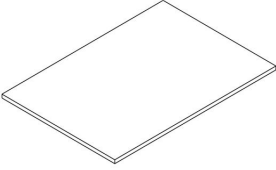
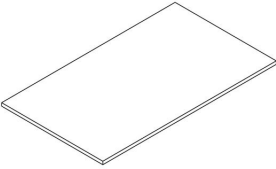
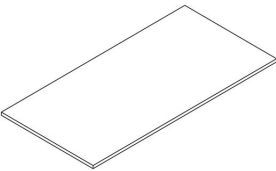
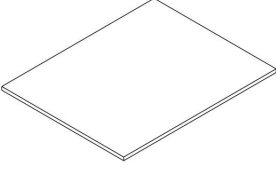
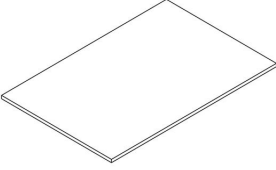
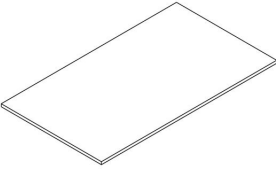
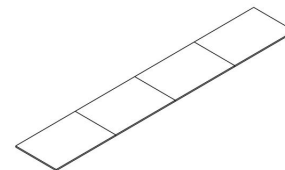
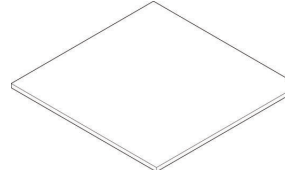
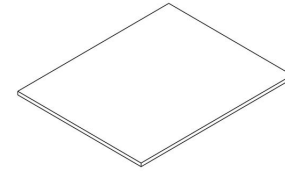
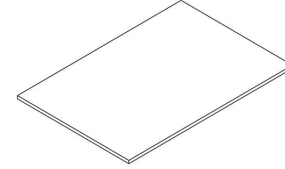
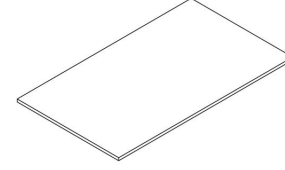
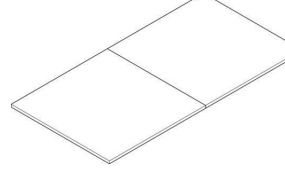
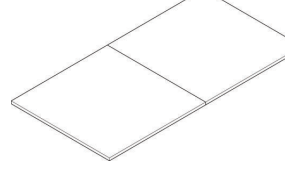
IMAGE	CODE	DESCRIPTION	LIST
	WA4260 FX	42"x60" Surface - FX W 60" D 42" H 1.25"	\$1425
	WA4272 FX	42"x72" Surface - FX W 72" D 42" H 1.25"	\$1425
	WA4284 FX	42"x84" Surface - FX W 84" D 42" H 1.25"	\$1602
Conference 48" Deep 	WA4860 FX	48"x60" Conference Table Surface - FX W 60" D 48" H 1.25"	\$1425
	WA4872 FX	48"x72" Conference Table Surface - FX W 72" D 48" H 1.25"	\$1425
	WA4884 FX	48"x84" Conference Table Surface - FX W 84" D 48" H 1.25"	\$1602

IMAGE	CODE	DESCRIPTION	LIST
Conference 49" Deep 	WA49108.CONF FX	49"x108" Conference Table Surface, 2-Piece - FX W 108" D 49" H 1.25"	\$2922
	WA49120.CONF FX	49"x120" Conference Table Surface, 2-Piece - FX W 120" D 49" H 1.25"	\$2922
	WA49132.CONF FX	49"x132" Conference Table Surface, 2-Piece - FX W 132" D 49" H 1.25"	\$3033
	WA49144.CONF FX	49"x144" Conference Table Surface, 2-Piece - FX W 144" D 49" H 1.25"	\$3033
	WA49156.CONF FX	49"x156" Conference Table Surface, 2-Piece - FX W 156" D 49" H 1.25"	\$3143
	WA49168.CONF FX	49"x168" Conference Table Surface, 2-Piece - FX W 168" D 49" H 1.25"	\$3143

# SURFACES FX PROGRAM

IMAGE	CODE	DESCRIPTION	LIST
	WA49180.CONF.3 FX	49"x180" Conference Table Surface, 3-Piece - FX W 180" D 49" H 1.25"	\$5786
	WA49192.CONF.3 FX	49"x192" Conference Table Surface, 3-Piece - FX W 192" D 49" H 1.25"	\$5786
	WA49204.CONF.3 FX	49"x204" Conference Table Surface, 3-Piece - FX W 204" D 49" H 1.25"	\$5786
	WA49216.CONF.3 FX	49"x216" Conference Table Surface, 3-Piece - FX W 216" D 49" H 1.25"	\$5786
	WA49228.CONF.3 FX	49"x228" Conference Table Surface, 3-Piece - FX W 228" D 49" H 1.25"	\$5786
	WA49240.CONF.3 FX	49"x240" Conference Table Surface, 3-Piece - FX W 240" D 49" H 1.25"	\$5786
	WA49264.CONF.4 FX	49"x264" Conference Table Surface, 4-Piece - FX W 264" D 49" H 1.25"	\$9659

IMAGE	CODE	DESCRIPTION	LIST
	WA49288.CONF.4 FX	49"x288" Conference Table Surface, 4-Piece - FX W 288" D 49" H 1.25"	\$9798
	WA4948 FX	49"x48" Surface - FX W 48" D 49" H 1.25"	\$1425
	WA4960 FX	49"x60" Conference Table Surface - FX W 60" D 49" H 1.25"	\$1425
	WA4972 FX	49"x72" Conference Table Surface - FX W 72" D 49" H 1.25"	\$1425
	WA4984 FX	49"x84" Conference Table Surface - FX W 84" D 49" H 1.25"	\$1602
	WA4996.CONF FX	49"x96" Conference Table Surface, 2-Piece - FX W 96" D 49" H 1.25"	\$2922
	WA4996.CONF.MB WAMB	49"x96" Conference Table Marker-Board Surface, 2-Piece - FX W 96" D 49" H 1.25"	\$3152

# SURFACES FX PROGRAM

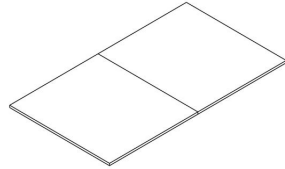
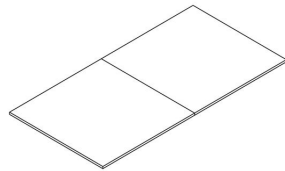
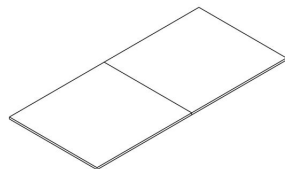
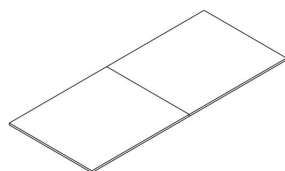
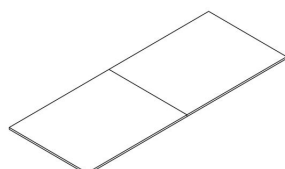
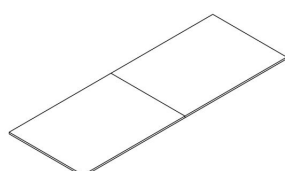
IMAGE	CODE	DESCRIPTION	LIST
Conference 61" Deep 	WA61108.CONF FX	61"x108" Conference Table Surface, 2-Piece - FX W 108" D 61" H 1.25"	\$2922
	WA61120.CONF FX	61"x120" Conference Table Surface, 2-Piece - FX W 120" D 61" H 1.25"	\$2922
	WA61132.CONF FX	61"x132" Conference Table Surface, 2-Piece - FX W 132" D 61" H 1.25"	\$3033
	WA61144.CONF FX	61"x144" Conference Table Surface, 2-Piece - FX W 144" D 61" H 1.25"	\$3033
	WA61156.CONF FX	61"x156" Conference Table Surface, 2-Piece - FX W 156" D 61" H 1.25"	\$3143
	WA61168.CONF FX	61"x168" Conference Table Surface, 2-Piece - FX W 168" D 61" H 1.25"	\$3143

IMAGE	CODE	DESCRIPTION	LIST
	WA61180.CONF.3 FX	61"x180" Conference Table Surface, 3-Piece - FX W 180" D 61" H 1.25"	\$6493
	WA61192.CONF.3 FX	61"x192" Conference Table Surface, 3-Piece - FX W 192" D 61" H 1.25"	\$6493
	WA61204.CONF.3 FX	61"x204" Conference Table Surface, 3-Piece - FX W 204" D 61" H 1.25"	\$6606
	WA61216.CONF.3 FX	61"x216" Conference Table Surface, 3-Piece - FX W 216" D 61" H 1.25"	\$6606
	WA61228.CONF.3 FX	61"x228" Conference Table Surface, 3-Piece - FX W 228" D 61" H 1.25"	\$6716
	WA61240.CONF.3 FX	61"x240" Conference Table Surface, 3-Piece - FX W 240" D 61" H 1.25"	\$6716
	WA61264.CONF.4 FX	61"x264" Conference Table Surface, 4-Piece - FX W 264" D 61" H 1.25"	\$11878

# SURFACES FX PROGRAM

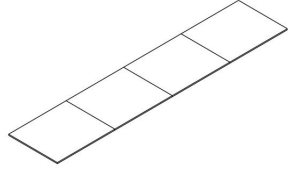
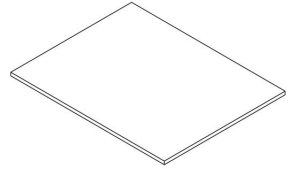
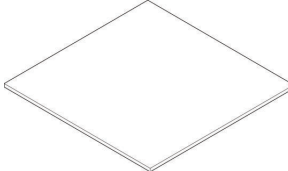
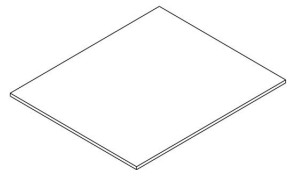
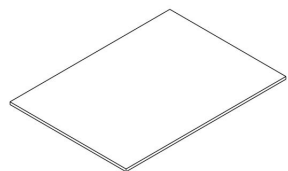
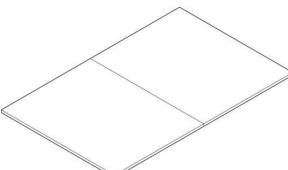
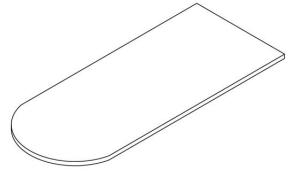
IMAGE	CODE	DESCRIPTION	LIST
	WA61288.CONF.4 FX	61"x288" Conference Table Surface, 4-Piece - FX W 288" D 61" H 1.25"	\$12102
	WA6148 FX	61"x48" Surface - FX W 48" D 61" H 1.25"	\$1913
	WA6160 FX	61"x60" Surface - FX W 60" D 61" H 1.25"	\$1913
	WA6172 FX	61"x72" Conference Table Surface - FX W 72" D 61" H 1.25"	\$2086
	WA6184 FX	61"x84" Conference Table Surface - FX W 84" D 61" H 1.25"	\$2086
	WA6196.CONF FX	61"x96" Conference Table Surface, 2-Piece - FX W 96" D 61" H 1.25"	\$2922
	WA7230D.L FX	72"x30" D-End Surface (D-End on Left) - FX W 72" D 30" H 1.25"	\$1392

IMAGE	CODE	DESCRIPTION	LIST
	WA7230D.R FX	72"x30" D-End Surface (D-End on Right) - FX W 72" D 30" H 1.25"	\$1392
	WA7236D.L FX	72"x36" D-End Surface (D-End on Left) - FX W 72" D 36" H 1.25"	\$1392
	WA7236D.R FX	72"x36" D-End Surface (D-End on Right) - FX W 72" D 36" H 1.25"	\$1392
	WA8430D.L FX	84"x30" D-End Surface (D-End on Left) - FX W 84" D 30" H 1.25"	\$1392
	WA8430D.R FX	84"x30" D-End Surface (D-End on Right) - FX W 84" D 30" H 1.25"	\$1392
	WA8436D.L FX	84"x36" D-End Surface (D-End on Left) - FX W 84" D 36" H 1.25"	\$1392
	WA8436D.R FX	84"x36" D-End Surface (D-End on Right) - FX W 84" D 36" H 1.25"	\$1392

# SURFACES FX PROGRAM

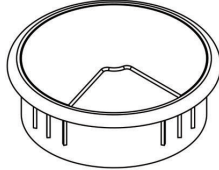
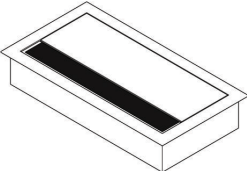
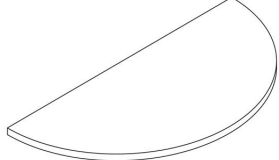
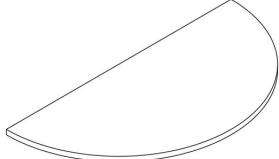
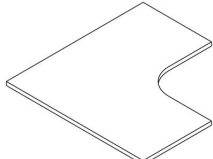
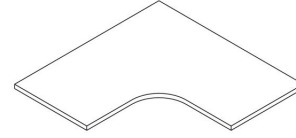
IMAGE	CODE	DESCRIPTION	LIST
Grommets 	BLW80 BLK, SLV, WHT	Grommet [80mm, For FX Surfaces] W 3.15" D 3.15" H 0.75"	\$30
	CNWG SLV	Wire Management Grommet [For Conference Surfaces, Cutout Size 4"x8"] W 8.31" D 4.42" H 0.13"	\$99
Half-Round 	WAHR.A FX	24.813"x49.625" Half-Round Surface - FX W 49.625" D 24.813" H 1.25"	\$1091
	WAHR.B FX	30.813"x61.625" Half-Round Surface - FX W 61.625" D 30.813" H 1.25"	\$1091
L-Shape 24" Deep 	WA4824L4824.L FX	48"x48" L-Shape Surface (24" Deep, Return on Left) - FX W 48" D 48" H 1.25"	\$1392
	WA4824L4824.R FX	48"x48" L-Shape Surface (24" Deep, Return on Right) - FX W 48" D 48" H 1.25"	\$1392

IMAGE	CODE	DESCRIPTION	LIST
	WA4824L6024.L FX	48"x60" L-Shape Surface (24" Deep, Return on Left) - FX W 48" D 60" H 1.25"	\$1392
	WA4824L6024.R FX	48"x60" L-Shape Surface (24" Deep, Return on Right) - FX W 48" D 60" H 1.25"	\$1392
	WA4824L7224.L FX	48"x72" L-Shape Surface (24" Deep, Return on Left) - FX W 48" D 72" H 1.25"	\$1392
	WA4824L7224.R FX	48"x72" L-Shape Surface (24" Deep, Return on Right) - FX W 48" D 72" H 1.25"	\$1392
	WA6024L4824.L FX	60"x48" L-Shape Surface (24" Deep, Return on Left) - FX W 60" D 48" H 1.25"	\$1392
	WA6024L4824.R FX	60"x48" L-Shape Surface (24" Deep, Return on Right) - FX W 60" D 48" H 1.25"	\$1392
	WA6024L6024.L FX	60"x60" L-Shape Surface (24" Deep, Return on Left) - FX W 60" D 60" H 1.25"	\$1392

# SURFACES FX PROGRAM

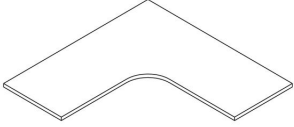
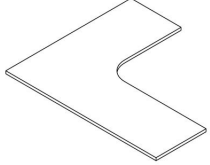
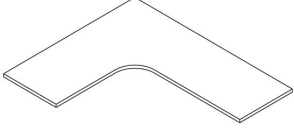
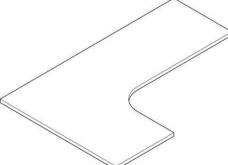
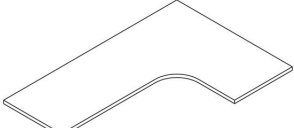
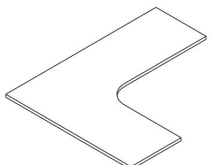
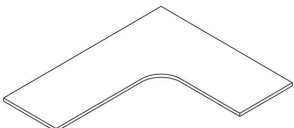
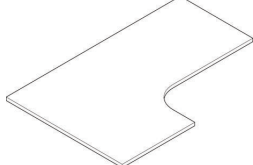
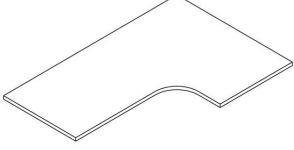
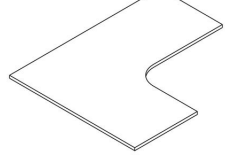
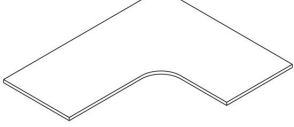
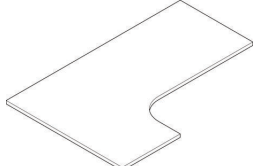
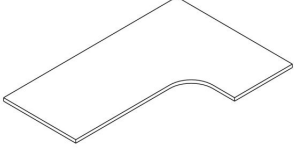
IMAGE	CODE	DESCRIPTION	LIST
	WA6024L6024.R FX	60"x60" L-Shape Surface (24" Deep, Return on Right) - FX W 60" D 60" H 1.25"	\$1392
	WA6024L7224.L FX	60"x72" L-Shape Surface (24" Deep, Return on Left) - FX W 60" D 72" H 1.25"	\$1913
	WA6024L7224.R FX	60"x72" L-Shape Surface (24" Deep, Return on Right) - FX W 60" D 72" H 1.25"	\$1913
	WA7224L4824.L FX	72"x48" L-Shape Surface (24" Deep, Return on Left) - FX W 72" D 48" H 1.25"	\$1392
	WA7224L4824.R FX	72"x48" L-Shape Surface (24" Deep, Return on Right) - FX W 72" D 48" H 1.25"	\$1392
	WA7224L6024.L FX	72"x60" L-Shape Surface (24" Deep, Return on Left) - FX W 72" D 60" H 1.25"	\$1913
	WA7224L6024.R FX	72"x60" L-Shape Surface (24" Deep, Return on Right) - FX W 72" D 60" H 1.25"	\$1913

IMAGE	CODE	DESCRIPTION	LIST
L-Shape 30" Deep 	WA7230L4830.L FX	72"x48" L-Shape Surface (30" Deep, Return on Left) - FX W 72" D 48" H 1.25"	\$1392
	WA7230L4830.R FX	72"x48" L-Shape Surface (30" Deep, Return on Right) - FX W 72" D 48" H 1.25"	\$1392
	WA7230L6030.L FX	72"x60" L-Shape Surface (30" Deep, Return on Left) - FX W 72" D 60" H 1.25"	\$1913
	WA7230L6030.R FX	72"x60" L-Shape Surface (30" Deep, Return on Right) - FX W 72" D 60" H 1.25"	\$1913
L-Shape 30"/24" Deep 	WA7230L4824.L FX	72"x48" L-Shape Surface (30"/24" Deep, Return on Left) - FX W 72" D 48" H 1.25"	\$1392
	WA7230L4824.R FX	72"x48" L-Shape Surface (30"/24" Deep, Return on Right) - FX W 72" D 48" H 1.25"	\$1392

# SURFACES FX PROGRAM

IMAGE	CODE	DESCRIPTION	LIST
	WA7230L6024.L FX	72"x60" L-Shape Surface (30"/24" Deep, Return on Left) - FX W 72" D 60" H 1.25"	\$1913
	WA7230L6024.R FX	72"x60" L-Shape Surface (30"/24" Deep, Return on Right) - FX W 72" D 60" H 1.25"	\$1913
P-Shape	WA7236P.L FX	72"x36" P-Shape Surface (P-Shape on Left) - FX W 72" D 36" H 1.25"	\$1392
	WA7236P.R FX	72"x36" P-Shape Surface (P-Shape on Right) - FX W 72" D 36" H 1.25"	\$1392
	WA8436P.L FX	84"x36" P-Shape Surface (P-Shape on Left) - FX W 84" D 36" H 1.25"	\$1392
	WA8436P.R FX	84"x36" P-Shape Surface (P-Shape on Right) - FX W 84" D 36" H 1.25"	\$1392

IMAGE	CODE	DESCRIPTION	LIST
Round 	WA30R FX	30" Round Surface - FX W 30" D 30" H 1.25"	\$843
	WA36R FX	36" Round Surface - FX W 36" D 36" H 1.25"	\$1008
	WA42R FX	42" Round Surface - FX W 42" D 42" H 1.25"	\$1119
	WA48R FX	48" Round Surface - FX W 48" D 48" H 1.25"	\$1119
	WA60R FX	60" Round Surface - FX W 60" D 60" H 1.25"	\$1152
Square 	WA3636 FX	36"x36" Surface - FX W 36" D 36" H 1.25"	\$1056

# SURFACES FX PROGRAM

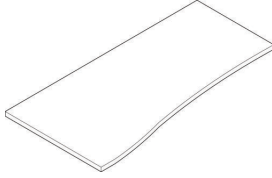
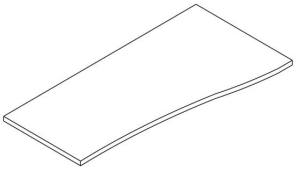
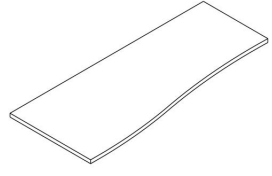
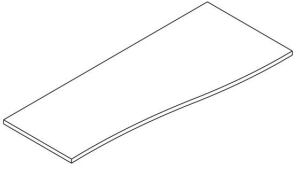
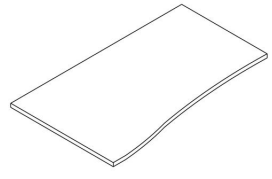
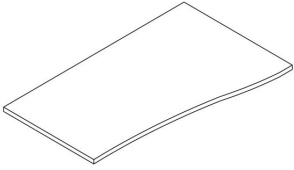
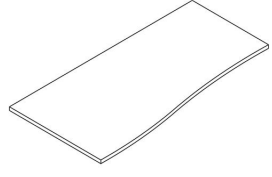
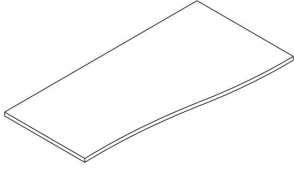
IMAGE	CODE	DESCRIPTION	LIST
Wave 24"-30" Deep 	WA24.3060WAVE.L FX	24"-30"x60" Wave Surface (30" Deep on Left) - FX W 60" D 24"-30" H 1.25"	\$1392
	WA24.3060WAVE.R FX	24"-30"x60" Wave Surface (30" Deep on Right) - FX W 60" D 24"-30" H 1.25"	\$1392
	WA24.3072WAVE.L FX	24"-30"x72" Wave Surface (30" Deep on Left) - FX W 72" D 24"-30" H 1.25"	\$1392
	WA24.3072WAVE.R FX	24"-30"x72" Wave Surface (30" Deep on Right) - FX W 72" D 24"-30" H 1.25"	\$1392
Wave 30"-36" Deep 	WA30.3660WAVE.L FX	30"-36"x60" Wave Surface (36" Deep on Left) - FX W 60" D 30"-36" H 1.25"	\$1392
	WA30.3660WAVE.R FX	30"-36"x60" Wave Surface (36" Deep on Right) - FX W 60" D 30"-36" H 1.25"	\$1392

IMAGE	CODE	DESCRIPTION	LIST
	WA30.3672WAVE.L FX	30"-36"x72" Wave Surface (36" Deep on Left) - FX W 72" D 30"-36" H 1.25"	\$1392
	WA30.3672WAVE.R FX	30"-36"x72" Wave Surface (36" Deep on Right) - FX W 72" D 30"-36" H 1.25"	\$1392

# TABLES BASES + LAPTOP TABLE

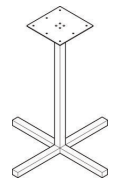
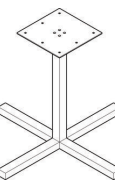
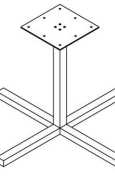
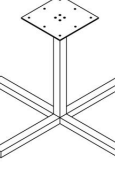

IMAGE	CODE	DESCRIPTION	LIST
Standing-Height X-Bases 	<b>XTBH32</b> <b>BLK, SLV, WHT</b>	32" Standing-Height X-Base [38.39" High, For 36"-41" Surfaces] - FAST <b>W 32" D 32" H 38.39"</b>	\$629
X-Bases 	<b>XT32</b> <b>BLK, SLV, WHT</b>	32" X-Base [27.36" High, For 36"-41" Surfaces] - FAST <b>W 32" D 32" H 27.36"</b>	\$547
	<b>XT36</b> <b>BLK, SLV, WHT</b>	36" X-Base [27.36" High, For 42"-45" Surfaces] - FAST <b>W 36" D 36" H 27.36"</b>	\$598
	<b>XT38</b> <b>BLK, SLV, WHT</b>	38" X-Base [27.36" High, For 46"-50" Surfaces] - FAST <b>W 38" D 38" H 27.75"</b>	\$600

IMAGE	CODE	DESCRIPTION	LIST
	<b>LPT</b> <b>BLK, SLV, WHT</b>	Laptop Table Base [26.5" High] <b>W 22.25" D 13" H 26.5"</b>	\$396
	<b>LPT.TOP</b> <b>ELM, OAK, WHT, MPL</b>	Laptop Table Surface [1" Thick] - FAST <b>W 24.75" D 16" H 1"</b>	\$207

# TABLES LEGS + LOUNGE TABLES

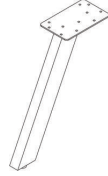



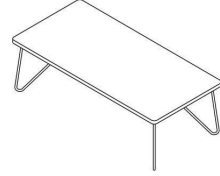
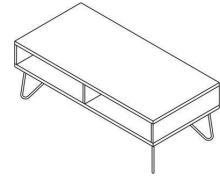
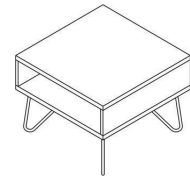

IMAGE	CODE	DESCRIPTION	LIST
Legs 	APL BLK, SLV, WHT	Angled Post Leg [27.5" High] W 7.87" D 12.6" H 27.36"	\$165
	PLMK BLK, SLV, WHT	Post Leg Mobile Kit, Set of 4 [Includes Locking Casters] W 4.5" D 4.5" H 27.5"	\$553
	PLSK BLK, SLV, WHT	Post Leg Stationary Kit, Set of 4 W 4.5" D 4.5" H 27.5"	\$539
Standing-Height Legs 	APLSH BLK, SLV, WHT	Angled Standing-Height Post Leg [38.25" High] W 7.87" D 16.81" H 38.39"	\$234

IMAGE	CODE	DESCRIPTION	LIST
Coffee Tables 	KOT BLK, WAL	24"x50" Veneer Coffee Table [15.85" High, Includes 4 Matte Black Legs] W 24" D 50" H 15.85"	\$1579
	KOTD2 BLK, WAL	24"x50" Veneer Cubby Coffee Table [18" High, Includes 4 Matte Black Legs] W 24" D 50" H 18"	\$3147
Side Tables 	KOTD1 BLK, WAL	24"x24" Veneer Cubby Side Table [18" High, Includes 4 Matte Black Legs] W 24" D 24" H 18"	\$1504
	KOTS BLK, WAL	15"x15" Veneer Side Table [22.5" High, Includes 4 Matte Black Legs] W 15" D 15" H 22.5"	\$537

# PANELS BRACKETS + END PANELS

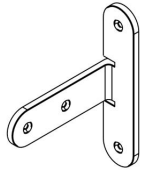
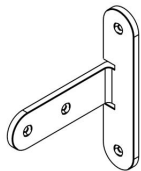

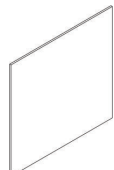
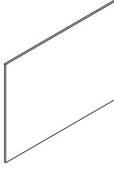
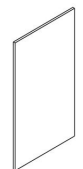
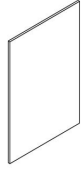
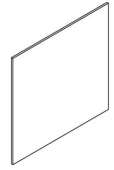
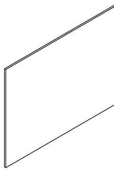
IMAGE	CODE	DESCRIPTION	LIST
End Panel Brackets 	LEPBL1 BLK, SLV, WHT	End Panel T-Bracket [Includes Laminate-to-Metal Hardware] W 2.75" D 0.62" H 2.375"	\$40
	LLTB BLK, SLV, WHT	Laminated-to-Laminated T-Bracket [Includes Laminated-to-Laminated Hardware] W 2.75" D 0.62" H 2.375"	\$40
Modesty Panel Brackets 	BMPBFB BLK, SLV, WHT	3.5"x13.75" Modesty Panel L-Bracket [Includes Hardware] W 3.56" D 0.81" H 13.75"	\$20
	KIT-AMPB4 BLK, SLV, WHT	Modesty Panel L-Bracket, Set of 2 [For Acrylic Modesty Panels] W 0.81" D 3.56" H 13.75"	\$78

IMAGE	CODE	DESCRIPTION	LIST
Laminated Divider-Height 	GBEPSS50 ELM, MPL, OAK, SAH, WHT	50" Laminated Divider-Height End Panel [48" High, 0.75" Thick] - FAST W 50" D 0.75" H 48"	\$742
	GBEPSS62 ELM, MPL, OAK, SAH, WHT	62" Laminated Divider-Height End Panel [48" High, 0.75" Thick] - FAST W 62" D 0.75" H 48"	\$783
Laminated Divider-Height (FX) 	WABEPDH.A FX	26" Laminated Divider-Height End Panel [48" High, 0.75" Thick] - FX W 26" D 0.75" H 48"	\$1894
	WABEPDH.B FX	32" Laminated Divider-Height End Panel [48" High, 0.75" Thick] - FX W 32" D 0.75" H 48"	\$1894
	WABEPDH.C FX	50" Laminated Divider-Height End Panel [48" High, 0.75" Thick] - FX W 50" D 0.75" H 48"	\$1894
	WABEPDH.D FX	62" Laminated Divider-Height End Panel [48" High, 0.75" Thick] - FX W 62" D 0.75" H 48"	\$1894

# PANELS END PANELS + MODESTY PANELS

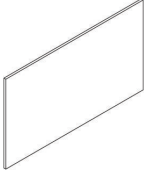
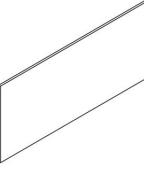
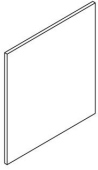
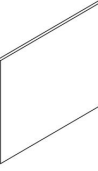
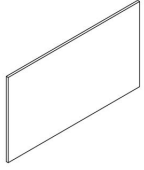
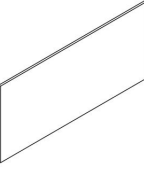
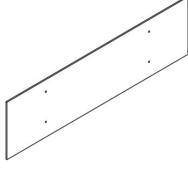
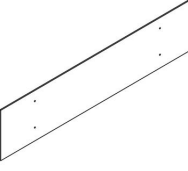
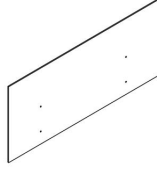
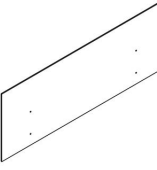
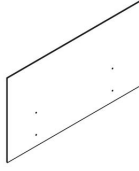
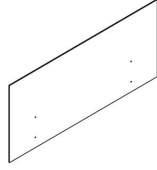
IMAGE	CODE	DESCRIPTION	LIST
Laminate Surface-Height 	GBEPLH50 ELM, MPL, OAK, SAH, WHT	50" Laminate Surface-Height End Panel [28" High, 0.75" Thick] - FAST W 50" D 0.75" H 28"	\$660
	GBEPLH62 ELM, MPL, OAK, SAH, WHT	62" Laminate Surface-Height End Panel [28" High, 0.75" Thick] - FAST W 62" D 0.75" H 28"	\$679
Laminate Surface-Height (FX) 	WABEPSH.A FX	26" Laminate Surface-Height End Panel [28" High, 0.75" Thick] - FX W 26" D 0.75" H 28"	\$1602
	WABEPSH.B FX	32" Laminate Surface-Height End Panel [28" High, 0.75" Thick] - FX W 32" D 0.75" H 28"	\$1602
	WABEPSH.C FX	50" Laminate Surface-Height End Panel [28" High, 0.75" Thick] - FX W 50" D 0.75" H 28"	\$1602
	WABEPSH.D FX	62" Laminate Surface-Height End Panel [28" High, 0.75" Thick] - FX W 62" D 0.75" H 28"	\$1602

IMAGE	CODE	DESCRIPTION	LIST
Acrylic (FX) 	AMP55.FX CLR, FRS	55" Acrylic Modesty Panel [15" High, Beveled Edges, For 60" Surfaces] - Frosted Acrylic W 55" D 0.25"-0.63" H 15"	\$1696
	AMP67.FX CLR, FRS	67" Acrylic Modesty Panel [15" High, Beveled Edges, For 72" Surfaces] - Frosted Acrylic W 67" D 0.25"-0.63" H 15"	\$1770
Acrylic High/Low (FX) 	ADMP2455.FX CLR, FRS	55" Acrylic Divider/Modesty Panel [24" High, 16.5" Below/6" Above, Beveled Edge, For 60" Surfaces] - Frosted Acrylic W 55" D 0.25"-0.63" H 24"	\$2199
	ADMP2467.FX CLR, FRS	67" Acrylic Divider/Modesty Panel [24" High, 16.5" Below/6" Above, Beveled Edge, For 72" Surfaces] - Frosted Acrylic W 67" D 0.25"-0.63" H 24"	\$2230
	ADMP3055.FX CLR, FRS	55" Acrylic Divider/Modesty Panel [30" High, 16.5" Below/12" Above, Beveled Edge, For 60" Surfaces] - Frosted Acrylic W 55" D 0.25"-0.63" H 30"	\$4187
	ADMP3067.FX CLR, FRS	67" Acrylic Divider/Modesty Panel [30" High, 16.5" Below/12" Above, Beveled Edge, For 72" Surfaces] - Frosted Acrylic W 67" D 0.25"-0.63" H 30"	\$4187

# PANELS MODESTY PANELS

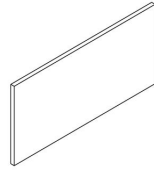
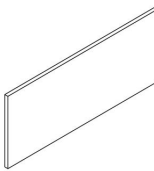
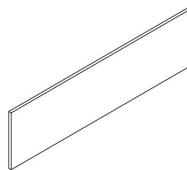
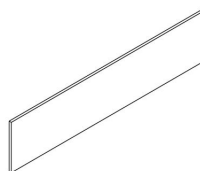
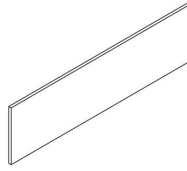
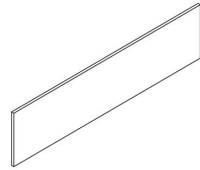
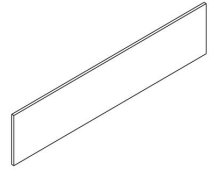
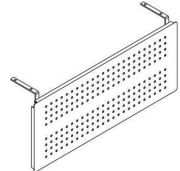
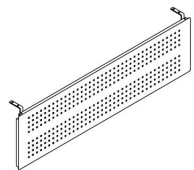
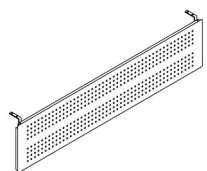
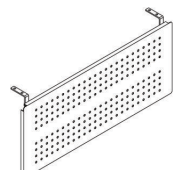
IMAGE	CODE	DESCRIPTION	LIST
Laminate 	GLMP31 ELM, MPL, OAK, SAH, WHT	31" Laminate Modesty Panel [15" High, 0.75" Thick, For 36" Surfaces] - FAST W 31" D 0.75" H 15"	\$184
	GLMP37V2 ELM, MPL, OAK, SAH, WHT	37" Laminate Modesty Panel (V2) [15" High, 0.75" Thick, For 42" & 48" Surfaces] - FAST W 37" D 0.75" H 15"	\$191
	GLMP55V2 ELM, MPL, OAK, SAH, WHT	55" Laminate Modesty Panel (V2) [15" High, 0.75" Thick, For 60" Surfaces] - FAST W 55" D 0.75" H 15"	\$253
	GLMP66V2 ELM, MPL, OAK, SAH, WHT	66" Laminate Modesty Panel (V2) [15" High, 0.75" Thick, For 72" Surfaces] - FAST W 66" D 0.75" H 15"	\$297
Laminate (FX) 	WA.BMP55 FX	55" Laminate Modesty Panel [15" High, 0.75" Thick, For 60" Surfaces] - FX W 55" D 0.75" H 15"	\$1894
	WA.BMP61 FX	61" Laminate Modesty Panel [15" High, 0.75" Thick, For 66" Surfaces] - FX W 61" D 0.75" H 15"	\$1894

IMAGE	CODE	DESCRIPTION	LIST
	WA.BMP67 FX	67" Laminate Modesty Panel [15" High, 0.75" Thick, For 72" Surfaces] - FX W 67" D 0.75" H 15"	\$1894
Steel 	BMP36 BLK, SLV, WHT	BLADE 36" Steel Modesty Panel [15" High, Includes Brackets, For 48" Surfaces] W 36" D 0.62" H 15"	\$285
	BMP55V2 BLK, SLV, WHT	55" Steel Modesty Panel (V2) [15" High, Includes Brackets, For 60" & 66" Surfaces] W 55" D 0.62" H 15"	\$300
	BMP67V2 BLK, SLV, WHT	67" Steel Modesty Panel (V2) [15" High, Includes Brackets, For 72" Surfaces] W 67" D 0.62" H 15"	\$339
	KIT-BHAMP36 BLK, SLV, WHT	BOOST 36" Steel Modesty Panel [15" High, Includes Brackets, For 48" Surfaces] W 36" D 0.62" H 15"	\$324

# DIVIDERS ACRYLIC (CLEAR)

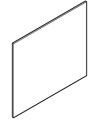
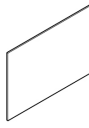




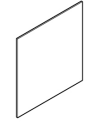
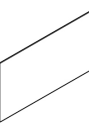



IMAGE	CODE	DESCRIPTION	LIST
<p>20" High (FX)</p>  <p>ADD 2 BSB9 BRACKETS</p>	AC2023.CLR	<p>23" Acrylic Divider [20" High, Square Corners, Beveled Edges] - Clear Acrylic</p> <p>W 23" D 0.25"-0.63" H 20"</p>	\$307
 <p>ADD 2 BSB9 BRACKETS</p>	AC2029.CLR	<p>29" Acrylic Divider [20" High, Square Corners, Beveled Edges] - Clear Acrylic</p> <p>W 29" D 0.25"-0.63" H 20"</p>	\$413
 <p>ADD 3 BSB9 BRACKETS</p>	AC2047.CLR	<p>47" Acrylic Divider [20" High, Square Corners, Beveled Edges] - Clear Acrylic</p> <p>W 47" D 0.25"-0.63" H 20"</p>	\$551
 <p>ADD 3 BSB9 BRACKETS</p>	AC2059.CLR	<p>59" Acrylic Divider [20" High, Square Corners, Beveled Edges] - Clear Acrylic</p> <p>W 59" D 0.25"-0.63" H 20"</p>	\$1173
 <p>ADD 3 BSB9 BRACKETS</p>	AC2065.CLR	<p>65" Acrylic Divider [20" High, Square Corners, Beveled Edges] - Clear Acrylic</p> <p>W 65" D 0.25"-0.63" H 20"</p>	\$1217
 <p>ADD 3 BSB9 BRACKETS</p>	AC2071.CLR	<p>71" Acrylic Divider [20" High, Square Corners, Beveled Edges] - Clear Acrylic</p> <p>W 71" D 0.25"-0.63" H 20"</p>	\$1259

IMAGE	CODE	DESCRIPTION	LIST
<p>24" High (FX)</p>  <p>ADD 2 BSB9 BRACKETS</p>	AC2423.CLR	<p>23" Acrylic Divider [24" High, Square Corners, Beveled Edges] - Clear Acrylic</p> <p>W 23" D 0.25"-0.63" H 24"</p>	\$307
 <p>ADD 2 BSB9 BRACKETS</p>	AC2429.CLR	<p>29" Acrylic Divider [24" High, Square Corners, Beveled Edges] - Clear Acrylic</p> <p>W 29" D 0.25"-0.63" H 24"</p>	\$413
 <p>ADD 3 BSB9 BRACKETS</p>	AC2447.CLR	<p>47" Acrylic Divider [24" High, Square Corners, Beveled Edges] - Clear Acrylic</p> <p>W 47" D 0.25"-0.63" H 24"</p>	\$572
 <p>ADD 3 BSB9 BRACKETS</p>	AC2459.CLR	<p>59" Acrylic Divider [24" High, Square Corners, Beveled Edges] - Clear Acrylic</p> <p>W 59" D 0.25"-0.63" H 24"</p>	\$1195
 <p>ADD 3 BSB9 BRACKETS</p>	AC2465.CLR	<p>65" Acrylic Divider [24" High, Square Corners, Beveled Edges] - Clear Acrylic</p> <p>W 65" D 0.25"-0.63" H 24"</p>	\$1248
 <p>ADD 3 BSB9 BRACKETS</p>	AC2471.CLR	<p>71" Acrylic Divider [24" High, Square Corners, Beveled Edges] - Clear Acrylic</p> <p>W 71" D 0.25"-0.63" H 24"</p>	\$1248

# DIVIDERS ACRYLIC (FROSTED)

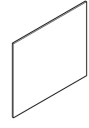
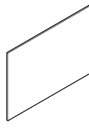




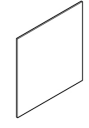
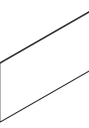



IMAGE	CODE	DESCRIPTION	LIST
20" High (FX)  ADD 2 BSB9 BRACKETS	AC2023.FRS	23" Acrylic Divider [20" High, Square Corners, Beveled Edges] - Frosted Acrylic W 23" D 0.25"-0.63" H 20"	\$557
 ADD 2 BSB9 BRACKETS	AC2029.FRS	29" Acrylic Divider [20" High, Square Corners, Beveled Edges] - Frosted Acrylic W 29" D 0.25"-0.63" H 20"	\$724
 ADD 3 BSB9 BRACKETS	AC2047.FRS	47" Acrylic Divider [20" High, Square Corners, Beveled Edges] - Frosted Acrylic W 47" D 0.25"-0.63" H 20"	\$1060
 ADD 3 BSB9 BRACKETS	AC2059.FRS	59" Acrylic Divider [20" High, Square Corners, Beveled Edges] - Frosted Acrylic W 59" D 0.25"-0.63" H 20"	\$2121
 ADD 3 BSB9 BRACKETS	AC2065.FRS	65" Acrylic Divider [20" High, Square Corners, Beveled Edges] - Frosted Acrylic W 65" D 0.25"-0.63" H 20"	\$2121
 ADD 3 BSB9 BRACKETS	AC2071.FRS	71" Acrylic Divider [20" High, Square Corners, Beveled Edges] - Frosted Acrylic W 71" D 0.25"-0.63" H 20"	\$2121

IMAGE	CODE	DESCRIPTION	LIST
24" High (FX)  ADD 2 BSB9 BRACKETS	AC2423.FRS	23" Acrylic Divider [24" High, Square Corners, Beveled Edges] - Frosted Acrylic W 23" D 0.25"-0.63" H 24"	\$557
 ADD 2 BSB9 BRACKETS	AC2429.FRS	29" Acrylic Divider [24" High, Square Corners, Beveled Edges] - Frosted Acrylic W 29" D 0.25"-0.63" H 24"	\$724
 ADD 3 BSB9 BRACKETS	AC2447.FRS	47" Acrylic Divider [24" High, Square Corners, Beveled Edges] - Frosted Acrylic W 47" D 0.25"-0.63" H 24"	\$1060
 ADD 3 BSB9 BRACKETS	AC2459.FRS	59" Acrylic Divider [24" High, Square Corners, Beveled Edges] - Frosted Acrylic W 59" D 0.25"-0.63" H 24"	\$2121
 ADD 3 BSB9 BRACKETS	AC2465.FRS	65" Acrylic Divider [24" High, Square Corners, Beveled Edges] - Frosted Acrylic W 65" D 0.25"-0.63" H 24"	\$2121
 ADD 3 BSB9 BRACKETS	AC2471.FRS	71" Acrylic Divider [24" High, Square Corners, Beveled Edges] - Frosted Acrylic W 71" D 0.25"-0.63" H 24"	\$2121

# DIVIDERS BRACKETS

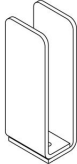
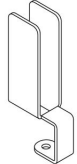
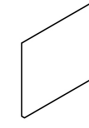
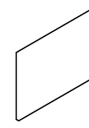
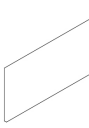
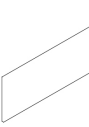
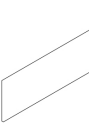

IMAGE	CODE	DESCRIPTION	LIST
	BRONS BLK, SLV	Screw-In PET Divider Bracket W 1.5" D 1.11" H 4"	\$90
	BSB9 BLK, SLV, WHT	Divider Bracket (Version 9) [Includes Shims] W 1.5" D 2.38" H 3"	\$54
	BSBACR CHRM	Screw-In Divider Bracket [Includes Shims] W 2.19" D 1.25" H 2.19"	\$86
	BSBHL BLK, SLV, WHT	High/Low Divider Brackets, Set of 2 W 3.63" D 3.38" H 5.88"	\$208
	BSBV10 BLK, SLV, WHT	Divider Bracket (Version 10) W 1.5" D 2.75" H 5"	\$54
	BSLM9 BLK, SLV, WHT	Slim Divider Bracket (Version 9) [Includes Shims] W 0.75" D 2.375" H 3"	\$54
	BSLMV10 BLK, SLV, WHT	Slim Divider Bracket (Version 10) W 0.75" D 2.75" H 4.875"	\$54

IMAGE	CODE	DESCRIPTION	LIST
	GBRB1 BLK, SLV	Clamp-On PET Divider Bracket W 2.3" D 1.11" H 5.65"	\$90
	TWMH CHRM	Tackboard Wall-Mounting Hardware	\$26

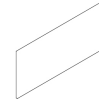
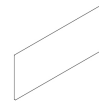
# DIVIDERS FABRIC

IMAGE	CODE	DESCRIPTION	LIST
<p>20" High</p>  <p>ADD 2 BSBV10 BRACKETS</p>	GBD2023 BLU, GRY	23" Tackable Fabric Divider [20" High] - FAST W 23" D 1" H 20"	\$282
 <p>ADD 2 BSBV10 BRACKETS</p>	GBD2029 BLU, GRY	29" Tackable Fabric Divider [20" High] - FAST W 29" D 1" H 20"	\$321
 <p>ADD 3 BSBV10 BRACKETS</p>	GBD2047 BLU, GRY	47" Tackable Fabric Divider [20" High] - FAST W 47" D 1" H 20"	\$422
 <p>ADD 3 BSBV10 BRACKETS</p>	GBD2059 BLU, GRY	59" Tackable Fabric Divider [20" High] - FAST W 59" D 1" H 20"	\$604
 <p>ADD 3 BSBV10 BRACKETS</p>	GBD2065 BLU, GRY	65" Tackable Fabric Divider [20" High] - FAST W 65" D 1" H 20"	\$629
 <p>ADD 3 BSBV10 BRACKETS</p>	GBD2071 BLU, GRY	71" Tackable Fabric Divider [20" High] - FAST W 71" D 1" H 20"	\$661

IMAGE	CODE	DESCRIPTION	LIST
<p>20" High (FX)</p>  <p>ADD 2 BSBV10 BRACKETS</p>	GFS2023.FXCOM FX-Mayer or COM	23" Tackable Fabric Divider [20" High, Requires 0.9 Yards] - FX/COM W 23" D 0.88" H 20"	\$467
 <p>ADD 2 BSBV10 BRACKETS</p>	GFS2029.FXCOM FX-Mayer or COM	29" Tackable Fabric Divider [20" High, Requires 1.0 Yards] - FX/COM W 29" D 0.88" H 20"	\$504
 <p>ADD 3 BSBV10 BRACKETS</p>	GFS2047.FXCOM FX-Mayer or COM	47" Tackable Fabric Divider [20" High, Requires 1.5 Yards] - FX/COM W 47" D 0.88" H 20"	\$632
 <p>ADD 3 BSBV10 BRACKETS</p>	GFS2059.FXCOM FX-Mayer or COM	59" Tackable Fabric Divider [20" High, Requires 1.9 Yards] - FX/COM W 59" D 0.88" H 20"	\$861
 <p>ADD 3 BSBV10 BRACKETS</p>	GFS2065.FXCOM FX-Mayer or COM	65" Tackable Fabric Divider [20" High, Requires 2.0 Yards] - FX/COM W 65" D 0.88" H 20"	\$944
 <p>ADD 3 BSBV10 BRACKETS</p>	GFS2071.FXCOM FX-Mayer or COM	71" Tackable Fabric Divider [20" High, Requires 2.3 Yards] - FX/COM W 71" D 0.88" H 20"	\$1025

# DIVIDERS FABRIC

IMAGE	CODE	DESCRIPTION	LIST
30" High  <small>IF SURFACE MOUNTING: ADD 4 BSBV10 BRACKETS</small>	GBD3047 <b>BLU, GRY</b>	47" Tackable Fabric Divider [30" High] - FAST <b>W 47" D 1" H 30"</b>	\$688
 <small>IF SURFACE MOUNTING: ADD 4 BSBV10 BRACKETS</small>	GBD3059 <b>BLU, GRY</b>	59" Tackable Fabric Divider [30" High] - FAST <b>W 59" D 1" H 30"</b>	\$924
 <small>IF SURFACE MOUNTING: ADD 4 BSBV10 BRACKETS</small>	GBD3065 <b>BLU, GRY</b>	65" Tackable Fabric Divider [30" High] - FAST <b>W 65" D 1" H 30"</b>	\$1128
 <small>IF SURFACE MOUNTING: ADD 4 BSBV10 BRACKETS</small>	GBD3071 <b>BLU, GRY</b>	71" Tackable Fabric Divider [30" High] - FAST <b>W 71" D 1" H 30"</b>	\$1185
30" High (FX)  <small>IF SURFACE MOUNTING: ADD 4 BSBV10 BRACKETS</small>	GFS3047.FXCOM <b>FX-Mayer or COM</b>	47" Tackable Fabric Divider [30" High, Requires 3.0 Yards] - FX/COM <b>W 47" D 0.88" H 30"</b>	\$982
 <small>IF SURFACE MOUNTING: ADD 4 BSBV10 BRACKETS</small>	GFS3059.FXCOM <b>FX-Mayer or COM</b>	59" Tackable Fabric Divider [30" High, Requires 3.8 Yards] - FX/COM <b>W 59" D 0.88" H 30"</b>	\$1319

IMAGE	CODE	DESCRIPTION	LIST
 <small>IF SURFACE MOUNTING: ADD 4 BSBV10 BRACKETS</small>	GFS3065.FXCOM <b>FX-Mayer or COM</b>	65" Tackable Fabric Divider [30" High, Requires 4.0 Yards] - FX/COM <b>W 65" D 0.88" H 30"</b>	\$1611
 <small>IF SURFACE MOUNTING: ADD 4 BSBV10 BRACKETS</small>	GFS3071.FXCOM <b>FX-Mayer or COM</b>	71" Tackable Fabric Divider [30" High, Requires 4.5 Yards] - FX/COM <b>W 71" D 0.88" H 30"</b>	\$1693

# DIVIDERS GLASS

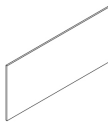
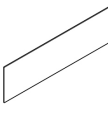

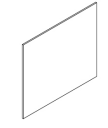
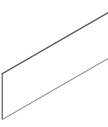

IMAGE	CODE	DESCRIPTION	LIST
13" High  ADD 2 BSB9 BRACKETS	B12GS23 Dry Erase Frosted Glass	23" Dry-Erase Frosted Glass Divider [13" High] W 23" D 0.31" H 13"	\$317
 ADD 2 BSB9 BRACKETS	B12GS29 Dry Erase Frosted Glass	29" Dry-Erase Frosted Glass Divider [13" High] W 29" D 0.31" H 13"	\$360
 ADD 3 BSB9 BRACKETS	B12GS47 Dry Erase Frosted Glass	47" Dry-Erase Frosted Glass Divider [13" High] W 47" D 0.31" H 13"	\$530
 ADD 3 BSB9 BRACKETS	B12GS58 Dry Erase Frosted Glass	58" Dry-Erase Frosted Glass Divider [13" High] W 58" D 0.31" H 13"	\$626
 ADD 3 BSB9 BRACKETS	B12GS70 Dry Erase Frosted Glass	71" Dry-Erase Frosted Glass Divider [13" High] W 71" D 0.31" H 13"	\$748
20" High  ADD 2 BSB9 BRACKETS	BMBGS23 Dry Erase Frosted Glass	23" Dry-Erase Frosted Glass Divider [20" High] W 23" D 0.31" H 20"	\$385

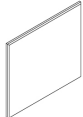
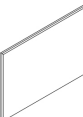
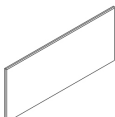
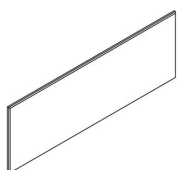
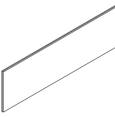
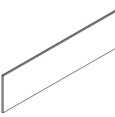
IMAGE	CODE	DESCRIPTION	LIST
 ADD 2 BSB9 BRACKETS	BMBGS29 Dry Erase Frosted Glass	29" Dry-Erase Frosted Glass Divider [20" High] W 29" D 0.31" H 20"	\$444
 ADD 3 BSB9 BRACKETS	BMBGS47 Dry Erase Frosted Glass	47" Dry-Erase Frosted Glass Divider [20" High] W 47" D 0.31" H 20"	\$665
 ADD 3 BSB9 BRACKETS	BMBGS59 Dry Erase Frosted Glass	59" Dry-Erase Frosted Glass Divider [20" High] W 59" D 0.31" H 20"	\$791
 ADD 3 BSB9 BRACKETS	BMBGS71 Dry Erase Frosted Glass	71" Dry-Erase Frosted Glass Divider [20" High] W 71" D 0.31" H 20"	\$953
30" High  IF SURFACE MOUNTING: ADD 2 BSBV10 BRACKETS + 2 RSB10 SHIMS	BMBGS3023 Dry Erase Frosted Glass	23" Dry-Erase Frosted Glass Divider [30" High] W 23" D 0.31" H 30"	\$464
 IF SURFACE MOUNTING: ADD 2 BSBV10 BRACKETS + 2 RSB10 SHIMS	BMBGS3029 Dry Erase Frosted Glass	29" Dry-Erase Frosted Glass Divider [30" High] W 29" D 0.31" H 30"	\$549

# DIVIDERS GLASS + HEIGHT-ADJUSTABLE

IMAGE	CODE	DESCRIPTION	LIST
 <p>IF SURFACE MOUNTING: ADD 4 BSBV10 BRACKETS + 4 RSB10 SHIMS</p>	BMBGS3047 <b>Dry Erase Frosted Glass</b>	47" Dry-Erase Frosted Glass Divider [30" High] W 47" D 0.31" H 30"	\$842
 <p>IF SURFACE MOUNTING: ADD 4 BSBV10 BRACKETS + 4 RSB10 SHIMS</p>	BMBGS3058 <b>Dry Erase Frosted Glass</b>	58" Dry-Erase Frosted Glass Divider [30" High] W 58" D 0.31" H 30"	\$1006
 <p>IF SURFACE MOUNTING: ADD 4 BSBV10 BRACKETS + 4 RSB10 SHIMS</p>	BMBGS3071 <b>Dry Erase Frosted Glass</b>	71" Dry-Erase Frosted Glass Divider [30" High] W 71" D 0.31" H 30"	\$1214

IMAGE	CODE	DESCRIPTION	LIST
Glass Panel 	B12GS33 <b>Dry Erase Frosted Glass</b>	33" Dry Erase Frosted Glass Divider [13" High] W 33" D .313" H 12"	\$360
	B12GS59 <b>Dry Erase Frosted Glass</b>	59" Dry Erase Frosted Glass Divider [13" High] W 59" D .313" H 12"	\$626
	B12GS74 <b>Dry Erase Frosted Glass</b>	74" Dry Erase Frosted Glass Divider [13" High] W 74" D .313" H 12"	\$748

# DIVIDERS PET

IMAGE	CODE	DESCRIPTION	LIST
<p>20" High</p>  <p>ADD 2 BSBV10 BRACKETS</p>	<p>AFD2023 BLK, BLU, GRY, WHT</p>	<p>23" Acoustic Divider [20" High, Beveled Edges] - FAST W 23" D 0.88" H 20"</p>	<p>\$116</p>
 <p>ADD 2 BSBV10 BRACKETS</p>	<p>AFD2029 BLK, BLU, GRY, WHT</p>	<p>29" Acoustic Divider [20" High, Beveled Edges] - FAST W 29" D 0.88" H 20"</p>	<p>\$145</p>
 <p>ADD 3 BSBV10 BRACKETS</p>	<p>AFD2047 BLK, BLU, GRY, WHT</p>	<p>47" Acoustic Divider [20" High, Beveled Edges] - FAST W 47" D 0.88" H 20"</p>	<p>\$231</p>
	<p>AFD2059 BLK, BLU, GRY, WHT</p>	<p>59" Acoustic Divider [20" High, Beveled Edges] - FAST W 59" D 0.88" H 20"</p>	<p>\$288</p>
 <p>ADD 3 BSBV10 BRACKETS</p>	<p>AFD2065 BLK, BLU, GRY, WHT</p>	<p>65" Acoustic Divider [20" High, Beveled Edges] - FAST W 65" D 0.88" H 20"</p>	<p>\$317</p>
 <p>ADD 3 BSBV10 BRACKETS</p>	<p>AFD2071 BLK, BLU, GRY, WHT</p>	<p>71" Acoustic Divider [20" High, Beveled Edges] - FAST W 71" D 0.88" H 20"</p>	<p>\$346</p>

# TONOS BRACKETS + PET SCREENS

IMAGE	CODE	DESCRIPTION	LIST
	PCOMB BLK, SLV, WHT	PET 18mm - Clamp-On Modesty Bracket W 1.77 D 2.12 H 4.19	\$45
	PCOOSB BLK, SLV, WHT	PET 18mm - Clamp-On On-Surface Bracket W 1.77 D 2.12 H 7.54	\$65
	PSIEMB BLK, SLV, WHT	PET 18mm - Screw-In Edge-Mount Bracket W 1.97 D 3.07 H 4.72	\$38
	PSIOSB BLK, SLV, WHT	PET 18mm - Screw-In On-Surface Bracket W 1.77 D 1.02 H 3.35	\$40

IMAGE	CODE	DESCRIPTION	LIST
Half Desk	PET182421-HD	Half Desk PET Panel [18H x 24W x 21R] W 23.5 D 21.0 H 18.0	\$1
	PET182427-HD	Half Desk PET Panel [18H x 24W x 27R] W 23.5 D 27.0 H 18.0	\$1
	PET183021-HD	Half Desk PET Panel [18H x 30W x 21R] W 29.5 D 21.0 H 18.0	\$1
	PET183027-HD	Half Desk PET Panel [18H x 30W x 27R] W 29.5 D 27.0 H 18.0	\$1
	PET183321-HD	Half Desk PET Panel [18H x 33W x 21R] W 32.5 D 21.0 H 18.0	\$1
	PET183327-HD	Half Desk PET Panel [18H x 33W x 27R] W 32.5 D 27.0 H 18.0	\$1
	PET183621-HD	Half Desk PET Panel [18H x 36W x 21R] W 35.5 D 21.0 H 18.0	\$1
	PET183627-HD	Half Desk PET Panel [18H x 36W x 27R] W 35.5 D 27.0 H 18.0	\$1
	PET232421-HD	Half Desk PET Panel [23H x 24W x 21R] W 23.5 D 21.0 H 23.0	\$1
	PET232427-HD	Half Desk PET Panel [23H x 24W x 27R] W 23.5 D 27.0 H 23.0	\$1

# TONOS PET SCREENS

IMAGE	CODE	DESCRIPTION	LIST
	PET233021-HD	Half Desk PET Panel [23H x 30W x 21R] W 29.5 D 21.0 H 23.0	\$1
	PET233027-HD	Half Desk PET Panel [23H x 30W x 27R] W 29.5 D 27.0 H 23.0	\$1
	PET233321-HD	Half Desk PET Panel [23H x 33W x 21R] W 32.5 D 21.0 H 23.0	\$1
	PET233327-HD	Half Desk PET Panel [23H x 33W x 27R] W 32.5 D 27.0 H 23.0	\$1
	PET233621-HD	Half Desk PET Panel [23H x 36W x 21R] W 35.5 D 21.0 H 23.0	\$1
	PET233627-HD	Half Desk PET Panel [23H x 36W x 27R] W 35.5 D 27.0 H 23.0	\$1
	PET282421-HD	Half Desk PET Panel [28H x 24W x 21R] W 23.5 D 21.0 H 28.0	\$1
	PET282427-HD	Half Desk PET Panel [28H x 24W x 27R] W 23.5 D 27.0 H 28.0	\$1
	PET283021-HD	Half Desk PET Panel [28H x 30W x 21R] W 29.5 D 21.0 H 28.0	\$1
	PET283027-HD	Half Desk PET Panel [28H x 30W x 27R] W 29.5 D 27.0 H 28.0	\$1

IMAGE	CODE	DESCRIPTION	LIST
	PET283321-HD	Half Desk PET Panel [28H x 33W x 21R] W 32.5 D 21.0 H 28.0	\$1
	PET283327-HD	Half Desk PET Panel [28H x 33W x 27R] W 32.5 D 27.0 H 28.0	\$1
	PET283621-HD	Half Desk PET Panel [28H x 36W x 21R] W 35.5 D 21.0 H 28.0	\$1
	PET283627-HD	Half Desk PET Panel [28H x 36W x 27R] W 35.5 D 27.0 H 28.0	\$1
L-shape	PET184521-LS	L-shape PET Panel [18H x 45W x 21R] W 45.0 D 21.0 H 18.0	\$1
	PET184527-LS	L-shape PET Panel [18H x 45W x 27R] W 45.0 D 27.0 H 18.0	\$1
	PET185721-LS	L-shape PET Panel [18H x 57W x 21R] W 57.0 D 21.0 H 18.0	\$1
	PET185727-LS	L-shape PET Panel [18H x 57W x 27R] W 57.0 D 27.0 H 18.0	\$1
	PET186321-LS	L-shape PET Panel [18H x 63W x 21R] W 63.0 D 21.0 H 18.0	\$1
	PET186327-LS	L-shape PET Panel [18H x 63W x 27R] W 63.0 D 27.0 H 18.0	\$1

# TONOS PET SCREENS

IMAGE	CODE	DESCRIPTION	LIST
	PET186921-LS	L-shape PET Panel [18H x 69W x 21R] W 69.0 D 21.0 H 18.0	\$1
	PET234521-LS	L-shape PET Panel [23H x 45W x 21R] W 45.0 D 21.0 H 23.0	\$1
	PET234527-LS	L-shape PET Panel [23H x 45W x 27R] W 45.0 D 27.0 H 23.0	\$1
	PET235721-LS	L-shape PET Panel [23H x 57W x 21R] W 57.0 D 21.0 H 23.0	\$1
	PET235727-LS	L-shape PET Panel [23H x 57W x 27R] W 57.0 D 27.0 H 23.0	\$1
	PET236321-LS	L-shape PET Panel [23H x 63W x 21R] W 63.0 D 21.0 H 23.0	\$1
	PET236327-LS	L-shape PET Panel [23H x 63W x 27R] W 63.0 D 27.0 H 23.0	\$1
	PET236921-LS	L-shape PET Panel [23H x 69W x 21R] W 69.0 D 21.0 H 23.0	\$1
	PET284521-LS	L-shape PET Panel [28H x 45W x 21R] W 45.0 D 21.0 H 28.0	\$1
	PET284527-LS	L-shape PET Panel [28H x 45W x 27R] W 45.0 D 27.0 H 28.0	\$1

IMAGE	CODE	DESCRIPTION	LIST
	PET285721-LS	L-shape PET Panel [28H x 57W x 21R] W 57.0 D 21.0 H 28.0	\$1
	PET285727-LS	L-shape PET Panel [28H x 57W x 27R] W 57.0 D 27.0 H 28.0	\$1
	PET286321-LS	L-shape PET Panel [28H x 63W x 21R] W 63.0 D 21.0 H 28.0	\$1
	PET286327-LS	L-shape PET Panel [28H x 63W x 27R] W 63.0 D 27.0 H 28.0	\$1
	PET286921-LS	L-shape PET Panel [28H x 69W x 21R] W 69.0 D 21.0 H 28.0	\$1
Linear	PET1821-LIN	Linear PET Panel [18H x 21W] W 21.0 D 1.0 H 18.0	\$1
	PET1827-LIN	Linear PET Panel [18H x 27W] W 27.0 D 1.0 H 18.0	\$1
	PET1845-LIN	Linear PET Panel [18H x 45W] W 45.0 D 1.0 H 18.0	\$1
	PET1857-LIN	Linear PET Panel [18H x 57W] W 57.0 D 1.0 H 18.0	\$1
	PET1863-LIN	Linear PET Panel [18H x 63W] W 63.0 D 1.0 H 18.0	\$1
	PET1869-LIN	Linear PET Panel [18H x 69W] W 69.0 D 1.0 H 18.0	\$1
	PET2321-LIN	Linear PET Panel [23H x 21W] W 21.0 D 1.0 H 23.0	\$1

# TONOS PET SCREENS

IMAGE	CODE	DESCRIPTION	LIST
	PET2327-LIN	Linear PET Panel [23H x 27W] W 27.0 D 1.0 H 23.0	\$1
	PET2345-LIN	Linear PET Panel [23H x 45W] W 45.0 D 1.0 H 23.0	\$1
	PET2357-LIN	Linear PET Panel [23H x 57W] W 57.0 D 1.0 H 23.0	\$1
	PET2363-LIN	Linear PET Panel [23H x 63W] W 63.0 D 1.0 H 23.0	\$1
	PET2369-LIN	Linear PET Panel [23H x 69W] W 69.0 D 1.0 H 23.0	\$1
	PET2821-LIN	Linear PET Panel [28H x 21W] W 21.0 D 1.0 H 28.0	\$1
	PET2827-LIN	Linear PET Panel [28H x 27W] W 27.0 D 1.0 H 28.0	\$1
	PET2845-LIN	Linear PET Panel [28H x 45W] W 45.0 D 1.0 H 28.0	\$1
	PET2857-LIN	Linear PET Panel [28H x 57W] W 57.0 D 1.0 H 28.0	\$1
	PET2863-LIN	Linear PET Panel [28H x 63W] W 63.0 D 1.0 H 28.0	\$1
	PET2869-LIN	Linear PET Panel [28H x 69W] W 69.0 D 1.0 H 28.0	\$1
U-shape	PET184723-US	U-shape PET Panel [18H x 47W x 23R] W 47.0 D 23.0 H 18.0	\$1
	PET185918-US	U-shape PET Panel [18H x 59W x 18R] W 59.0 D 18.0 H 18.0	\$1

IMAGE	CODE	DESCRIPTION	LIST
	PET186615-US	U-shape PET Panel [18H x 66W x 15R] W 66.0 D 15.0 H 18.0	\$1
	PET187112-US	U-shape PET Panel [18H x 71W x 12R] W 71.0 D 12.0 H 18.0	\$1
	PET234723-US	U-shape PET Panel [23H x 47W x 23R] W 47.0 D 23.0 H 23.0	\$1
	PET235918-US	U-shape PET Panel [23H x 59W x 18R] W 59.0 D 18.0 H 23.0	\$1
	PET236615-US	U-shape PET Panel [23H x 66W x 15R] W 66.0 D 15.0 H 23.0	\$1
	PET237112-US	U-shape PET Panel [23H x 71W x 12R] W 71.0 D 12.0 H 23.0	\$1
	PET284723-US	U-shape PET Panel [28H x 47W x 23R] W 47.0 D 23.0 H 28.0	\$1
	PET285918-US	U-shape PET Panel [28H x 59W x 18R] W 59.0 D 18.0 H 28.0	\$1
	PET286615-US	U-shape PET Panel [28H x 66W x 15R] W 66.0 D 15.0 H 28.0	\$1
	PET287112-US	U-shape PET Panel [28H x 71W x 12R] W 71.0 D 12.0 H 28.0	\$1


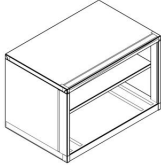
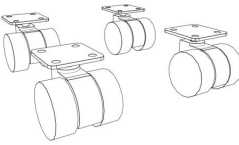
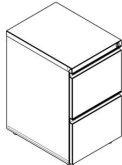
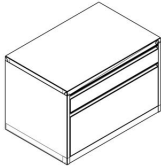
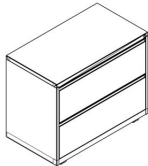
IMAGE	CODE	DESCRIPTION	LIST
	LCMS30 CBN, ALY, LUN, HRB, SHL, LIN, CYN, TER, FRN	Metal Storage Lateral cushion [Includes Foam, Magnet & Fabric Cover] W 30" D 20" H 1.5"	\$265
	MSBFP BLK, SLV, WHT	Metal Storage Box/File Pedestal [Includes Counterweight and Casters] W 15" D 20" H 20"	\$605
	MSBKC BLK, SLV, WHT	Metal Storage Bookcase W 30" D 20" H 20"	\$765
	MSCK4	Casters for Metal Storage (Set of 4)	\$60
	MSFFP25 BLK, SLV, WHT	Metal Storage File/File Pedestal [Includes Glides] W 15" D 20" H 25"	\$620
	MSLBF30 BLK, SLV, WHT	Metal Storage Lateral Box/File [Includes Glides] W 30" D 20" H 20"	\$985
	MSLFF36 BLK, SLV, WHT	Metal Storage Lateral Box/File [Includes Glides] W 30" D 20" H 27"	\$1160

IMAGE	CODE	DESCRIPTION	LIST
	PCMS15 CBN, ALY, LUN, HRB, SHL, LIN, CYN, TER, FRN	Metal Storage Pedestal cushion [Includes Foam, Magnet & Fabric Cover] W 15" D 20" H 1.5"	\$190

# STORAGE LAMINATE

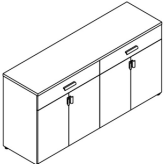

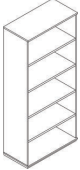
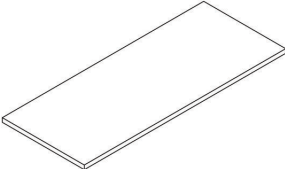
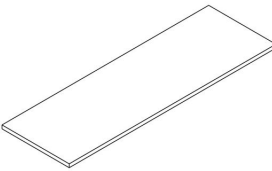
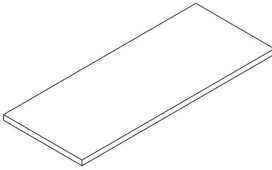
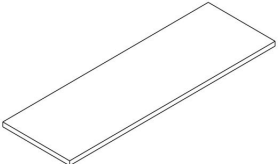
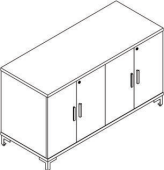
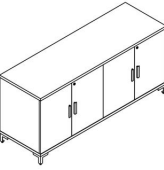
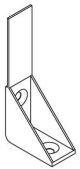
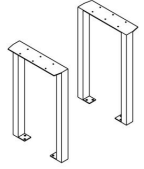
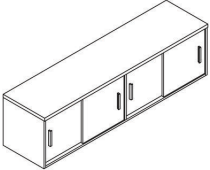
IMAGE	CODE	DESCRIPTION	LIST
	GBBC71 ELM, OAK, SAH, WHT	71" Laminate Buffet Credenza [36" High] - FAST W 71" D 20" H 36"	\$5216
Bookcases	BLBCD ELM, OAK, SAH, WHT	15.75" Laminate Bookcase Door Kit, Set of 2 [42" High] - FAST W 15.75" D 0.75" H 42"	\$348
			
	KIT-BLBC72 ELM, OAK, SAH, WHT	31.5" Laminate Bookcase [72" High] - FAST W 31.5" D 15.75" H 72"	\$1182
Credenza Tops	BLRT48 ELM	49"x20" Laminate Conference Credenza Top [1" Thick] - FAST W 49" D 20" H 1"	\$263
			
	BLRT60 ELM	61.5"x20" Laminate Conference Credenza Top [1" Thick] - FAST W 61.5" D 20" H 1"	\$348
Credenza Tops (FX)	WALAMCC.A FX	49"x20" Laminate Top [1.25" Thick, For 48" Laminate Conference Credenza] - FX W 49" D 20" H 1.25"	\$1164
			

IMAGE	CODE	DESCRIPTION	LIST
	WALAMCC.B FX	61.5"x20" Laminate Top [1.25" Thick, For 60" Laminate Conference Credenza] - FX W 61.5" D 20" H 1.25"	\$1374
Credenzas	BLCC48 ELM, OAK, SAH, WHT	48" Laminate Conference Credenza [28.5" High] - FAST W 49.13" D 20" H 28.35"	\$1389
			
	BLCC60 ELM, OAK, SAH, WHT	60" Laminate Conference Credenza [28.5" High] - FAST W 61.5" D 20" H 28.35"	\$1563
Hardware	KIT-LCCB WHT	Laminate Storage L-Bracket [For FAST/FX Laminate Top, Includes Laminate-to-Laminate Hardware]	\$0.01
			
Hutch Stands	KIT-BSHS24 BLK, SLV, WHT	Shared Hutch Stands, Set of 2 [24" High, Includes Hardware] W 15" D 3.88" H 24"	\$454
			
Hutches	BSDH60V3-K ELM, OAK, SAH, WHT	59" Laminate Sliding-Door Hutch (V3) [16" High, Includes Wall-Mounting Hardware] - FAST W 59" D 15" H 16"	\$799
			

# STORAGE LAMINATE

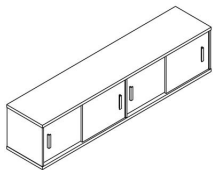
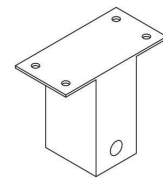

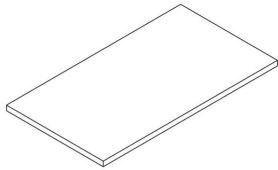
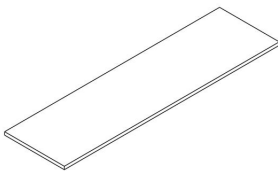
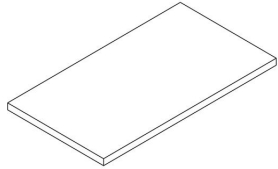
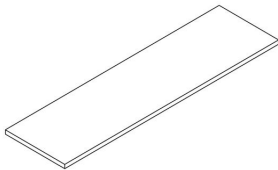

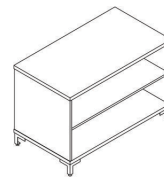
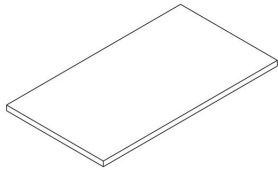
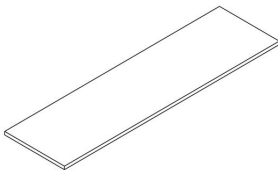
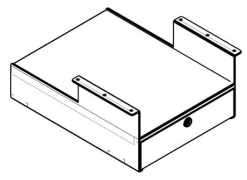
IMAGE	CODE	DESCRIPTION	LIST
	BSDH60V4 ELM, OAK, SAH, WHT	59" Laminate Sliding-Door Hutch (V4) [16" High, Includes Wall-Mounting Hardware] W 59" D 15" H 16"	\$799
	BSDH71V3-K ELM, OAK, SAH, WHT	71" Laminate Sliding-Door Hutch (V3) [16" High, Includes Wall-Mounting Hardware] - FAST W 71" D 15" H 16"	\$1062
Lateral Accessories	BLSS BLK, SLV, WHT	Surface Stand Kit, Set of 2 [3.5" High] W 1.97" D 3.94" H 3.35"	\$89
			
	LSF BLK, WHT	Laminate Storage Foot, Set of 4 W 3.62" D 3.62" H 3.82"	\$85
Lateral Tops	BLLRT ELM, OAK, SAH, WHT	36"x20" Laminate Top [1" Thick, For BLLBFV2 and BLLOSV2] - FAST W 36" D 20" H 1"	\$314
			
	GBLLT2 ELM, MPL, OAK, SAH, WHT	72"x20" Laminate Lateral-Merging Top [1" Thick] - FAST W 72" D 20" H 1"	\$366

IMAGE	CODE	DESCRIPTION	LIST
Lateral Tops (FX)	WALAMLF.A FX	36"x20" Laminate Top [1.25" Thick, For Single Laminate Lateral File] - FX W 36" D 20" H 1.25"	\$1099
			
	WALAMLF.B FX	72"x20" Laminate Top [1.25" Thick, For Merged Laminate Lateral Files] - FX W 72" D 20" H 1.25"	\$1374
Laterals	BLLBFV2 ELM, OAK, SAH, WHT	36" Laminate Low Box/File Lateral (V2) [24.5" High] - FAST W 36" D 20" H 24"	\$1217
			
	BLLOSV2 ELM, OAK, SAH, WHT	36" Laminate Low Open Shelf Lateral (V2) [24.5" High] - FAST W 36" D 20" H 24"	\$679

# STORAGE STEEL

IMAGE	CODE	DESCRIPTION	LIST
	DSTP11 BLK	Double-Sided Tape [1"x1"]	\$0.01
Lateral Tops 	GBSTL1 ELM, OAK, SAH, WHT	35.5"x19.75" Laminate Top [1" Thick, For Steel Lateral] - FAST W 35.5" D 19.75" H 1"	\$450
	GBSTL2 ELM, OAK, SAH, WHT	71"x19.75" Laminate Top [1" Thick, For Steel Lateral] - FAST W 71" D 19.75" H 1"	\$759
Storage Drawer 	BSMPS BLK, SLV, WHT	Steel Personal Storage Drawer [Locking, Surface-Mount] W 15.36" D 17.92" H 7.83"	\$396

# POWER 4-CIRCUIT

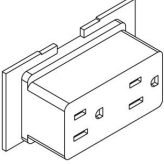
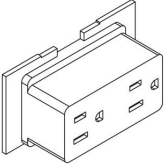
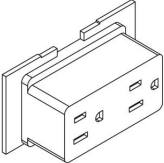
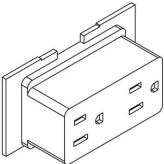
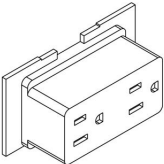
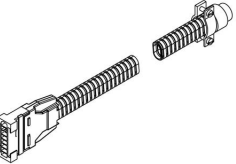


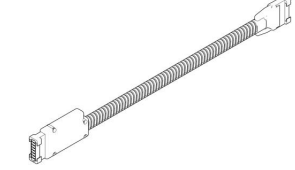
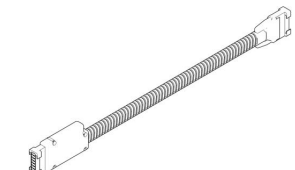
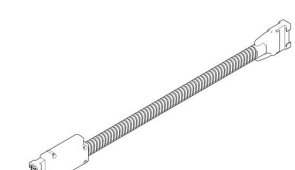
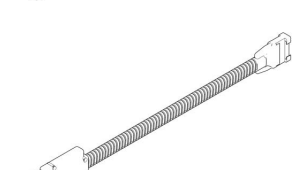
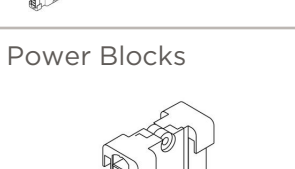
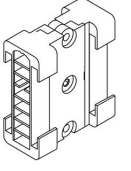
IMAGE	CODE	DESCRIPTION	LIST
Duplexes 	PROR1 BLK	4-Circuit Power Duplex Receptacle Circuit 1 W 3.44 D 1.25 H 1.81	\$52
	PROR2 BLK	4-Circuit Power Duplex Receptacle Circuit 2 W 3.44 D 1.25 H 1.81	\$52
	PROR223 BLK	4-Circuit Power Duplex Receptacle for 2+2 Circuit W 3.44 D 1.25 H 1.81	\$52
	PROR3 BLK	4-Circuit Power Duplex Receptacle Circuit 3 W 3.44 D 1.25 H 1.81	\$52
	PROR4 BLK	4-Circuit Power Duplex Receptacle Circuit 4 W 3.44 D 1.25 H 1.81	\$52
Infeed 	PROIF72 SLV	4-Circuit Power Infeed 72"	\$384

IMAGE	CODE	DESCRIPTION	LIST
	PROIFNYC SLV	4-Circuit Power New York Style Infeed, 120" W 164 D 0.81 H 2	\$533
Infeeds 	PROIF164 SLV	4-Circuit Power 164" In-feed W 164" D 0.81" H 2"	\$594
Jumpers 	PROJ24 SLV	4-Circuit Power 24" Jumper W 24" D 0.81" H 2"	\$191
	PROJ44 SLV	4-Circuit Power 44" Jumper W 44" D 0.81" H 2"	\$268
	PROJ49 SLV	4-Circuit Power 49" Jumper W 49" D 0.81" H 2"	\$277
	PROJ55 SLV	4-Circuit Power 55" Jumper W 55" D 0.81" H 2"	\$307
	PROJ61 SLV	4-Circuit Power 61" Jumper W 61" D 0.81" H 2"	\$326
Power Blocks 	PROBC BLK	4-Circuit Power In-Line Power Block Connector W 1.75" D 0.82" H 2.13"	\$46

# POWER 4-CIRCUIT + CONNECTOR BLOCKS

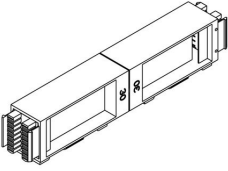
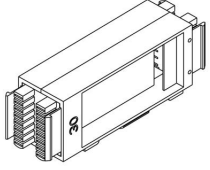
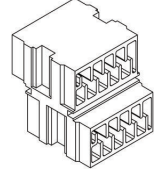
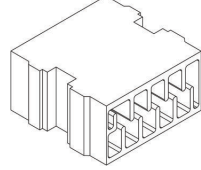
IMAGE	CODE	DESCRIPTION	LIST
	PRODB BLK	4-Circuit Power Double Power Block W 11.38 D 3.69 H 2.56	\$249
	PROSB BLK	4-Circuit Power Single Power Block W 5.31" D 3.69" H 2.56"	\$172

IMAGE	CODE	DESCRIPTION	LIST
	BPJCB BLK	4-Way Connector Block W 1.65" D 1.82" H 1.73"	\$27
	BPPCB BLK	2-Way Connector Block W 1.65" D 1.47" H 0.78"	\$27

# POWER DUPLEXES + HARNESSSES

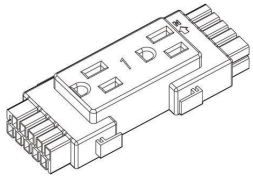
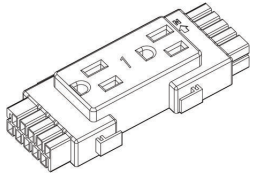
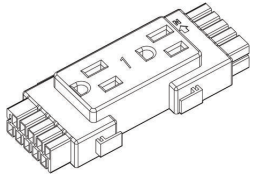
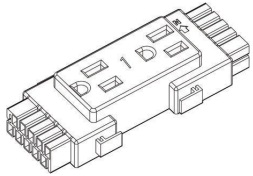
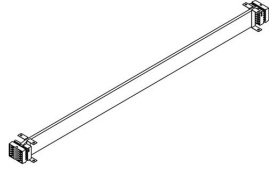
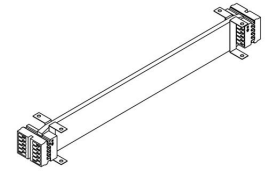
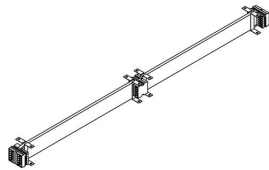
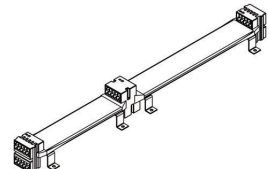
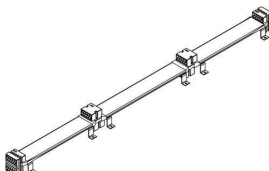
IMAGE	CODE	DESCRIPTION	LIST
	BPDR_C1 BLK	Duplex Receptacle (Configuration 1) [2 Outlets] W 4.65" D 0.1" H 1.95"	\$30
	BPDR_C2 BLK	Duplex Receptacle (Configuration 2) [2 Outlets] W 4.65" D 0.1" H 1.95"	\$30
	BPDR_C3 BLK	Duplex Receptacle (Configuration 3) [2 Outlets] W 4.65" D 0.1" H 1.95"	\$30
	BPDR_T24_C4 BLK	Duplex Receptacle (Configuration 4) [2 Outlets, Title 24 Compliant] W 4.65" D 0.1" H 1.95"	\$30

IMAGE	CODE	DESCRIPTION	LIST
BLADE Harnesses 	KIT-HARNESS SLV	BLADE 36" Harness [Requires 4 Duplex Receptacles, 8 Outlets] W 36.63" D 2.18" H 2.4"	\$447
	KIT-HARNESS-4 SLV	BLADE 18" Harness [Requires 4 Duplex Receptacles, 8 Outlets] W 18.63" D 2.18" H 2.4"	\$447
	KIT-HARNESS-8 SLV	BLADE 36" Harness [Requires 8 Duplex Receptacles, 16 Outlets, For 120 Degree Workstation] W 36.63" D 2.18" H 2.4"	\$447
BOOST Harnesses 	KIT-HARNESS-B24 SLV	BOOST 24" Harness [Requires 4 Duplex Receptacles, 8 Outlets, For 48" & 120 Degree Bridge Beams] W 25.63" D 3" H 2.17"	\$447
	KIT-HARNESS-B36 SLV	BOOST 36" Harness [Requires 6 Duplex Receptacles, 12 Outlets, For 60"-72" Bridge Beams] W 36.88" D 3" H 2.17"	\$447

# POWER INFEEDS + JUMPERS

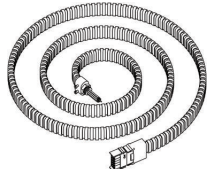
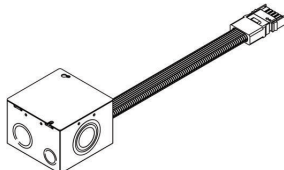
IMAGE	CODE	DESCRIPTION	LIST
 	BPIF164 SLV	164" In-Feed W 164" D 0.87" H 1.95"	\$626
	BPIF72 SLV	60" In-Feed W 60" D 0.87" H 1.95"	\$384
	KIT-NYC SLV	12" In-Feed Kit [NYC Electrical Code Compliant]	\$1003

IMAGE	CODE	DESCRIPTION	LIST
	BPJ12 SLV	12" Jumper W 12" D 0.87" H 1.95"	\$245
	BPJ144 SLV	144" Jumper W 144" D 0.87" H 1.95"	\$646
	BPJ15 SLV	15" Jumper W 15" D 0.87" H 1.95"	\$254
	BPJ18 SLV	18" Jumper W 18" D 0.87" H 1.95"	\$254
	BPJ29 SLV	29" Jumper W 29" D 0.87" H 1.95"	\$259
	BPJ42 SLV	42" Jumper W 42" D 0.87" H 1.95"	\$259
	BPJ72 SLV	72" Jumper W 72" D 0.87" H 1.95"	\$295

# POWER WIRE MANAGEMENT


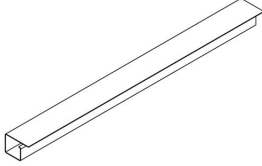
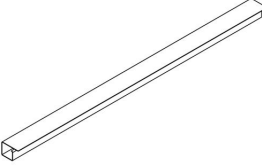
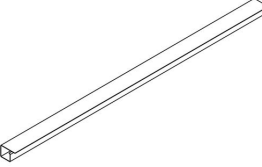
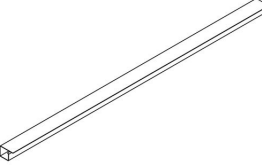
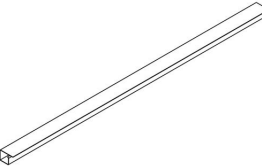
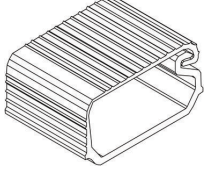

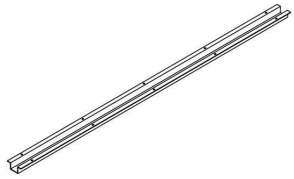
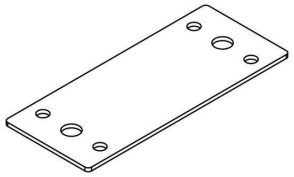
IMAGE	CODE	DESCRIPTION	LIST
Infeed Management 	KIT-PPOLE4 BLK, SLV, WHT	144" Power Pole, 2-Piece [Includes Bracket & Trim Plate] W 3.18" D 1.6" H 144"	\$412
Under-Surface Wire Management     	BMZ.24 BLK	24" Braided Mesh Zipper Wire Manager H 24"	\$129
	BMZ.48 BLK	48" Braided Mesh Zipper Wire Manager H 48"	\$158
	BWMJC.24 BLK	24" Cable J-Channel W 24" D 2" H 1"	\$93
	BWMJC.36 BLK	36" Cable J-Channel W 36" D 2" H 1"	\$93
	BWMJC.42 BLK	42" Cable J-Channel W 42" D 2" H 1"	\$93
	BWMJC.47 BLK	47" Cable J-Channel W 47" D 2" H 1"	\$93

IMAGE	CODE	DESCRIPTION	LIST
	JC1 BLK	1" Cable J-Clip [Includes Hardware] W 1" D 1.5" H 0.875"	\$10
	MGCC BLK	Flexible Cable Chain [Includes 46 Links; Magnetic/Screw-Mount Base] W 2" D 2" H 37.75"-46.75"	\$302

# SUPPORTS SUPPORTS

IMAGE	CODE	DESCRIPTION	LIST
	BASB72 SLV	42" Support Bar W 41.69" D 1.88" H 0.88"	\$173
	BFB1 SLV	Flat Bracket W 4.69" D 1.94" H 0.06"	\$8

# ACCESSORIES MONITOR ARM + PILLOWS

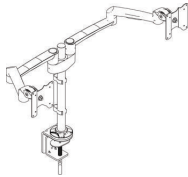
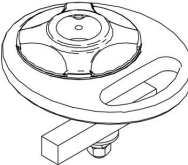
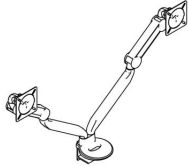
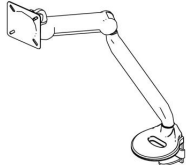
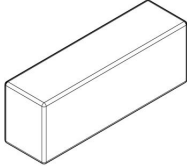
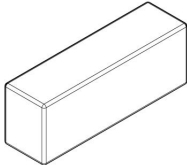
IMAGE	CODE	DESCRIPTION	LIST
	BMA2 BLK, SLV, WHT	Dual Monitor Arm [Includes Edge Mount] W 22"-35" D 4"-22" H 6.5"-20"	\$903
	BMAGM BLK, SLV, WHT	Grommet-Mount Adapter [For Dual Monitor Arm] W 4.72" D 5.51" H 0.5"	\$71
	NXMA BLK, SLV, WHT	NEXUS Dual Monitor Arm [Includes Edge/Grommet Mount and VESA Quick-Release System] W 36.14" D 5.91" H 7.36"-18.39"	\$737
	NXSMA BLK, SLV, WHT	NEXUS Single Monitor Arm [Includes Edge/Grommet Mount and VESA Quick-Release System]	\$397

IMAGE	CODE	DESCRIPTION	LIST
	ABP18-COM	Accent Bolster Pillow 18" W 18 D 5 H 6.5	\$313
	ABP18-UPH MID, AEG, CIT	Accent Bolster Pillow 18" Upholstered W 18 D 5 H 6.5	\$334

# ACCESSORIES POWER & DATA UNITS

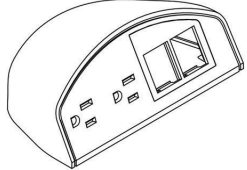
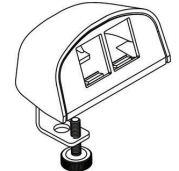
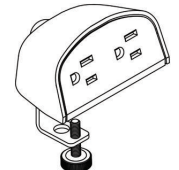
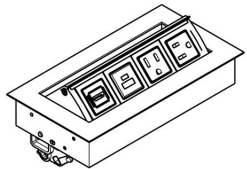
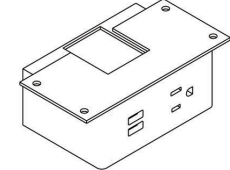
IMAGE	CODE	DESCRIPTION	LIST
Desktop Units 	BMFDAV2 BLK, WHT	Desktop Combo Unit [2 Power Outlets, 2 Data Ports, 72" Cord] W 6.2" D 3.88" H 2.31"	\$377
	BPDMA BLK	Desktop Data Unit [2 Data Ports, 72" Cord] W 3.7" D 2.43" H 1.85"	\$303
	BPMA BLK, WHT	Desktop Power Unit [2 Power Outlets, 72" Cord] W 3.7" D 2.86" H 1.85"	\$303
	DPM112 BLK, WHT	Desktop Power Unit [2 Power Outlet, 1 USB, 1 USB-C, 74" Cord] W 6.125" D 3.5" H 7.0"	\$391
Grommet Units	SGPWR BLK, WHT	Grommet Power Unit [60mm, 1 Power Outlet, 72" Cord] W 2.62" D 2.62" H 0.2"	\$178
	SGUSB BLK, WHT	Grommet USB Unit [60mm, 1 Dual USB, 72" Cord] W 2.62" D 2.62" H 0.2"	\$474
In-Surface Units 	ISPU BLK, SLV, WHT	In-Surface Power Unit [2 Power Outlets, 1 Dual USB A+C, 1 HDMI Port, 72" Cord] W 8.31" D 4.42" H 1.15"	\$1517

IMAGE	CODE	DESCRIPTION	LIST
Under-Surface Units 	BPUSM BLK	Under-Surface Combo Unit [1 Power Outlet, Dual USB, 72" Cord] W 4.05" D 2.77" H 1.69"	\$521

# ACCESSORIES STORAGE HOOK

IMAGE	CODE	DESCRIPTION	LIST
	PSH BLK, SLV, WHT	Personal Storage Hook W 6" D 2.32" H 2.63"	\$37

